

### 3-Electrode Gas Tube Arrester

UN3E5-90LM

φ5×7.6

2.5KA×2

#### Dimension

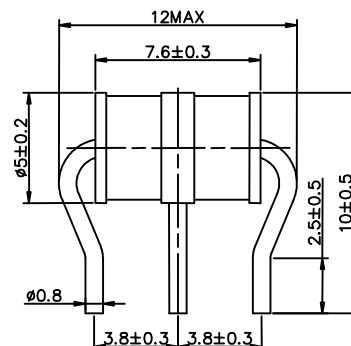
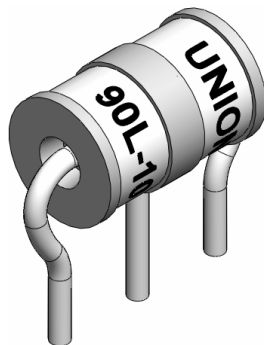

Unit: mm

Nickel-plated

Electrical Specifications			Applications
DC Spark-over Voltage at 100V/S	90±20%	V	<ul style="list-style-type: none"> <li>u Branch exchange(MDF)</li> <li>u Date/Single line protection</li> <li>u Station protection</li> <li>u Telephone / Fax / modem protection</li> <li>u Consumer electronics</li> </ul>
Impulse Spark-over Voltage at 100V/μs at 1KV/μs	<450	V	
	<600	V	
Life: Impulse Discharge current 8/20μs (±5 times) 10/1000μs (300 times) AC Discharge current (1S,5times interval 3 minutes)	2.5×2	KA	
	100	A	
	2.5×2	A	
Insulation resistance at DC 50V	>1000	MΩ	
Electrode Capacitance at 1MHz	<1.5	pF	
Arc Voltage at 1A	~25	V	
Glow Voltage at 1mA	~60	V	
Holdover Voltage at 100mA, <150mS	52	V	
Transverse delay time	< 0.2	μs	
Weight	~0.8	g	
Operation and storage Temperature	-40~+90	°C	
Marking, Black	<p style="text-align: center;"><b>UNION</b> <b>90L-YY</b></p> <p>90 -Nominal voltage L -5KA YY -Year of production</p>		<b>Feature</b> <ul style="list-style-type: none"> <li>u Non-Radioactive</li> <li>u ROHS Compliant</li> <li>u LOW Capacitance</li> <li>u High insulation resistance</li> <li>u Fast response-time</li> <li>u Very small size</li> </ul>

#### Notes:

1. Terms in accordance with ITU-T K.12 and GB/T 9043-2008
2. At delivery AQL 0.65 level II , DIN ISO 2859
3. After life test:  
DC Spark-over Voltage at 100V/S :90±30%  
Impulse Spark-over Voltage at 1KV/μs<700V