

3-Electrode Gas Tube Arrester

UN3E7-600HM

φ 7.5×11.5

10KA×2

Dimension

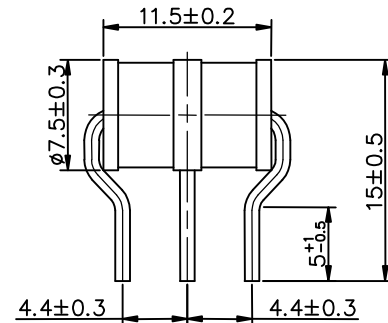
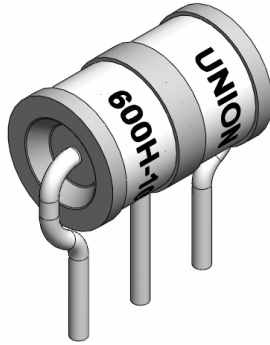

Unit:mm

Nickel-plated

Electrical Specifications			Applications
DC Spark-over Voltage at 100V/S	600±20%	V	<ul style="list-style-type: none"> u Branch exchange(MDF) u Telephone / Fax / modem protection u Date/Single line protection u XDSL-splitter u Cable TV / Coaxial cable protection u Tower mounted amplifier u Consumer electronics
Impulse Spark-over Voltage at 100V/μs	<1100	V	
Impulse Spark-over Voltage at 1KV/μs	<1200	V	
Life:			
Impulse Discharge current 8/20μs (±5 times)	10×2	KA	
10/1000μs (300 times)	100	A	
AC Discharge current (1S,5times interval 3 minutes)	10×2	A	
Insulation resistance at DC 100V	>1000	MΩ	
Electrode Capacitance at 1MHz	<1.5	pF	
Arc Voltage at 1A	~25	V	
Glow Voltage at 1mA	~70	V	Feature <ul style="list-style-type: none"> u Non-Radioactive u RoHS Compliant u LOW Capacitance u High insulation resistance u Fast response-time u Standard size
Holdover Voltage at 100mA, <150mS	150	V	
Transverse delay time	< 0.2	μs	
Weight	~2.5	g	
Operation and storage Temperature	-40~+90	°C	
Marking, Black	UNION 600H-YY 600 -Nominal voltage H -20KA YY -Year of production		

Notes:

1. Terms in accordance with ITU-T K.12 and GB/T 9043-2008
2. At delivery AQL 0.65 level II , DIN ISO 2859
3. After life test:
 DC Spark-over Voltage at 100V/S : 600±30%
 Impulse Spark-over Voltage at 1KV/μs<1300V