

SURFACE MOUNT FAST SWITCHING DIODE

Features

- High Conductance
- Fast Switching Speed
- Surface Mount Package Ideally Suited for Automatic Insertion
- For General Purpose Switching Application
- Plastic Material – UL Recognition Flammability Classification 94V-O

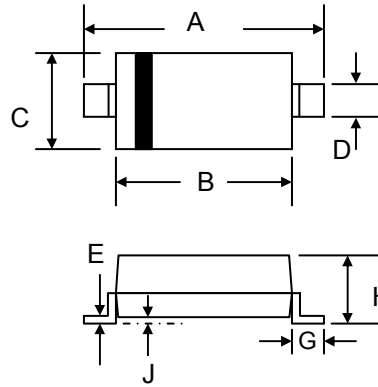

SOD-123		
Dim	Min	Max
A	3.6	3.9
B	2.5	2.8
C	1.4	1.8
D	0.5	0.7
E	—	0.2
G	0.4	—
H	0.95	1.35
J	—	0.12
All Dimensions in mm		

Mechanical Data

- Case: SOD-123, Molded Plastic
- Terminals: Plated Leads Solderable per MIL-STD-202, Method 208
- Polarity: Cathode Band
- Weight: 0.01 grams (approx.)
- Marking: Device Code, See Page 3
- **Lead Free: For RoHS / Lead Free Version, Add “-LF” Suffix to Part Number, See Page 4**

Maximum Ratings and Electrical Characteristics @ $T_A=25^\circ\text{C}$ unless otherwise specified

Characteristic	Symbol	1N4448W	Unit
Non-Repetitive Peak Reverse Voltage	V_{RM}	100	V
Peak Repetitive Reverse Voltage Working Peak Reverse Voltage DC Blocking Voltage	V_{RRM} V_{RWM} V_R	75	V
RMS Reverse Voltage	$V_{R(RMS)}$	53	V
Forward Continuous Current (Note 1)	I_{FM}	500	mA
Average Rectified Output Current (Note 1)	I_O	250	mA
Non-Repetitive Peak Forward Surge Current	I_{FSM}	4.0 2.0	A
Forward Voltage Drop	V_{FM}	0.72 1.0	V
Peak Reverse Leakage Current	I_{RM}	25 5.0	nA μA
Typical Junction Capacitance ($V_R = 0\text{V DC}$, $f = 1.0\text{MHz}$)	C_j	4.0	pF
Reverse Recovery Time (Note 2)	t_{rr}	4.0	nS
Power Dissipation (Note 1)	P_d	500	mW
Typical Thermal Resistance, Junction to Ambient Air (Note 1)	$R_{\theta JA}$	357	K/W
Operating and Storage Temperature Range	T_j, T_{STG}	-65 to +150	$^\circ\text{C}$

Note: 1. Valid provided that terminals are kept at ambient temperature.
2. Measured with $I_F = I_R = 10\text{mA}$, $I_{RR} = 0.1 \times I_R$, $R_L = 100\Omega$.

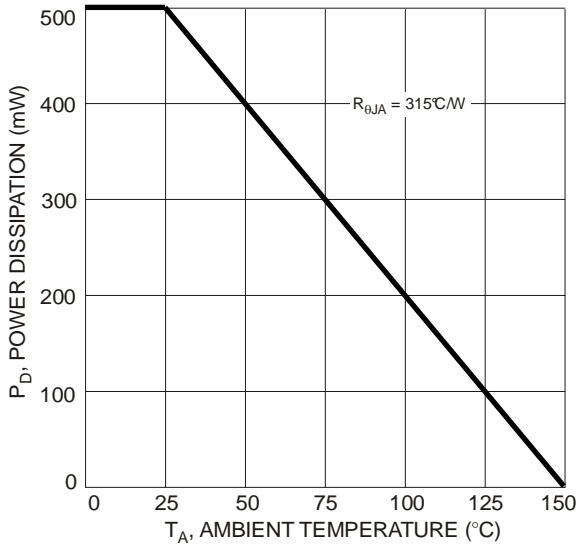

Fig. 1 Power Derating Curve

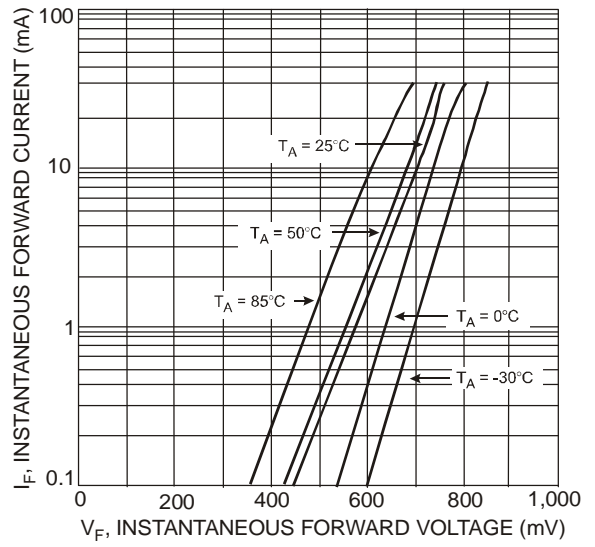

Fig. 2 Typical Forward Characteristics

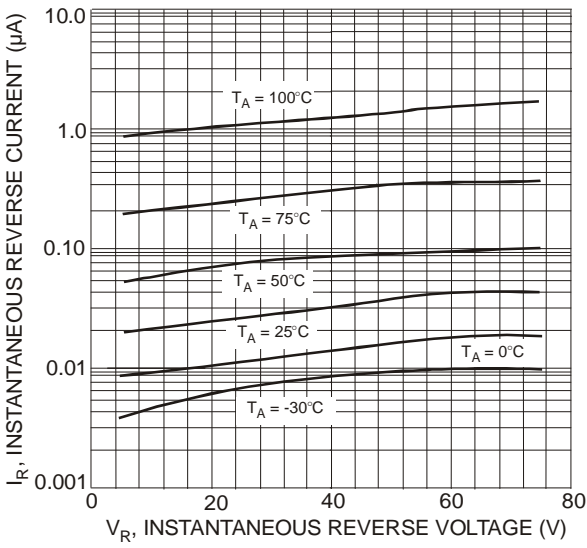

Fig. 3 Typical Reverse Characteristics

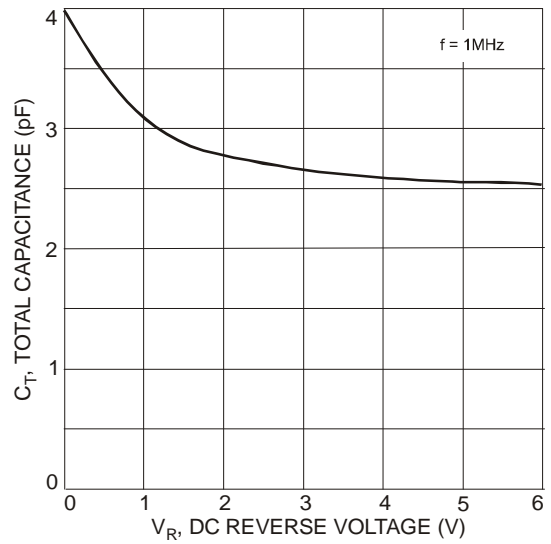

Fig. 4 Total Capacitance vs. Reverse Voltage

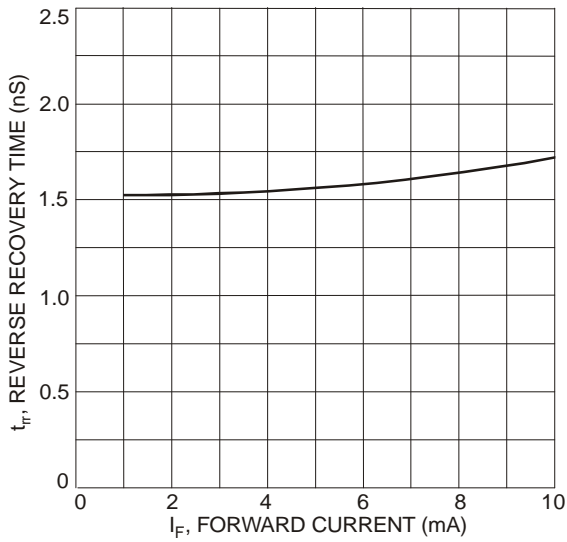

Fig. 5 Reverse Recovery Time vs. Forward Current

MARKING INFORMATION



xx = Device Code, See Table Below

Mfg Site	Device Code
TW Plant	A3
CN Plant	T5

RECOMMENDED FOOTPRINT

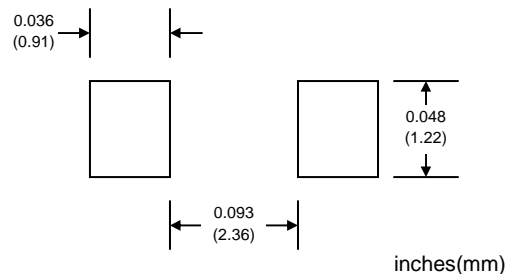

PACKAGING INFORMATION

TAPE & REEL

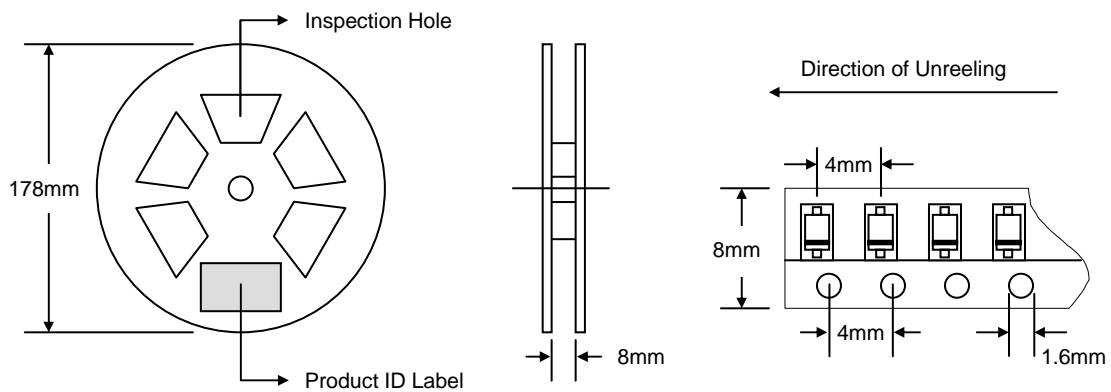

Reel Diameter (mm)	Quantity (PCS)	Inner Box Size L x W x H (mm)	Quantity (PCS)	Carton Size L x W x H (mm)	Quantity (PCS)	Approx. Gross Weight (KG)
178	3,000	187 x 187 x 65	15,000	390 x 240 x 420	150,000	10.0

Note: 1. Anti-static plastic reel, white, water clear or blue color. Inspection hole might be varied in different alignment.
2. Components are packed in accordance with EIA standard 481-1 and 481-2.

ORDERING INFORMATION

Product No.	Package Type	Shipping Quantity
1N4448W-T1	SOD-123	3000/Tape & Reel

1. Shipping quantity given is for minimum packing quantity only. For minimum order quantity, please consult the Sales Department.
2. **To order RoHS / Lead Free version (with Lead Free finish), add "-LF" suffix to part number above. For example, 1N4448W-T1-LF.**

Won-Top Electronics Co., Ltd (WTE) has checked all information carefully and believes it to be correct and accurate. However, WTE cannot assume any responsibility for inaccuracies. Furthermore, this information does not give the purchaser of semiconductor devices any license under patent rights to manufacturer. WTE reserves the right to change any or all information herein without further notice.

WARNING: DO NOT USE IN LIFE SUPPORT EQUIPMENT. WTE power semiconductor products are not authorized for use as critical components in life support devices or systems without the express written approval.

Won-Top Electronics Co., Ltd.

No. 44 Yu Kang North 3rd Road, Chine Chen Dist., Kaohsiung, Taiwan

Phone: 886-7-822-5408 or 886-7-822-5410

Fax: 886-7-822-5417

Email: sales@wontop.com

Internet: <http://www.wontop.com>

We power your everyday.