

Features

- Schottky Barrier Chip
- Guard Ring Die Construction for Transient Protection
- Low Forward Voltage Drop
- Low Power Loss, High Efficiency
- High Surge Current Capability
- For Use in Low Voltage, High Frequency Inverters, Free Wheeling, and Polarity Protection Applications

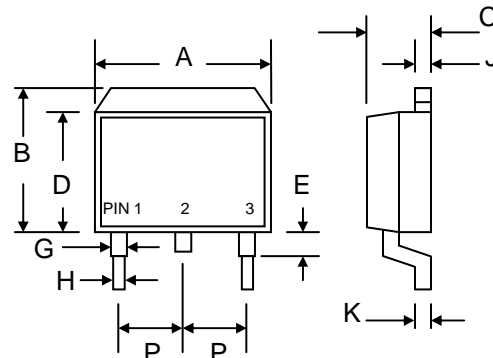

Mechanical Data

- Case: D²PAK/TO-263, Molded Plastic
- Terminals: Plated Leads Solderable per MIL-STD-202, Method 208
- Polarity: See Diagram
- Weight: 1.7 grams (approx.)
- Mounting Position: Any
- Marking: Type Number
- **Lead Free: For RoHS / Lead Free Version, Add "-LF" Suffix to Part Number, See Page 4**

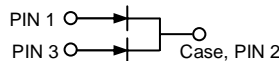

D ² PAK/TO-263		
Dim	Min	Max
A	9.80	10.40
B	9.60	10.60
C	4.40	4.80
D	8.50	9.10
E	2.80	—
G	1.00	1.40
H	—	0.90
J	1.20	1.40
K	0.30	0.70
P	2.35	2.75
All Dimensions in mm		

Maximum Ratings and Electrical Characteristics @T_A=25°C unless otherwise specified

Single Phase, half wave, 60Hz, resistive or inductive load.
For capacitive load, derate current by 20%.

Characteristic	Symbol	SB8150DC	SB8200DC	Unit
Peak Repetitive Reverse Voltage Working Peak Reverse Voltage DC Blocking Voltage	V _{RRM} V _{RWM} V _R	150	200	V
RMS Reverse Voltage	V _{R(RMS)}	105	140	V
Average Rectified Output Current @T _C = 130°C	I _O	8.0		A
Non-Repetitive Peak Forward Surge Current 8.3ms Single half sine-wave superimposed on rated load (JEDEC Method)	I _{FSM}	150		A
Forward Voltage @I _F = 4.0A	V _{FM}	0.92		V
Peak Reverse Current @T _A = 25°C At Rated DC Blocking Voltage @T _A = 100°C	I _{RM}	0.5 50		mA
Typical Junction Capacitance (Note 1)	C _j	400		pF
Typical Thermal Resistance (Note 2)	R _{θJC}	3.0		°C/W
Operating and Storage Temperature Range	T _j , T _{stg}	-65 to +150		°C

Note: 1. Measured at 1.0 MHz and applied reverse voltage of 4.0V D.C.
2. Mounted on minimum recommended pad size on FR-4 board.

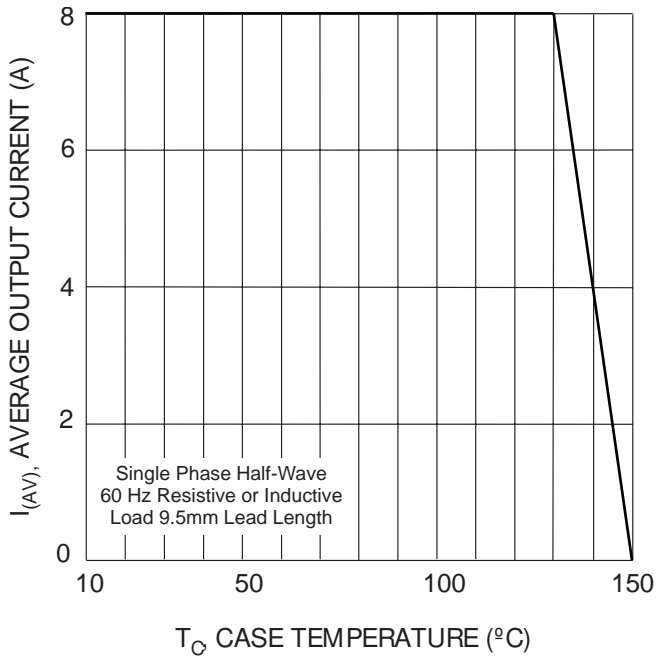

Fig. 1 Forward Current Derating Curve

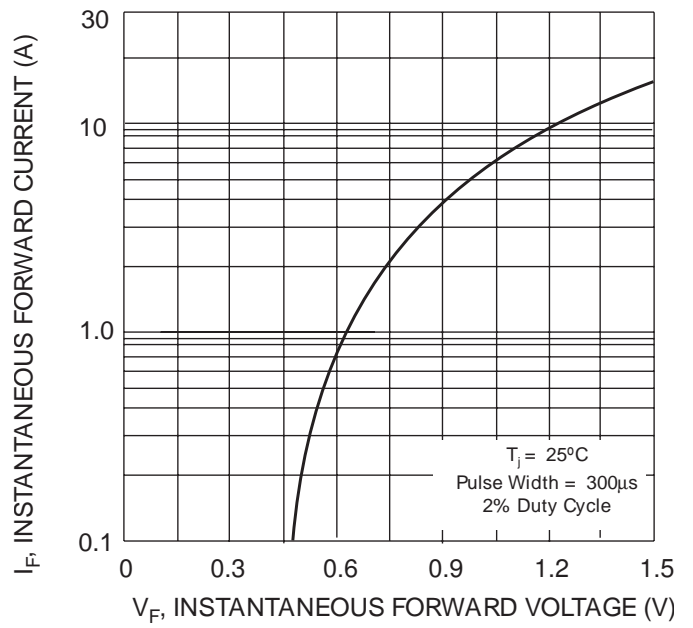

Fig. 2 Typical Forward Voltage Characteristics

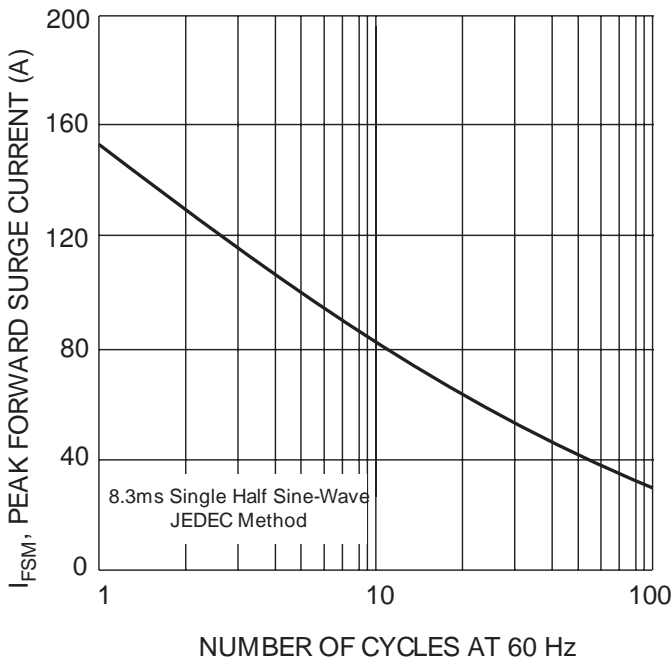

Fig. 3 Peak Forward Surge Current

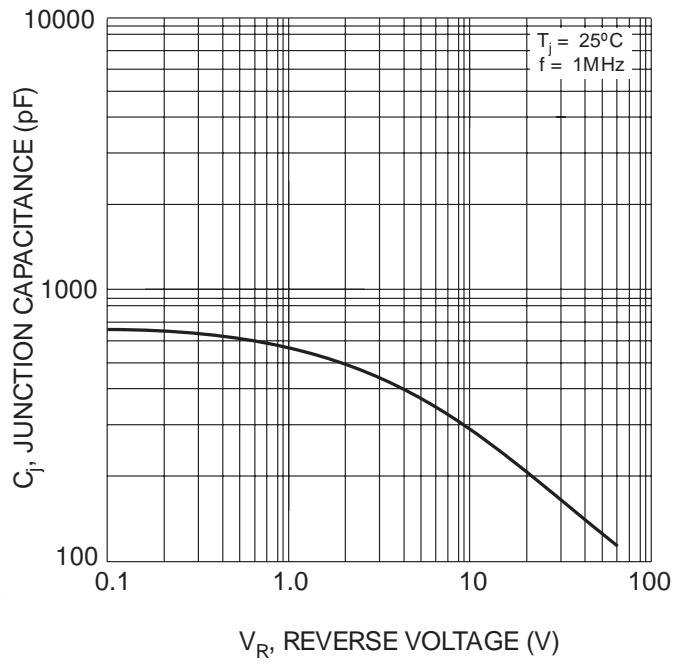
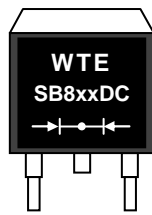

Fig. 4 Typical Junction Capacitance

MARKING INFORMATION



WTE = Manufacturer's Logo
 SB8xxDC = Device Number
 xx = 150 or 200
 Polarity = As Marked on Body

RECOMMENDED FOOTPRINT

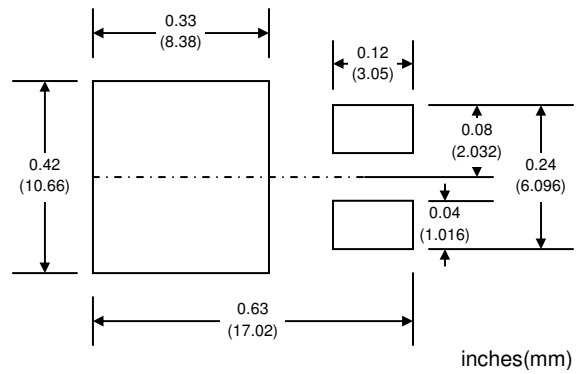

PACKAGING INFORMATION

TAPE & REEL

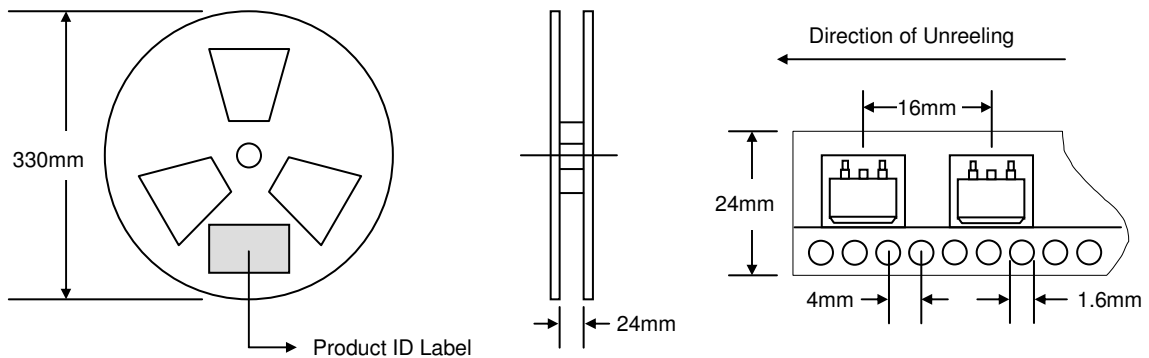

Reel Diameter (mm)	Quantity (PCS)	Inner Box Size L x W x H (mm)	Quantity (PCS)	Carton Size L x W x H (mm)	Quantity (PCS)	Approx. Gross Weight (KG)
330	800	340 x 337 x 45	800	370 x 370 x 420	6,400	15.0

Note: 1. Paper reel, white or gray color.
 2. Components are packed in accordance with EIA standard 481-1 and 481-2.

ORDERING INFORMATION

Product No.	Package Type	Shipping Quantity
SB8150DC-T3	D ² PAK	800/Tape & Reel
SB8200DC-T3	D ² PAK	800/Tape & Reel

1. Shipping quantity given is for minimum packing quantity only. For minimum order quantity, please consult the Sales Department.
2. **To order RoHS / Lead Free version (with Lead Free finish), add "-LF" suffix to part number above. For example, SB8150DC-T3-LF.**

Won-Top Electronics Co., Ltd (WTE) has checked all information carefully and believes it to be correct and accurate. However, WTE cannot assume any responsibility for inaccuracies. Furthermore, this information does not give the purchaser of semiconductor devices any license under patent rights to manufacturer. WTE reserves the right to change any or all information herein without further notice.

WARNING: DO NOT USE IN LIFE SUPPORT EQUIPMENT. WTE power semiconductor products are not authorized for use as critical components in life support devices or systems without the express written approval.

Won-Top Electronics Co., Ltd.

No. 44 Yu Kang North 3rd Road, Chine Chen Dist., Kaohsiung, Taiwan

Phone: 886-7-822-5408 or 886-7-822-5410

Fax: 886-7-822-5417

Email: sales@wontop.com

Internet: <http://www.wontop.com>

We power your everyday.