

8.0A SINGLE-PHASE BRIDGE RECTIFIER

Features

- Diffused Junction
- Low Forward Voltage Drop
- High Current Capability
- High Reliability
- High Surge Current Capability
- Ideal for Printed Circuit Boards
-  Recognized File # E157705

Mechanical Data

- Case: KBJ-6, Molded Plastic
- Terminals: Plated Leads Solderable per MIL-STD-202, Method 208
- Polarity: As Marked on Body
- Weight: 7.4 grams (approx.)
- Mounting Position: Any
- Mounting Torque: 10 cm·kg (8.8 in·lbs) Max.
- **Lead Free: For RoHS / Lead Free Version, Add "-LF" Suffix to Part Number, See Page 4**

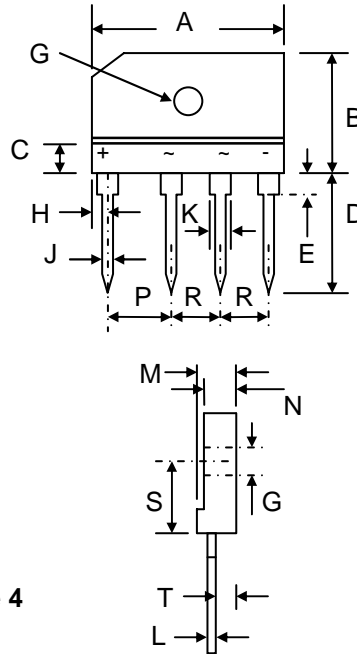

KBJ-6		
Dim	Min	Max
A	29.7	30.3
B	19.7	20.3
C	—	5.0
D	17.0	18.0
E	3.8	4.2
G	3.1Ø	3.4Ø
H	2.3	2.7
J	0.9	1.1
K	1.8	2.2
L	0.6	0.8
M	4.8	5.3
N	4.05	4.35
P	9.8	10.2
R	7.3	7.7
S	10.8	11.2
T	2.3	2.7
All Dimensions in mm		

Maximum Ratings and Electrical Characteristics @T_A=25°C unless otherwise specified

Single Phase, half wave, 60Hz, resistive or inductive load.
For capacitive load, derate current by 20%.

Characteristic	Symbol	KBJ 8A	KBJ 8B	KBJ 8D	KBJ 8G	KBJ 8J	KBJ 8K	KBJ 8M	Unit
Peak Repetitive Reverse Voltage	V _{RRM}								
Working Peak Reverse Voltage	V _{RWM}	50	100	200	400	600	800	1000	V
DC Blocking Voltage	V _R								
RMS Reverse Voltage	V _{R(RMS)}	35	70	140	280	420	560	700	V
Average Rectified Output Current @T _C = 110°C (Note 1)	I _O	8.0							A
Non-Repetitive Peak Forward Surge Current 8.3ms Single half sine-wave superimposed on rated load (JEDEC Method)	I _{FSM}	200							A
Forward Voltage per diode @I _F = 4.0A	V _{FM}	1.0							V
Peak Reverse Current @T _A = 25°C	I _R	10							μA
At Rated DC Blocking Voltage @T _A = 125°C		250							
Typical Thermal Resistance per leg (Note 2)	R _{θJA}	26							°C/W
Typical Thermal Resistance per leg (Note 1)	R _{θJC}	2.8							°C/W
Operating and Storage Temperature Range	T _J , T _{STG}	-55 to +150							°C

Note: 1. Device mounted on 100 x 100 x 1.6mm thick Al plate heatsink.
2. Device mounted on P.C.B. without heatsink.

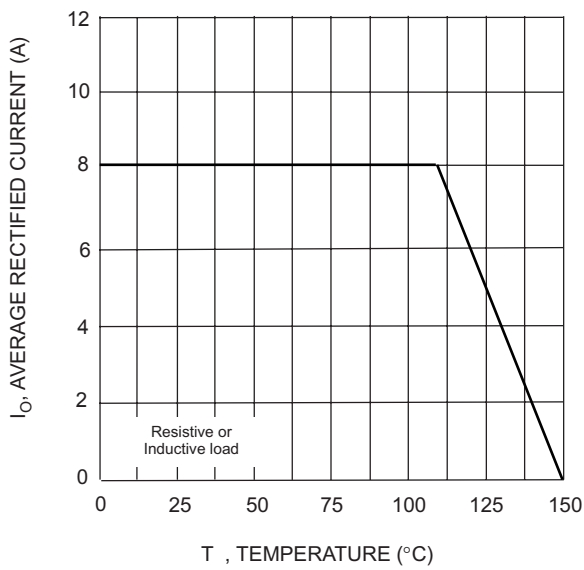

Fig. 1 Forward Current Derating Curve

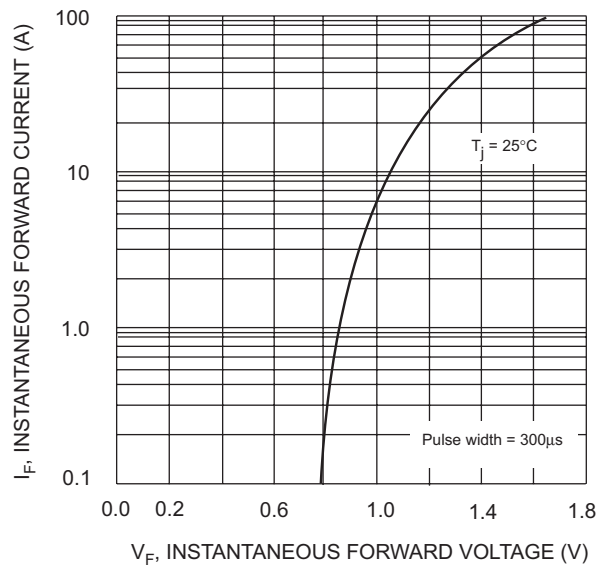

Fig. 2 Typical Fwd Characteristics

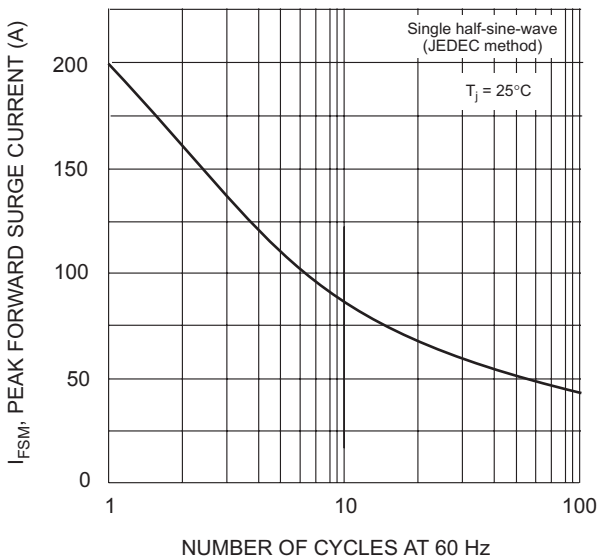

Fig. 3 Maximum Non-Repetitive Surge Current

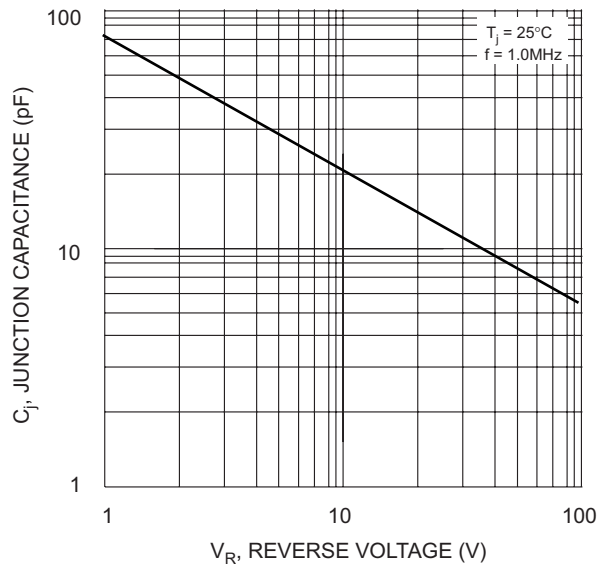
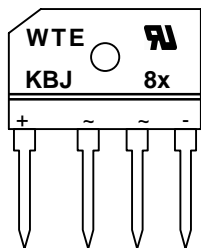

Fig. 4 Typical Junction Capacitance

MARKING INFORMATION



WTE = Manufacturer's Logo
 KBJ8x = Device Number
 x = A, B, D, G, J, K or M
 Polarity = As Marked on Body

PACKAGING INFORMATION

BULK

Tube Size L x W x H (mm)	Quantity (PCS)	Inner Box Size L x W x H (mm)	Quantity (PCS)	Carton Size L x W x H (mm)	Quantity (PCS)	Approx. Gross Weight (KG)
475 x 40 x 7	15	490 x 145 x 135	750	510 x 305 x 160	1,500	17.0

Note: 1. Anti-static tube, water clear color.

ORDERING INFORMATION

Product No.	Package Type	Shipping Quantity
KBJ8A	SIL Bridge	15 Units/Tube
KBJ8B	SIL Bridge	15 Units/Tube
KBJ8D	SIL Bridge	15 Units/Tube
KBJ8G	SIL Bridge	15 Units/Tube
KBJ8J	SIL Bridge	15 Units/Tube
KBJ8K	SIL Bridge	15 Units/Tube
KBJ8M	SIL Bridge	15 Units/Tube

1. Shipping quantity given is for minimum packing quantity only. For minimum order quantity, please consult the Sales Department.
2. **To order Lead Free version (with Lead Free finish), add "-LF" suffix to part number above. For example, KBJ8A-LF.**

Won-Top Electronics Co., Ltd (WTE) has checked all information carefully and believes it to be correct and accurate. However, WTE cannot assume any responsibility for inaccuracies. Furthermore, this information does not give the purchaser of semiconductor devices any license under patent rights to manufacturer. WTE reserves the right to change any or all information herein without further notice.

WARNING: DO NOT USE IN LIFE SUPPORT EQUIPMENT. WTE power semiconductor products are not authorized for use as critical components in life support devices or systems without the express written approval.

Won-Top Electronics Co., Ltd.

No. 44 Yu Kang North 3rd Road, Chine Chen Dist., Kaohsiung, Taiwan

Phone: 886-7-822-5408 or 886-7-822-5410

Fax: 886-7-822-5417

Email: sales@wontop.com

Internet: <http://www.wontop.com>

We power your everyday.