

## 2.0A GLASS PASSIVATED SINGLE-PHASE BRIDGE RECTIFIER

### Features

- Glass Passivated Die Construction
- Low Forward Voltage Drop
- High Current Capability
- High Reliability
- High Surge Current Capability
- Ideal for Printed Circuit Boards
-  Recognized File # E157705

### Mechanical Data

- Case: GBP, Molded Plastic
- Terminals: Plated Leads Solderable per MIL-STD-202, Method 208
- Polarity: As Marked on Body
- Weight: 1.7 grams (approx.)
- Mounting Position: Any
- Marking: Type Number
- **Lead Free: For RoHS / Lead Free Version, Add "-LF" Suffix to Part Number, See Page 4**

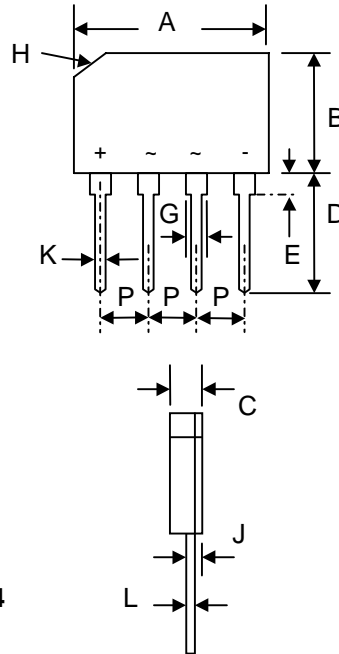

GBP		
Dim	Min	Max
A	14.25	14.75
B	10.10	10.50
C	3.35	3.65
D	14.15	14.65
E	2.10	2.50
G	1.15	1.45
H	2.80 x 45°	
J	1.30	1.60
K	0.66	0.86
L	0.35	0.65
P	3.56	4.06
All Dimensions in mm		

### Maximum Ratings and Electrical Characteristics @ $T_A=25^\circ\text{C}$ unless otherwise specified

Single Phase, half wave, 60Hz, resistive or inductive load.  
For capacitive load, derate current by 20%.

Characteristic	Symbol	GBP 200	GBP 201	GBP 202	GBP 204	GBP 206	GBP 208	GBP 210	Unit
Peak Repetitive Reverse Voltage	$V_{RRM}$								
Working Peak Reverse Voltage	$V_{RWM}$	50	100	200	400	600	800	1000	V
DC Blocking Voltage	$V_R$								
RMS Reverse Voltage	$V_{R(RMS)}$	35	70	140	280	420	560	700	V
Average Rectified Output Current @ $T_A = 50^\circ\text{C}$	$I_O$	2.0							A
Non-Repetitive Peak Forward Surge Current 8.3ms Single half sine-wave superimposed on rated load (JEDEC Method)	$I_{FSM}$	60							A
Forward Voltage per leg @ $I_F = 1.0\text{A}$	$V_{FM}$	1.0							V
Peak Reverse Current @ $T_A = 25^\circ\text{C}$ At Rated DC Blocking Voltage @ $T_A = 125^\circ\text{C}$	$I_R$	5.0 500							$\mu\text{A}$
Typical Thermal Resistance per leg (Note 1)	$R_{\theta JA}$	32							$^\circ\text{C/W}$
Typical Thermal Resistance per leg (Note 2)	$R_{\theta JL}$	13							$^\circ\text{C/W}$
Operating and Storage Temperature Range	$T_j, T_{STG}$	-55 to +150							$^\circ\text{C}$

Note: 1. Mounted on 75 x 75 x 3.0mm Al. plate.  
2. Mounted on PCB at 9.5mm lead length with 12mm<sup>2</sup> copper pad.

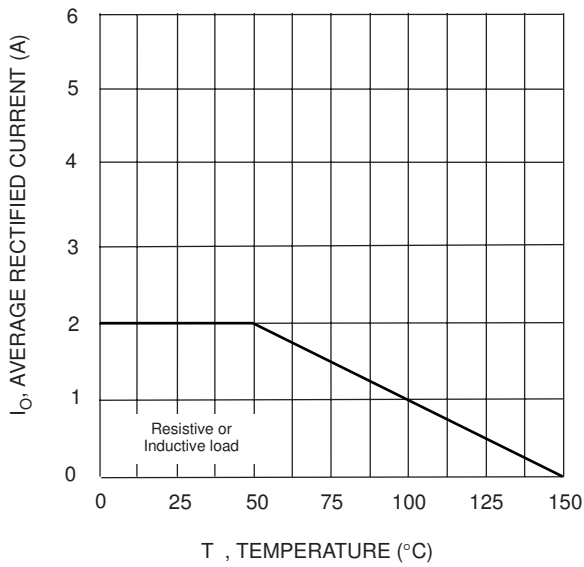

Fig. 1 Forward Current Derating Curve

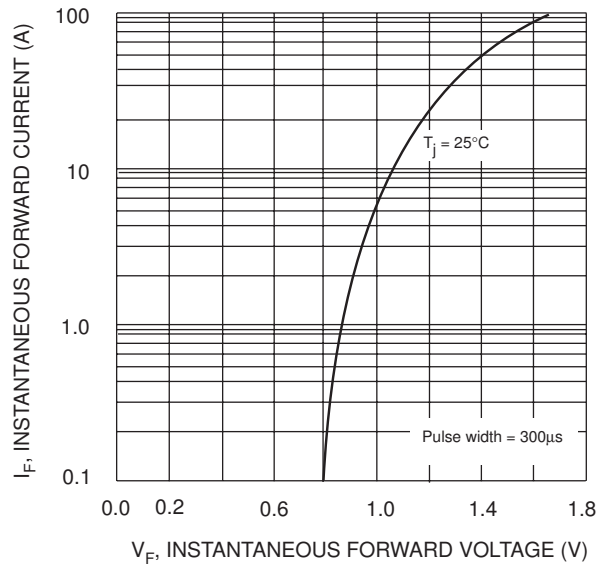

Fig. 2 Typical Fwd Characteristics, per element

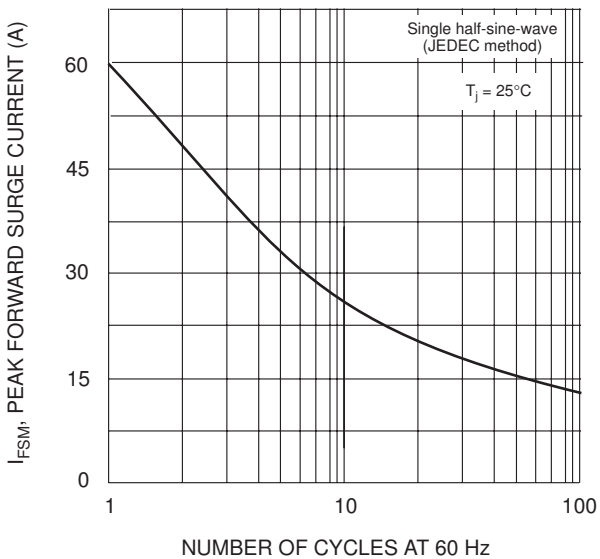

Fig. 3 Maximum Non-Repetitive Surge Current

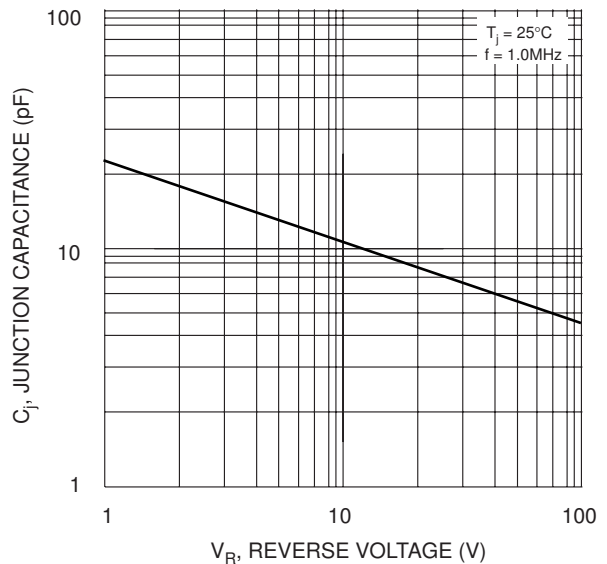
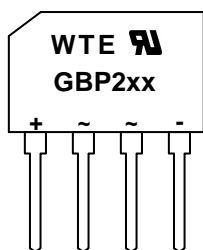

Fig. 4 Typical Junction Capacitance

## MARKING INFORMATION



WTE = Manufacturer's Logo  
 GBP2xx = Device Number  
 xx = 00, 01, 02, 04, 06, 08 or 10  
 Polarity = As Marked on Body

## PACKAGING INFORMATION

### BULK

Tube Size L x W x H (mm)	Quantity (PCS)	Inner Box Size L x W x H (mm)	Quantity (PCS)	Carton Size L x W x H (mm)	Quantity (PCS)	Approx. Gross Weight (KG)
390 x 29 x 6	25	408 x 158 x 70	1,250	430 x 330 x 165	5,000	13.0

**Note:** 1. Anti-static tube, water clear color.

## ORDERING INFORMATION

Product No.	Package Type	Shipping Quantity
GBP200	SIL Bridge	25 Units/Tube
GBP201	SIL Bridge	25 Units/Tube
GBP202	SIL Bridge	25 Units/Tube
GBP204	SIL Bridge	25 Units/Tube
GBP206	SIL Bridge	25 Units/Tube
GBP208	SIL Bridge	25 Units/Tube
GBP210	SIL Bridge	25 Units/Tube

1. Shipping quantity given is for minimum packing quantity only. For minimum order quantity, please consult the Sales Department.
2. **To order Lead Free version (with Lead Free finish), add "-LF" suffix to part number above. For example, GBP200-LF.**

Won-Top Electronics Co., Ltd (WTE) has checked all information carefully and believes it to be correct and accurate. However, WTE cannot assume any responsibility for inaccuracies. Furthermore, this information does not give the purchaser of semiconductor devices any license under patent rights to manufacturer. WTE reserves the right to change any or all information herein without further notice.

**WARNING:** DO NOT USE IN LIFE SUPPORT EQUIPMENT. WTE power semiconductor products are not authorized for use as critical components in life support devices or systems without the express written approval.

**Won-Top Electronics Co., Ltd.**

No. 44 Yu Kang North 3rd Road, Chine Chen Dist., Kaohsiung, Taiwan

**Phone:** 886-7-822-5408 or 886-7-822-5410

**Fax:** 886-7-822-5417

**Email:** sales@wontop.com

**Internet:** <http://www.wontop.com>

*We power your everyday.*