

3rd ANG PROJECTION

ALL DIMS IN MM UNLESS STATED

REV	DESCRIPTION	DATE	APPROVED
1	INITIAL ISSUE	14/08/96	DNL
2	MATL. SPEC. CHANGE	19/12/01	CN10

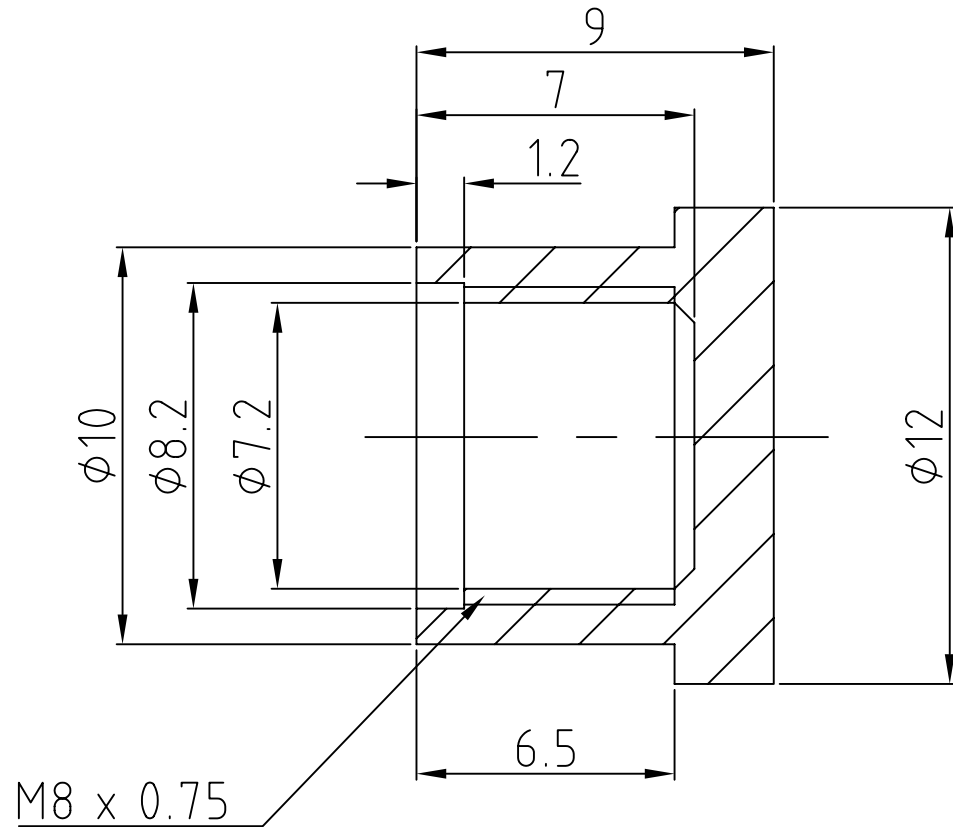
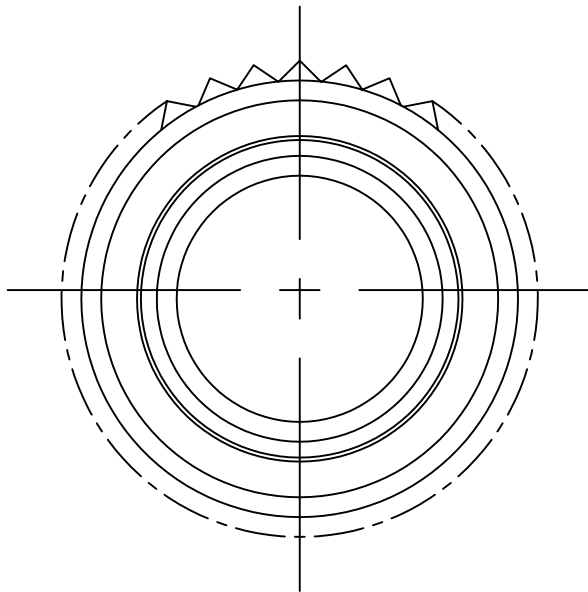

NOTES:

EUROPLUS FIBRE OPTICS
 Thompson Drive, AIA, Rendlesham, Woodbridge, Suffolk IP12 2TW
 Tel: (01394) 445100 Fax: (01394) 445109

GEN TOLS 0 = +/-0.5 0.0 = +/-0.3 0.00 = +/-0.1	DESCRIPTION FC PLASTIC DUST CAP
---	------------------------------------

MATERIAL H.D.P.E	THIS DOCUMENT CONTAINS PROPRIETARY INFORMATION WHICH SHALL NOT BE REPRODUCED, TRANSFERRED TO OTHER DOCUMENTS, DISCLOSED TO OTHERS USED FOR MANUFACTURING OR ANY OTHER PURPOSE WITHOUT THE WRITTEN AUTHORISATION OF EUROPLUS FIBRE OPTICS Ltd.	DRAWN CDD	DATE 150796	SIZE	FILE NAME	DWG. No	REV.
FINISH CBGF		CHKD DNL	DATE 150796		0203003	EFA02 03 003	2
ICE No:		DO NOT SCALE DRAWING	SCALE 5:1	SHEET 1 of 1			