

8LT Series

MIL-DTL-38999 Series I

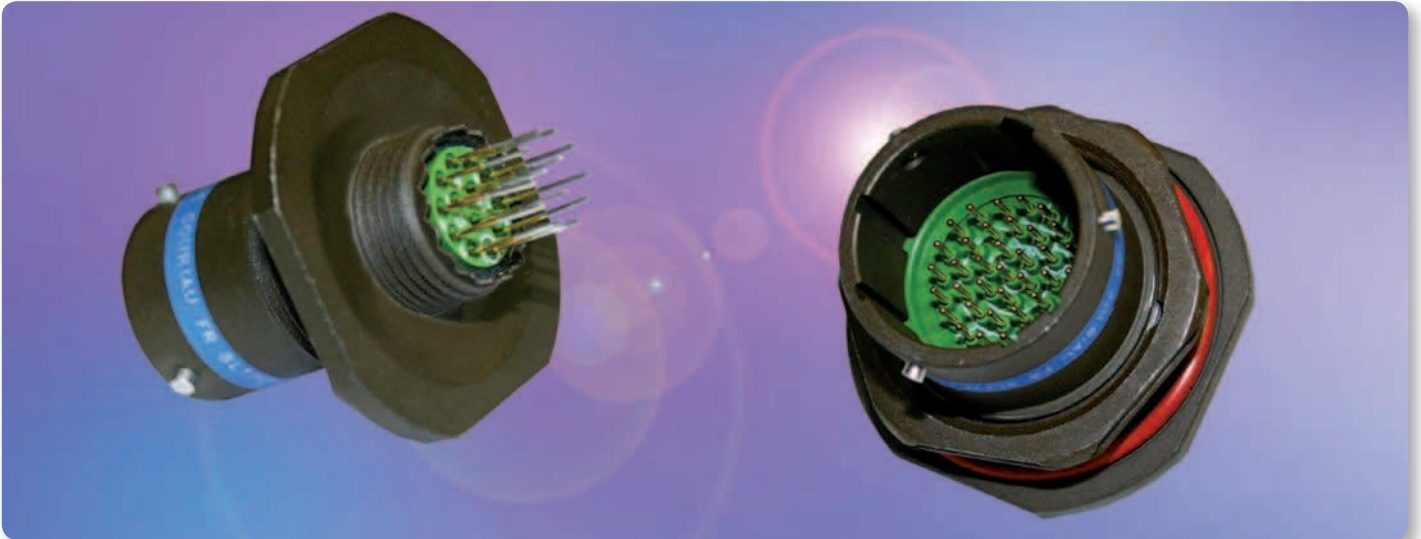



Presentation

High contact density connectors with high reliability

This 8LT product family is qualified in accordance to the MIL-DTL-38999 series I.

Originally designed to meet the high performance needs of the aerospace industries & military applications, it is also now used in varied applications needing extremely reliable interconnections with high density contact arrangements in a miniature circular shell.

Benefit to the customer

- Weight and Space Saving
- Quick Mating - 3 point bayonet lock system
- Mismatching, error proof positioning - keyway polarization (5 positions)
- High choice of Insert arrangements (customization possible, please consult us)
- Range extension available or on demand (Rack Panel, Potted, Hermetics, Low Profile, Filters, etc..), please consult us
- Versatility thanks to our inserts as for the series III (except for 8LT type 2) with full range of crimp contacts interchangeable
- Gold plated crimp or spill contacts are rear removable and retained in the insulator by a metal clip.
- RoHS version available (cadmium free)



Contents

• Presentation	03
• Technical features & benefits	05
• Cross reference list	
Connectors	06
Backshells	06
Caps	07
Contacts	07
Filler plug	07
Insertion & extraction tools	07
• Mated connectors with backshells	08
• Plug or receptacle backshell assembly overall length	10
• Mated connectors dimensions	11
• Contact layouts	14
• Contact layouts (matrix)	18
• Part numbers	
Souriau connector	20
MIL-DTL-38999 connector	21
HE 308 connector	22
• Dimensions	23
• Rack & panel	
Souriau connector part numbers	28
HE 308 connector part numbers	28
Features & benefits	29
Dimensions	30
Panel cut	31
• Contacts	
Crimp contacts	32
Reducers	34
Boots	34
PC tail contacts	34
Wire wrap contacts	35
Solder cup	35
Quadrax #8 contacts	35
Thermocouple contacts	36
• Orientations	37
• Accessories	
Protective caps	38
Dummy receptacle	39
Panel gasket	40
• Tooling	40
• Wiring instructions	42
• Backshells	44
• Cost effective & light hermetic / Resin sealed	46
• Coordinates for PC tail terminations	48



Description

- High contact density
- Bayonet coupling
- Contact protection : 100% Scoop proof
- Shell size from 9 to 25
- Accessories available (protective caps, backshells, etc...)
- RFI - EMI shielding and shell to shell continuity
- Hermetic
- Aluminium alloy, protection by cadmium, nickel, green zinc cobalt or black zinc nickel plating

Applications

- Civil and Military Aerospace
- Marine Equipments
- Communications Equipements
- Medical Instrumentation
- Ballistic Missiles & Weapon Systems
- Armored Carriers & Tanks
- Test Equipments

Technical features

Mechanical

- Shell: aluminum alloy
- Plating:
 - . olive green cadmium (B)
 - . nickel (F)
 - . green zinc cobalt (Z)
 - . black zinc nickel (L)
- Insulator: thermoplastic or metallic version available for specification 284 & 384
- Grommet or seal: liquid silicone rubber or fluorocarbene elastomer for specification 022
- Contact: copper alloy
- Plating contact: gold over nickel
- Endurance: 500 mating / unmating operations

- Chock: 300 g during 3 ms and as per MIL S 901 grade A
- Vibration:
 - . Sine 10 to 2000 Hz - 30 g
 - . Random 100 à 300 Hz - 5 g²/Hz
- Contact retention (min force in N):
 - . Size 22D: 44 N
 - . Size 20: 67 N
 - . Size 16: 111 N
 - . Size 12: 111 N
 - . Size 8: 111 N
 - . Size 4: 200 N

Electrical

- Test voltage (Vrms)

Service	sea level	at 21 000 m
M	1 300	800
N	1 000	600
I	1 800	1 000
II	2 300	1 000

- Insulation resistance: $\geq 5\ 000\ MW$ (at 500 Vcc)
- Contact resistance:
 - resistance of wire included in measurement
 - . size 22D: 14.6 m Ω
 - . size 20: 7.3 m Ω
 - . size 16: 3.8 m Ω
 - . size 12: 3.5 m Ω
 - . size 8: 3 m Ω
 - . size 4: 2 m Ω
- Contact rating:
 - . size 22D: 5 A
 - . size 20: 7.5 A
 - . size 16: 13 A
 - . size 12: 23 A
 - . size 8: 45 A
 - . size 4: 80 A
- Shell continuity:
 - . olive green plating: 2.5 m Ω
 - . nickel plating: 1 m Ω
 - . green zinc cobalt: 2.5 m Ω
 - . black zinc nickel: 2.5 m Ω

- Shielding: 90 db at 100 MHz, 50 db at 10 000 MHz
- Electrical continuity between contact and shell for specification 284 & 384: 10 m Ω max

Climatic

- Temperature range:
 - . olive green cadmium plating (B)
 - 65°C +175°C
 - . nickel plating (F)
 - 65°C +200°C
 - . green zinc cobalt plating (Z)
 - 65°C +200°C
 - . black zinc nickel plating (L)
 - 65°C +200°C
- Sealing: mated connectors
Differential pressure 2 bars:
leakage $\leq 16\ cm^3/h$
- Salt spray as per:
 - . MIL STD 1344 method 1001 :
 - 500 hours (versions B, L and Z)
 - 48 hours (version F)
 - . NFC 93422 :
 - 48 hours (version F)
- Resistance to fluids
 - . As per MIL DTL 38999, hydraulic fluids, solvents
 - . Specification 022 for fuel immersion (please consult us)

8LT Series



Cross reference list :

Part Numbers Souriau and Specifications : NFC 93422 / MIL DTL 38999

Connectors

SOURIAU	NFC 93422 HE 308	MIL DTL 38999 Serie I	Designation
8LT0●●B●●P/SN 8LT0●●F●●P/SN	HE30800T●●●●●P/SN7 M HE30800T●●●●●P/SN6 M	MS27466T●●B●●P/S●* MS27466T●●F●●P/S●*	Square flange receptacle
8LT1●●B●●P/SN 8LT1●●F●●P/SN	- -	- -	Cable connecting receptacle
8LT2●●B●●P/SN 8LT2●●F●●P/SN	- -	MS27505E●●B●●P/S●* MS27505E●●F●●P/S●*	Square flange receptacle not accepting backshell
8LT3●●B●●P/SN 8LT3●●F●●P/SN	- -	MS27656T●●B●●P/S●* MS27656T●●F●●P/S●*	Square flange receptacle (rear mounting)
8LT5●●B●●P/SN 8LT5●●F●●P/SN	HE30806T●●●●●P/SN7 M HE30806T●●●●●P/SN6 M	MS27467T●●B●●P/S●* MS27467T●●F●●P/S●*	Plug with RFI shielding
8LT15●●B●●P/SN 8LT15●●F●●P/SN	- -	MS27467E●●B●●P/S●* MS27467E●●F●●P/S●*	Plug with RFI shielding not accepting backshell
8LT7●●B●●P/SN 8LT7●●F●●P/SN	HE30807T●●●●●P/SN7 M HE30807T●●●●●P/SN6 M	MS27468T●●B●●P/S●* MS27468T●●F●●P/S●*	Jam nut receptacle
8LT7S●●B●●P/SN (#22D) 8LT7S●●F●●P/SN (#22D)	HE30811T●●●●●P/SN7 M HE30811T●●●●●P/SN6 M	- -	Jam nut receptacle with PC Tail contacts
8LT7C●●B●●P/SN (#20, #16, #12) 8LT7C●●F●●P/SN (#20, #16, #12)	HE30811T●●●●●P/SN7 M HE30811T●●●●●P/SN6 M	- -	Jam nut receptacle with PC Tail contacts
8LT26●●B●●P/SN 8LT26●●F●●P/SN	HE30826T●●●●●P/SN7 M -	- -	Floating plug for rack HE308
8LT27●●B●●P/SN 8LT27●●F●●P/SN	HE30827T●●●●●P/SN7 M -	- -	Receptacle for rack HE308 with possibility to mount rear accessories
8LT27S●●B●●P/SN (#22D) 8LT27C●●B●●P/SN (#20, #16, #12)	HE30821T●●●●●P/SN7 M HE30821T●●●●●P/SN7 M	- -	Receptacle for rack HE308 with PC Tail contacts
8LT23●●B●●P/SN	-	-	Square flange receptacle

* Standard P/S : . None = N position,
. Use A,B,C,D for other orientations

Backshells

SOURIAU	NFC 93422 HE 308	MIL DTL 38999 Serie I	Designation
8LST●●●B01 8LST●●●F01	- -	M8504927●●W M8504927●●N	Backnut
8LST●●●B02 8LST●●●F02 8LST●●●G02	- HE308-11●●●26 HE308-11●●●27	- - -	Straight cable clamp
8LST●●●B03 8LST●●●F03 8LST●●●G03	- HE308-12●●●26 HE308-12●●●27	- - -	Elbow cable clamp
8LST●●●B071 8LST●●●F071	HE308-13●●●17 HE308-13●●●16	- -	Backshell for screen termination and heatshrink sleeving

8LT Series



Caps

SOURIAU	NFC 93422 / HE 308	MIL DTL 38999 Serie I	Designation
8LTE04B●● 8LTE04F●●	HE308-B00●●7 HE308-B00●●6	- -	Cap for square flange receptacle
8LTE06B●● 8LTE06F●●	HE308-B07●●7 HE308-B07●●6	- -	Cap for jam nut receptacle
8LTF05B●● 8LTF05F●●	HE308-B16●●7 HE308-B16●●6	- -	Cap for plug
8LTF07B●● 8LTF07F●●	HE308-B06●●7 HE308-B06●●6	- -	Cap for plug
8LTE01B●● 8LTE01F●●	- -	MS27502B●●C MS27502F●●C	Cap for receptacle
8LTE02B●● 8LTE02F●●	- -	MS27502B●●N MS27502F●●N	Cap for receptacle
8LTF01B●● 8LTF01F●●	- -	MS27501B●●C MS27501F●●C	Cap for plug

Contacts

See pages 32 to 36

Filler plug

Contact size	Part Number		Colour
	SOURIAU	MIL DTL 38999 serie I	
#22D	8660-212	MS27488-22	Black
#20	8522-389A	MS27488-20	Red
#16	8522-390A	MS27488-16	Blue
#12	8522-391A	MS27488-12	Yellow

Insertion and extraction tools

Contact size	Part Number		Colour	
	SOURIAU	MIL DTL 38999 Serie I	Insertion	Extraction
#22D	8599-0022	M81969/14-01	Green	White
#20	8522-20	M81969/14-10	Red	Orange
#16	8522-16	M81969/14-03	Blue	White
#12	8522-12	M81969/14-04	Yellow	White

For other contact size see page 41



Mated connectors with backshells

Mated plug : Dimension from panel to backshell

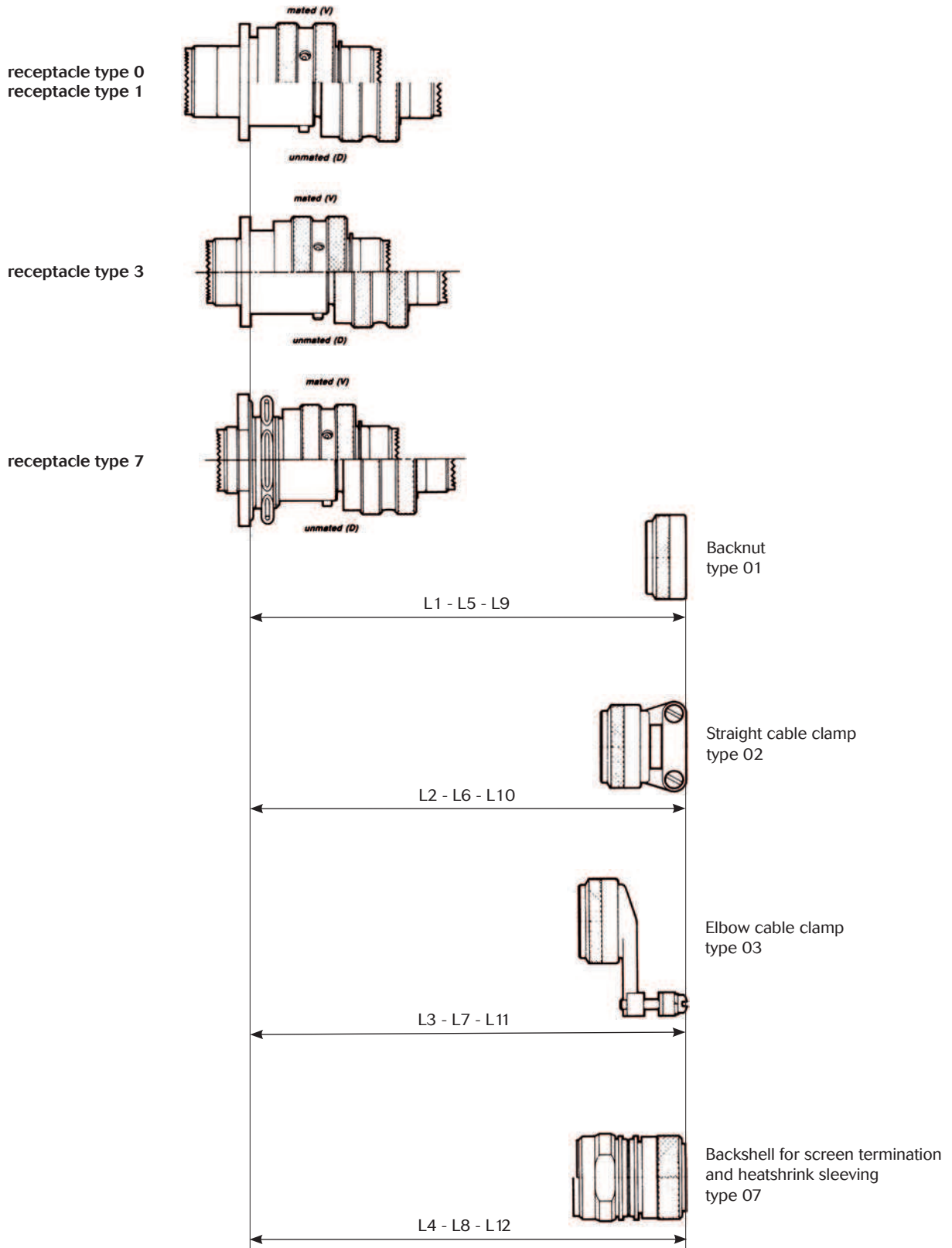

8LT Series



Square flange receptacle type 0 Cable connecting receptacle type 1								
Shell size	L1 Max		L2 Max		L3 Max		L4 Max	
	V	D	V	D	V	D	V	D
09	40.20	55.20	50.75	65.75	64.20	79.20	55.75	70.75
11	40.20	55.20	51.75	66.55	64.20	79.20	55.75	70.75
13	40.20	55.20	53.05	68.05	66.20	81.20	55.75	70.75
15	40.20	55.20	59.45	74.45	70.56	85.56	57.75	72.75
17	40.20	55.20	62.95	77.95	74.93	89.93	57.75	72.75
19	40.20	55.20	62.95	77.95	75.34	90.34	58.75	73.75
21	40.20	55.20	62.95	77.95	77.32	92.32	62.55	77.55
23	40.20	55.20	62.95	77.95	80.87	95.87	62.55	77.55
25	40.20	55.20	62.95	77.95	83.67	98.67	62.55	77.55

Square flange receptacle type 3								
Shell size	L5 Max		L6 Max		L7 Max		L8 Max	
	V	D	V	D	V	D	V	D
09	42.50	57.50	53.05	68.05	66.50	81.50	58.05	72.05
11	42.50	57.50	54.05	68.05	66.50	81.50	58.05	72.05
13	42.50	57.50	55.80	7.35	65.50	83.50	58.05	72.05
15	42.50	57.50	61.75	76.75	78.86	87.86	60.05	75.05
17	42.50	57.50	65.25	80.25	77.23	92.23	60.05	75.05
19	42.50	57.50	65.25	80.25	77.64	92.64	61.05	76.05
21	41.75	56.75	64.50	79.50	78.87	93.87	64.10	79.10
23	41.75	56.75	64.50	79.50	82.42	97.42	64.10	79.10
25	41.75	56.75	64.50	79.50	85.22	100.22	64.10	79.10

Jam nut receptacle type 7								
Shell size	L9 Max		L10 Max		L11 Max		L12 Max	
	V	D	V	D	V	D	V	D
09	45.02	60.02	55.58	70.58	69.04	84.04	60.58	75.58
11	45.02	60.02	56.38	71.38	69.04	84.04	60.58	75.58
13	45.02	60.02	57.88	72.88	71.02	84.04	60.58	75.58
15	45.02	60.02	64.28	79.28	75.39	86.02	62.58	77.58
17	45.02	60.02	67.78	82.78	79.76	90.39	62.58	77.58
19	45.02	60.02	67.78	82.78	80.17	94.76	63.58	78.58
21	45.02	60.02	67.78	82.78	82.15	95.17	67.38	82.38
23	45.02	60.02	67.78	82.78	85.70	100.70	67.38	82.38
25	45.02	60.02	67.78	82.78	88.50	103.50	67.38	82.38



Plug or receptacle backshell assembly overall length

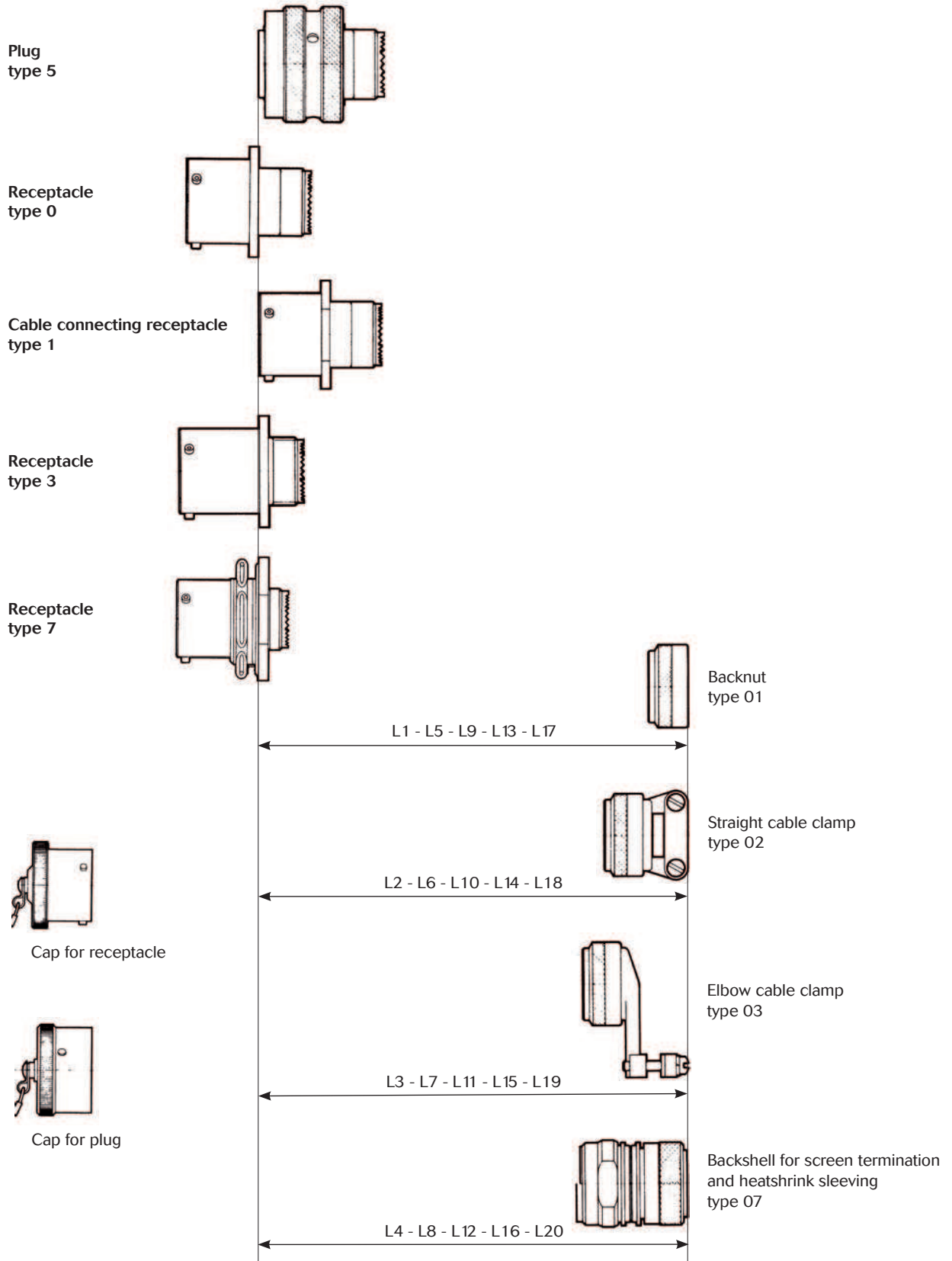

8LT Series



Plug type 5				
Shell size	L1 Max	L2 Max	L3 Max	L4 Max
09	36.66	47.22	60.68	52.22
11	36.66	48.02	60.68	52.22
13	36.66	49.52	62.66	52.22
15	36.66	55.92	67.03	54.22
17	36.66	59.42	71.40	54.22
19	36.66	59.42	71.81	55.22
21	36.66	59.42	73.79	59.02
23	36.66	59.42	77.34	59.02
25	36.66	59.42	80.14	59.02

Receptacle type 0				
Shell size	L5 Max	L6 Max	L7 Max	L8 Max
09	18.83	29.39	42.85	34.39
11	18.83	30.19	42.85	34.39
13	18.83	31.69	44.83	34.39
15	18.83	38.09	51.00	36.39
17	18.83	41.59	53.57	36.39
19	18.83	41.59	53.98	37.39
21	18.83	41.59	55.98	41.19
23	18.83	41.59	59.51	41.19
25	18.83	41.59	62.31	41.19

Cable connecting receptacle type 1				
Shell size	L9 Max	L10 Max	L11 Max	L12 Max
09	37.36	47.98	61.38	52.92
11	37.36	48.72	61.38	52.92
13	37.36	50.22	63.36	52.92
15	37.36	56.62	69.53	54.92
17	37.36	60.12	72.10	54.92
19	37.36	60.12	72.51	55.92
21	37.36	60.12	74.49	59.72
23	37.36	60.12	78.04	59.72
25	37.36	60.12	80.84	59.72

Receptacle type 3				
Shell size	L13 Max	L14 Max	L15 Max	L16 Max
09	15.85	26.40	39.90	31.40
11	15.85	27.20	39.90	31.40
13	15.85	28.70	41.90	31.40
15	15.85	35.10	48.10	33.40
17	15.85	38.60	50.60	33.40
19	15.85	38.60	51.00	34.40
21	15.85	39.40	53.80	39.00
23	15.85	39.40	57.30	39.00
25	15.85	39.40	60.10	39.00

Receptacle type 7				
Shell size	L17 Max	L18 Max	L19 Max	L20 Max
09	13.66	24.22	37.68	29.22
11	13.66	25.22	37.68	29.22
13	13.66	26.52	39.66	29.22
15	13.66	32.92	45.83	31.22
17	13.66	36.42	48.40	31.22
19	13.66	36.42	48.81	32.22
21	13.66	36.42	50.79	36.02
23	13.66	36.42	54.34	36.02
25	13.66	36.42	57.14	36.02



Mated connectors dimensions

Type 0 with plug
(type 5)

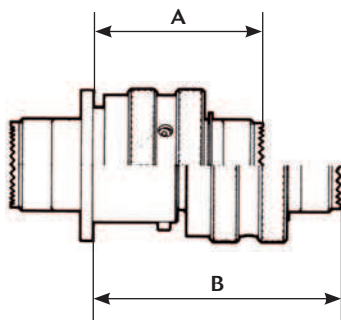

Type 7 with plug
(type 5)

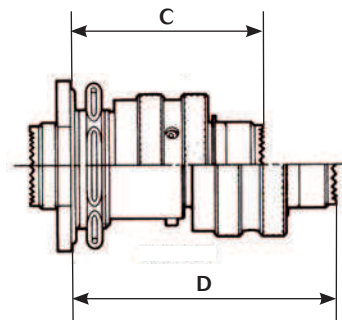

Shell Size	A Max	B Max	C Max	D Max
09	33.30	47.40	40.60	54.70
11				
13				
15				
17				
19	32.50	46.70	40.60	54.70
21				
23				
25				



Contact layouts

09

35	98
6#22D Service M	3#20 Service I

- Contact #22D
- Contact #20
- Contact #16
- Contact #12
- Contact #10
- Contact #8
- Contact #8 Power
- Contact #8 Quadrax
- Contact #4 Power

11

01	02	04	05	22*
1#12 Service II	2#16 Service I	4#20 Service I	5#20 Service I	4#22D Service M
35	80	81	98	99
13#22D Service M	1#8 triax Service I	1#8 quadrax	6#20 Service I	7#20 Service I

13

03	04	08	26	35	98
3#16 Service I	4#16 Service I	8#20 Service I	6#22D 2#12 Service M	22#22D Service M	10#20 Service I

* Available on specific request. Please consult us.

Ethernet Quadrax

8LT Series



15

05	15	18	19	35	97
5#16 Service II	14#20 1#16 Service I	18#20 Service I	19#20 Service I	37#22D Service M	8#20 4#16 Service I

17

02	06*	08	20*	22	26
38#22D 1#8 triax Service M	6#12 or 6#12 Coax Service I	8#16 Service II	16#22D 4#12 Service M	2#12 2#8 triax Service M	26#20 Service I
35	75	80	81	82	99
55#22D Service M	2#8 triax Service M	2#12 2#8 quadrax	38#22D 1#8 quadrax	2#8 quadrax	2#16 21#20 Service I

19

11	18	28	32	35	84
11#16 Service II	14#22D 4#8 triax Service M	26#20 2#16 Service I	32#20 Service I	66#22D Service M	14#22D 4#8 quadrax

* Available on specific request. Please consult us.

Ethernet Quadrax

8LT Series



21

11

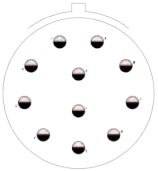

11#12

Service I

16

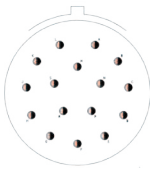

16#16

Service II

35

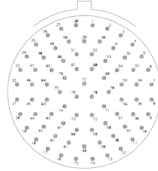

79#22D

Service M

39

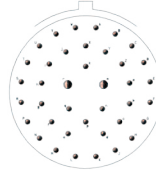

37#20
2#16
Service I

41

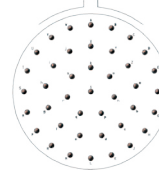

41#20
Service I

42

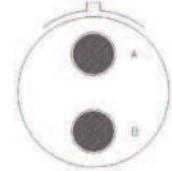

2#4 power
Service I

48

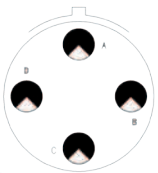

4#8 power
Service I

72



2#4 power
6#12
Service I

75

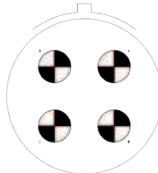

4#8 triax
Service M

78



17#22D
2#8 coax
Service M

84

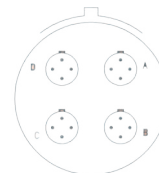

4#8 quadrax

23

21

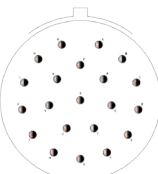

21#16
Service I

32

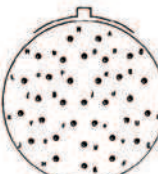

32#20
Service I

35

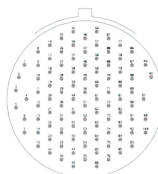

100#22D
Service M

53

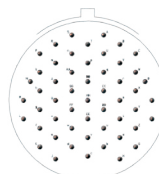

53#20
Service I

54

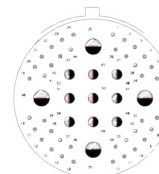

40#22D
9#16
4#12
Service M

55

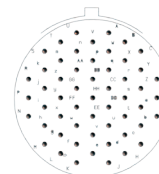

55#20
Service I

Ethernet Quadrax

8LT Series



25

<p>04</p>	<p>07</p>	<p>08*</p>	<p>11*</p>	<p>19</p>	<p>24</p>
<p>48#20 8#16 Service I</p>	<p>97#22D 2#8 triax Service M</p>	<p>8#8 triax Service M</p>	<p>2#20 9#10 Service N</p>	<p>19#12 Service I</p>	<p>12#12 12#16 Service II</p>
<p>29</p>	<p>35</p>	<p>37</p>	<p>41</p>	<p>43</p>	<p>44</p>
<p>29#16 Service I</p>	<p>128#22D Service M</p>	<p>37#16 Service I</p>	<p>22#22D 3#20 11#16 2#12 3#8 triax Service N</p>	<p>20#16 23#20 Service I</p>	<p>4#4 power 4#16 Service I</p>
<p>46</p>	<p>61</p>	<p>81</p>	<p>82</p>	<p>86</p>	<p>88*</p>
<p>40#20 4#16 2#8 coax Service I</p>	<p>61#20 Service I</p>	<p>22#22D 3#20 11#16 2#12 3#8 quadrax</p>	<p>97#22D 2#8 quadrax</p>	<p>40#20 4#16 2#8 quadrax</p>	<p>8#8 quadrax</p>
<p>90</p>					
<p>40#20 4#16 2#8 triax Service I</p>					

* Available on specific request. Please consult us.

Ethernet Quadrax



8LT Series



Contact layouts (matrix)

Shell Size	Layout	Service	8LT	8LT2	MIL - DTL - 38999 (QPL)		HE 308		Nber of Contacts	# 22D	# 20	# 16	# 12	# 10	# 8	#4 Power
					MS (1)	MS27505	Not Rack	Rack								
09 / A	09 - 35	M					O	X	6	6						
	09 - 98	I					O	X	3		3					
11 / B	11 - 01	II							*	1			1			
	11 - 02	I							*	2		2				
	11 - 04	I							*	4	4					
	11 - 05	I							*	5	5					
	11 - 22	M								4	4					
	11 - 35	M					O	X	*	13	13					
	11 - 80	I								1					1 Triax	
	11 - 81	-								1					1 Quadrax	
	11 - 98	I					O	X	*	6	6					
11 - 99	I							*	7	7						
13 / C	13 - 03	I								3		3				
	13 - 04	I					O		*	4		4				
	13 - 08	I							*	8	8					
	13 - 26	M								8	6		2			
	13 - 35	M					O	X	*	22	22					
	13 - 98	I					O	X	*	10	10					
15 / D	15 - 05	II					O	X	*	5		5				
	15 - 15	I							*	15	14	1				
	15 - 18	I					O		*	18	18					
	15 - 19	I					O	X	*	19	19					
	15 - 35	M					O	X	*	37	37					
	15 - 97	I					O	X	*	12	8	4				
17 / E	17 - 02	M								39	38				1 Triax	
	17 - 06	I					O		*	6	6					
	17 - 08	II					O	X	*	8		8				
	17 - 20	M								20	16		4			
	17 - 22	M								4			2		2 Triax	
	17 - 26	I					O	X	*	26	26					
	17 - 35	M					O	X	*	55	55					
	17 - 75	M							*	2					2 Triax	
	17 - 80	-								4			2		2 Quadrax	
	17 - 81	-								39	38				1 Quadrax	
	17 - 82	-								2					2 Quadrax	
17 - 99	I					O	X	*	23	21	2					
19 / F	19 - 11	II					O	X	*	11		11				
	19 - 18	M								18	14				4 Triax	
	19 - 28	I							*	28	26	2				
	19 - 32	I					O	X	*	32	32					
	19 - 35	M					O	X	*	66	66					
19 - 84	-								18	14				4 Quadrax		

(1) available MS27466 & MS27467 & MS27468 & MS27656

 SOLURIAL's layout
 Qualified Layout (QPL) MIL - DTL 38999

X Qualified Layout HE308 for «ministère de la défense» DGA DTAT
O Layout according to LITE C 93-422 norm
* Layout according to C5935X0005 norm

8LT Series



Contact layouts (matrix)

Shell Size	Layout	Service	8LT	8LT2	MIL - DTL - 38999 (QPL)		HE 308		Nber of Contacts	# 22D	# 20	# 16	# 12	# 10	# 8	#4 Power
					MS (1)	MS27505	Not Rack	Rack								
21 / G	21 - 11	I					O	X	*	11			11			
	21 - 16	II					O	X	*	16		16				
	21 - 35	M					O	X	*	79	79					
	21 - 39	I					O		*	39		37	2			
	21 - 41	I					O	X	*	41		41				
	21 - 42	I								2						2
	21 - 48	I								4					4 Power	
	21 - 72	I								8		6				2
	21 - 75	-							*	4					4 Triax	
	21 - 78	M								19	17				2 Coax	
21 - 84	-								4					4 Quadrax		
23 / H	23 - 21	II					O		*	21		21				
	23 - 32	I								32	32					
	23 - 35	M					O	X	*	100	100					
	23 - 53	I					O	X	*	53		53				
	23 - 54	M								53	40	9	4			
	23 - 55	I							*	55		55				
25 / J	25 - 04	I								56	48	8				
	25 - 07	M								99	97				2 Triax	
	25 - 08	-								8					8 Triax	
	25 - 11	N								11	2			9		
	25 - 19	I					O	X		19			19			
	25 - 24	II								24		12	12			
	25 - 29	I					O	X		29		29				
	25 - 35	M					O	X		128	128					
	25 - 37	I								37		37				
	25 - 41	N								41	22	3	11	2	3 Triax	
	25 - 43	I								43		23	20			
	25 - 44	I								8		4				4
	25 - 46	I								46	40	4			2 Coax	
	25 - 61	I					O	X		61		61				
	25 - 81	N								41	22	3	11	2	3 Quadrax	
	25 - 82	M								99	97				2 Quadrax	
25 - 86	I								46		40	4		2 Quadrax		
25 - 88	-								8					8 Quadrax		
25 - 90	I								46		40	4		2 Triax		

(1) available MS27466 & MS27467 & MS27468 & MS27656

	SOURIALU's layout
	Qualified Layout (QPL) MIL - DTL 38999

- X Qualified Layout HE308 for «ministère de la défense» DGA DTAT
- O Layout according to UTE C 93-422 norm
- * Layout according to C5935X0005 norm



Souriau connector part numbers

Basic series	8LT	0	-	13	B	35	P	N	***	-	L
Shell type											
0: Square flange receptacle											
1: Cable connecting receptacle											
2: Short square flange receptacle, not accepting backshell											
3: Square flange receptacle (rear mounting)											
5: Plug with RFI shielding											
7: Jam nut receptacle											
15: Plug with RFI shielding, not accepting backshell											
Type											
None: Connector with standard crimp contacts											
L: Connector with long spill (male and female #22D)											
C: Connector with short spill (male and female #22D, #20, #16, #12, #8 quadrax)											
T: Connector with male contact size 20 for wire wrap (2 wraps)											
W: Connector with male contact size 22D for wire wrap (3 wraps)											
S: Connector with specific PC Tail (male and female #22D only)											
Q: Connector with quadrax crimp contacts											
P: Connector with solder cup: . Pin: #22D & #16; Socket: #12 . Socket: #22D & #16; Pin: #12 - Please consult us											
Shell size											
09 - 11 - 13 - 15 - 17 - 19 - 21 - 23 - 25											
Plating											
F: Nickel B: Olive green cadmium Z: Green zinc cobalt L: Black zinc nickel											
Contact layout											
See tables pages 14 to 19											
Contact type											
P: Male A: Connector supplied less pin contact or with specific contacts (Connector marking : A + orientation)											
S: Female B: Connector supplied less socket contact or with specific contacts (Connector marking : B + orientation)											
Orientation (1)											
N, A, B, C, D see table page 37											
Specifications											
None: Supplied with contact											
046: PC Tail contact with tinned plating											
251: Connector provided with power contacts with layout contacts #8											
022: Fuel tank Please consult us											
*284: Quadrax grounded (cts 100Ω) (2)											
308: Quadrax not grounded (cts 100Ω) (2)											
*384: Quadrax grounded (cts 150Ω) (2)											
408: Quadrax not grounded (cts 150Ω) (2)											
Special custom											
None: Standard plastic cap											
M: Antistatic plastic cap											
L: For P or S contact type only, connector delivered without contacts, connector marking P or S (without L)											

*Excepted mixed layouts with quadrax and signal contacts. Please consult us.

(1) Orientations B & C not developed for shell size number 9.

(2) Type shell 0, 3 and 5 available only.



MIL-DTL-38999 connector part numbers

Basic series	MS	27466	T	13	B	35	P	-	-	L
Shell type										
27466: Square flange receptacle (front mounting)										
27656: Square flange receptacle (rear mounting)										
27468: Jam nut receptacle										
27467: Plug with RFI shielding										
27505: Square flange receptacle, not accepting backshell										
Class										
E: Without thread for back fitting, not accepting backshell for MS27505 and MS27467 only										
T: With thread for backfitting, supplied without backshell (excepted MS27505)										
Shell size										
09 - 11 - 13 - 15 - 17 - 19 - 21 - 23 - 25										
Plating										
F: Nickel B: Olive green cadmium										
Contact layout										
See tables pages 14 to 19										
Contact type										
P: Male A: Connector supplied less pin contact or with specific contacts (Connector marking : A + orientation)										
S: Female B: Connector supplied less socket contact or with specific contacts (Connector marking : B + orientation)										
Orientation (1)										
None: Normal (N)										
A, B, C, D see table page 37										
Special custom										
None: Standard plastic cap										
M: Antistatic plastic cap										
L: For P or S contact type only, connector delivered without contacts, connector marking P or S (without L)										

HE 308 connector part numbers

Basic series	HE308	00	T	13	35	P	N	7	M	-	L
Shell type											
00: Square flange receptacle											
07: Jam nut receptacle											
06: Plug with RFI shielding											
11: Jam nut receptacle with PC Tail contacts											
Class											
T: Sealed											
Shell size											
09 - 11 - 13 - 15 - 17 - 19 - 21 - 23 - 25											
Contact layout											
See tables pages 14 to 19											
Contact type											
P: Male											
S: Female											
Orientation (1)											
N, A, B, C, D see table page 37											
Plating											
6: Nickel											
7: Olive green cadmium											
Contractual specification											
Special custom											
None: Standard plastic cap											
M: Antistatic plastic cap											
Specification											
None: Connector supplied with contact											
L: Connector supplied without contact											

(1) Orientations B & C not developed for shell size number 9.



Dimensions

Receptacle type 0

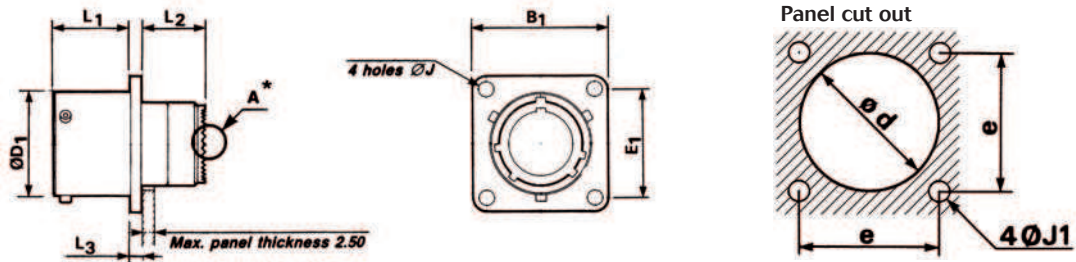

Shell size		09	11	13	15	17	19	21	23	25	
B1	Min	23.70	26.05	28.50	30.85	33.20	36.40	39.55	42.75	46.00	
	Max	24.30	26.70	29.05	31.45	33.80	37.00	40.15	43.35	46.50	
E1		18.26	20.62	23.01	24.61	26.97	29.36	31.75	34.93	38.10	
D1	Min	14.40	17.65	21.40	24.65	27.82	29.24	33.70	36.92	40.06	
	Max	14.53	17.78	21.59	24.77	27.94	30.66	33.83	37.00	40.18	
J	Min	3.25	3.25	3.25	3.25	3.25	3.25	3.25	3.73	3.73	
	Max	3.35	3.35	3.35	3.35	3.35	3.35	3.35	3.83	3.83	
L1	Min	15.93	15.93	15.93	15.93	15.93	15.93	15.17	15.17	15.17	
	Max	16.05	16.05	16.05	16.05	16.05	16.05	15.29	15.29	15.29	
L2	Min	13.23	13.23	13.23	13.23	13.23	13.23	13.23	13.23	13.23	
	Max	13.49	13.49	13.49	13.49	13.49	13.49	13.49	13.49	13.49	
L3	Min	2.14	2.14	2.14	2.14	2.14	2.14	2.90	2.90	2.90	
	Max	2.54	2.54	2.54	2.54	2.54	2.54	3.30	3.30	3.30	
d		Min	15.70	18.70	21.80	25.00	28.30	31.00	34.20	37.30	40.50
J1		± 0.15	3.25	3.25	3.25	3.25	3.25	3.25	3.91	3.91	
e		18.26	20.62	23.01	24.61	26.97	29.36	31.75	34.92	38.10	

Cable connecting receptacle type 1

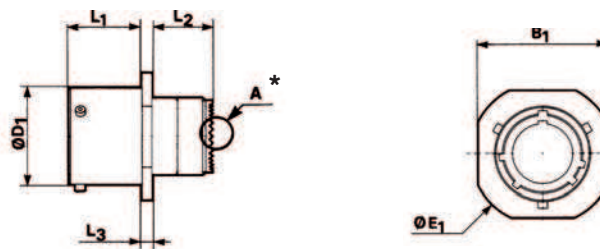

Shell size		09	11	13	15	17	19	21	23	25
B1	Min	18.35	21.65	25.05	27.25	30.78	34.05	37.45	41.45	45.93
	Max	18.92	22.22	25.62	27.82	31.35	34.62	38.02	42.02	46.50
E1	Min	21.80	25.10	28.50	30.70	34.10	37.50	40.90	44.90	49.40
	Max	22.35	25.65	29.05	31.25	34.65	38.05	41.45	45.45	49.95
D1	Min	14.40	17.65	21.40	24.65	27.82	29.24	33.70	36.92	40.06
	Max	14.53	17.78	21.59	24.77	27.94	30.66	33.83	37.00	40.18
L1	Min	15.93	15.93	15.93	15.93	15.93	15.93	15.17	15.17	15.17
	Max	16.05	16.05	16.05	16.05	16.05	16.05	15.29	15.29	15.29
L2	Min	13.23	13.23	13.23	13.23	13.23	13.23	13.23	13.23	13.23
	Max	13.45	13.45	13.45	13.45	13.45	13.45	13.45	13.45	13.45
L3	Min	2.14	2.14	2.14	2.14	2.14	2.14	2.90	2.90	2.90
	Max	2.54	2.54	2.54	2.54	2.54	2.54	3.30	3.30	3.30



Receptacle type 3

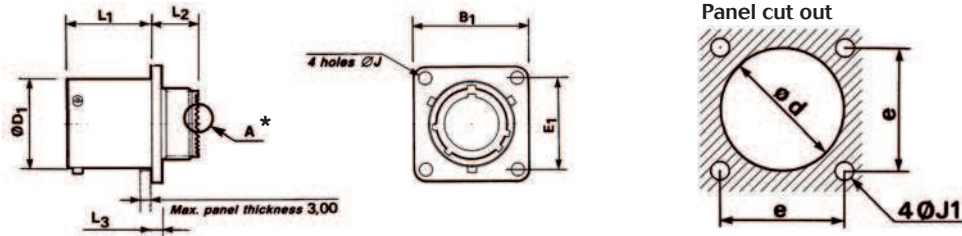

Shell size		09	11	13	15	17	19	21	23	25
B1	Min	23.70	26.05	28.50	30.85	33.20	36.40	39.55	42.75	46.00
	Max	24.30	26.70	29.05	31.45	33.80	37.00	40.15	43.35	46.50
E1		18.26	20.62	23.01	24.61	26.97	29.36	31.75	34.93	38.10
D1	Min	14.40	17.65	21.40	24.65	27.82	29.24	33.70	36.92	40.06
	Max	14.53	17.78	21.59	24.77	27.94	30.66	33.83	37.00	40.18
J	Min	3.25	3.25	3.25	3.25	3.25	3.25	3.25	3.73	3.73
	Max	3.35	3.35	3.35	3.35	3.35	3.35	3.35	3.83	3.83
L1	Min	20.71	20.71	20.71	20.71	20.71	20.71	19.96	19.96	19.96
	Max	20.83	20.83	20.83	20.83	20.83	20.83	20.08	20.08	20.08
L2	Min	10.40	10.40	10.40	10.40	10.40	10.40	11.15	11.15	11.15
	Max	11.90	11.90	11.90	11.90	11.90	11.90	12.70	12.70	12.70
L3	Min	2.14	2.14	2.14	2.14	2.14	2.14	2.90	2.90	2.90
	Max	2.54	2.54	2.54	2.54	2.54	2.54	3.30	3.30	3.30
d	Min	16.66	20.22	23.42	26.59	30.96	32.94	36.12	39.29	42.47
J1	± 0.15	3.25	3.25	3.25	3.25	3.25	3.25	3.25	3.91	3.91
e		18.26	20.62	23.01	24.61	26.97	29.36	31.75	34.92	38.10

Receptacle type 7 & HE 308 type 11

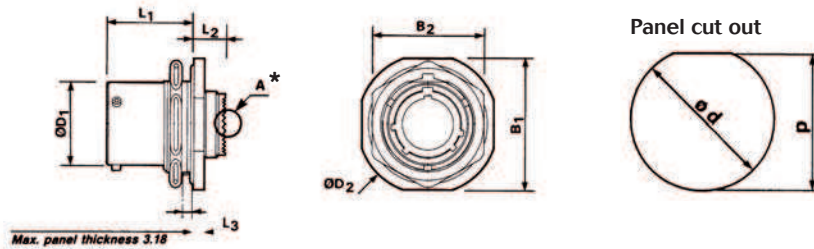

Shell size		09	11	13	15	17	19	21	23	25
B1	Min	26.60	31.40	34.60	37.80	40.90	45.63	48.84	52.02	55.19
	Max	27.35	32.10	35.31	38.49	41.63	46.37	49.58	52.76	55.93
B2	Min	21.95	25.15	29.80	33.05	36.25	39.40	42.60	45.75	50.65
	Max	22.35	25.55	30.30	33.45	36.65	39.80	43.00	46.15	50.95
D1	Min	14.40	17.65	21.40	24.65	27.82	29.24	33.70	36.92	40.06
	Max	14.53	17.78	21.59	24.77	27.94	30.66	33.83	37.00	40.18
D2	Min	29.90	34.60	37.75	41.00	44.11	48.90	52.00	55.30	58.40
	Max	30.58	35.30	38.50	41.65	44.85	49.60	52.75	55.94	59.10
L1	Min	23.12	23.12	23.12	23.12	23.12	23.12	23.12	23.12	23.12
	Max	23.36	23.36	23.36	23.36	23.36	23.36	23.36	23.36	23.36
L2	Min	8.18	8.18	8.18	8.18	8.18	8.18	8.18	8.18	8.18
	Max	8.32	8.32	8.32	8.32	8.32	8.32	8.32	8.32	8.32
L3	Min	2.60	2.60	2.60	2.60	2.60	3.35	3.35	3.35	3.35
	Max	3.00	3.00	3.00	3.00	3.00	3.79	3.79	3.79	3.79
d	0/-0.25	17.78	20.96	25.65	28.83	32.00	35.18	38.35	41.53	44.70
p	0/-0.25	17.02	18.58	24.26	27.56	30.73	33.91	37.08	40.26	43.45



Square flange receptacle type 2

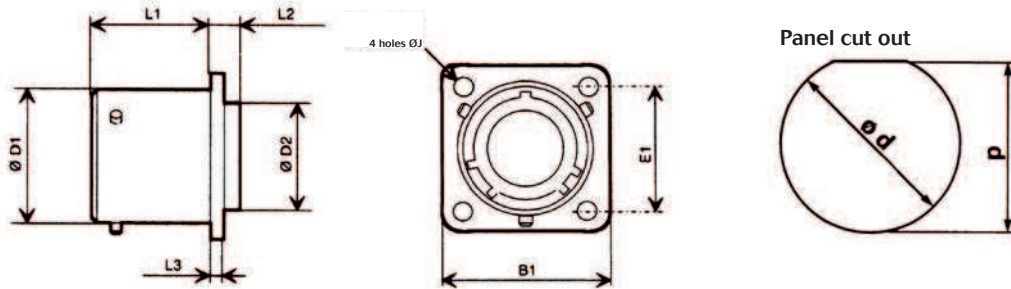

Shell size		09	11	13	15	17	19	21	23	25
B1	Min	23.70	26.05	28.50	30.85	33.20	36.40	39.55	42.75	46.00
	Max	24.30	26.70	29.05	31.45	33.80	37.00	40.15	43.35	46.50
E1		18.26	20.62	23.01	24.61	26.97	29.36	31.75	34.93	38.10
D1	Min	14.40	17.65	21.40	24.65	27.82	29.24	33.70	36.92	40.06
	Max	14.53	17.78	21.59	24.77	27.94	30.66	33.83	37.00	40.18
D2	Min	9.85	12.80	16.00	18.95	22.10	25.10	28.25	31.40	34.60
	Max	9.95	12.90	16.10	19.05	22.20	25.20	28.35	31.50	34.70
J	Min	3.25	3.25	3.25	3.25	3.25	3.25	3.25	3.73	3.73
	Max	3.35	3.35	3.35	3.35	3.35	3.35	3.35	3.83	3.83
L1	Min	20.71	20.71	20.71	20.71	20.71	20.71	19.96	19.96	19.96
	Max	20.83	20.83	20.83	20.83	20.83	20.83	20.08	20.08	20.08
L2	Min	5.40	5.40	5.40	5.40	5.40	5.40	6.15	6.15	6.15
	Max	5.55	5.55	5.55	5.55	5.55	5.55	6.35	6.35	6.35
L3	Min	2.14	2.14	2.14	2.14	2.14	2.14	2.90	2.90	2.90
	Max	2.54	2.54	2.54	2.54	2.54	2.54	3.30	3.30	3.30
d	Min	16.66	20.22	23.42	26.59	30.96	32.94	36.12	39.29	42.47
J1	± 0.15	3.25	3.25	3.25	3.25	3.25	3.25	3.25	3.91	3.91
e		18.26	20.62	23.01	24.61	26.97	29.36	31.75	34.92	38.10

Plug type 5 & type 15

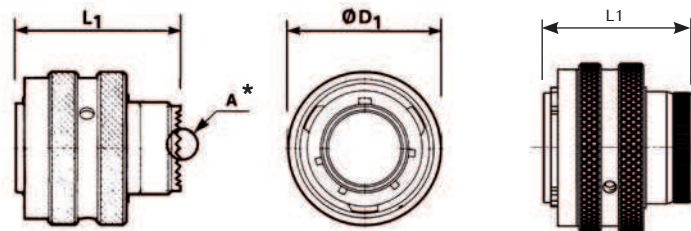

Type 5

Type 5 and 15

Type 15

Shell size		09	11	13	15	17	19	21	23	25
D1	Min	14.35	17.70	21.50	24.65	27.85	30.55	33.75	36.90	40.10
	Max	21.80	25.00	29.30	32.50	35.70	38.50	41.70	43.85	48.00
L1	Min	31.28	31.28	31.28	31.28	31.28	31.28	31.28	31.28	31.28
	Max	31.35	31.35	31.35	31.35	31.35	31.35	31.35	31.35	31.35

* Detail A see page 27



Receptacle with PC Tail contact

Receptacle type 7

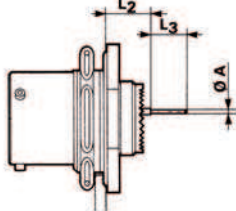

Receptacle type 0

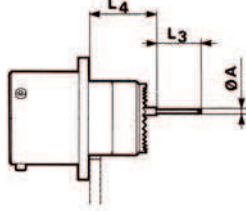

Receptacle type 3

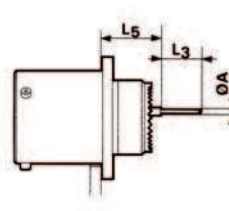

Receptacle type 2

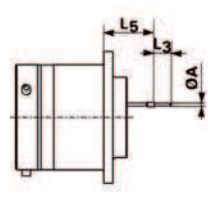

Shell Size																
	Contact Size	Contact Type *	Spill Contact **	09	11	13	15	17	19	21	23	25				
Ø A	#22D	M & F	C & L									0.70				
			S									0.50				
	#20	M & F	M									0.50				
			C									0.70				
			C									1.15				
L3	#22D	M & F	C									4 ⁰ _{-0.20}				
			S									5 ^{±0.1}				
			L									8.5 ⁰ _{-0.20}				
	#20	M & F	M									6 ^{±0.1}				
			C									5 ^{±0.1}				
#16	M & F	C									5 ^{±0.1}					
L2 type 7	8LT #22D	M	C & L	Max									10.06			
			Min									9.07				
		M	M	Max									10.21			
			Min									9.23				
	F	C & L	Max									10.06				
			Min									8.74				
		M	S	Max									10.23			
			Min									9.24				
	8LT7S HE308 #22D	M	S	Max									10.23			
				Min									9.24			
		F	S	Max									10.23			
				Min									8.91			
8LT HE308 #20 & #16	M & F	C	Max									10.23				
			Min									9.24				
	#22D	M	C & L	Max									15.08			
				Min									13.91			
M		M	Max									15.22				
			Min									14.05				
F	C & L	Max									15.08					
		Min									13.58					
	M	S	Max	15.25									-			
			Min	14.08									-			
F	S	Max	15.25									-				
		Min	13.75									-				
#20 & #16	M & F	C	Max									15.25				
			Min									14.08				
L5 type 2 type 3	#22D	M	C & L	Max							12.47		13.22			
				Min							11.60		12.35			
		F	C & L	Max							12.47		13.22			
				Min							11.27		12.02			
	M	S	Max	12.64							-		12.64		13.39	
			Min	11.77							-		11.77		12.52	
	F	S	Max	12.64							-		12.64		13.39	
			Min	11.44							-		11.44		12.19	
	#20 & #16	M & F	C	Max							12.64		13.39			
				Min							11.77		12.52			

* M: Male Contact, F: Female Contact

** C: Short Spill, M: Medium Spill, L: Long Spill, S: Specific Spill



Receptacle type 7 with wire wrap contacts

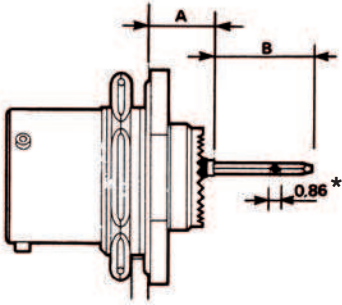

Contact size	Contact type	A	B Max
#22D	W 3 wraps	9.07 to 10.06	16.00
#20	T 2 wraps	9.7 to 10.06	12.60

* See page 35

Detail A

sealing bushing used for triaxial # 8 protude

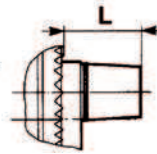

Shell Type	Type 0	Type 1	Type 3	Type 5	Type 7
L max	13.39	13.58	13.58	13.54	13.58



Rack and Panel

Souriau Rack and Panel connectors part numbers

Basic series	8 LT	27	-	15	B	35	P	N	-	-	L
Shell type											
27: Receptacle for rack, for male contacts, with possibility to mount rear accessory											
23: Square flange receptacle (consult us)											
26: Floating plug for rack, for crimp female contacts, with possibility to mount rear accessory											
Type											
None: Connector with standard crimp contacts											
Q: Connector with quadrax crimp contacts											
C: Connector with short spill (male and female #20, #16, #12, #8 quadrax)											
S: Connector with specific PC Tail (male and female #22D only)											
L: Connector with long spill (male and female #22D)											
Shell size: 11, 13, 15, 17, 19, 21, 23, 25											
Plating											
F: Nickel B: Olive green cadmium											
Contact layout: See tables pages 14 to 19											
Contact type											
P: Male S: Female											
Polarization: N											
Specification											
None: Supplied with contacts											
251: Connector provided with power contacts (for layout with cavities #8)											
*284: Quadrax grounded (cts 100Ω)											
308: Quadrax not grounded (cts 100Ω)											
*384: Quadrax grounded (cts 150Ω)											
408: Quadrax not grounded (cts 150Ω)											
Special custom											
None: Standard plastic cap M: Antistatic plastic cap											
L: Connector supplied without contacts											

*Excepted mixed layouts with quadrax and signal contacts. Please consult us.

HE 308 Rack and Panel connectors part numbers

Basic series	HE308	26	T	23	01	P	N	7	M	-	-
Shell type											
26: Floating plug for rack, for crimp female contacts, with possibility to mount rear accessory											
27: Receptacle for rack, for male contacts, with possibility to mount rear accessory											
21: Receptacle for rack with PC Tail contacts											
Class											
T: Sealed											
Shell size: 11, 13, 15, 17, 19, 21, 23											
Contact layout: See tables pages 14 to 19											
Contact type											
P: Male S: Female											
Polarization: N											
Plating											
7: Olive green cadmium											
Contractual specifications											
M: DAT quality insurance											
Special custom											
None: Standard plastic cap M: Antistatic plastic cap											
Specifications											
None: Connector supplied with contact L: Connector supplied without contact											



Rack and Panel

Features & benefits

- Signal and Power connector
- Easy and fast connection without any coupling/uncoupling between a float-mounting unit and a fixed unit.
- 100% scoop proof
- Plug misalignment allowed
- Rear accessories available
- 8 shell sizes available: from 11 to 23 with DTAT-C5935-X0005 layout - including power contact cavities
- Sealing as per HE 308
- EMI performances as per DTAT-C5935-X0005

Shell Size	Mated Force (daN)	Unmated Force (daN)
11	20	12
13	30	13
15	35	15
17	50	16
19	55	18
21	65	22
23	80	27
25 *	-	-

* Please consult us

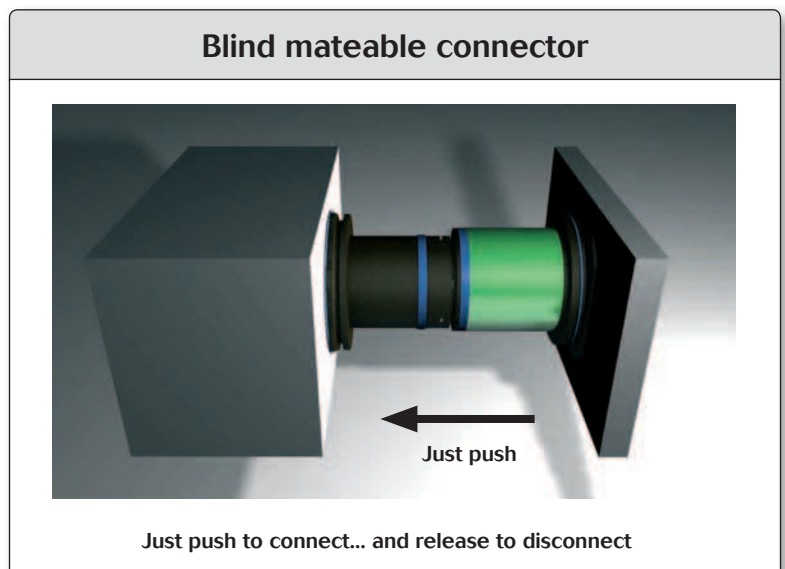

Superior misalignment allowances

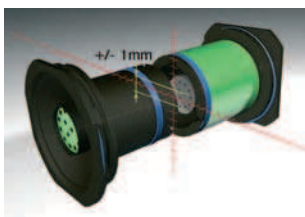

Axial alignment

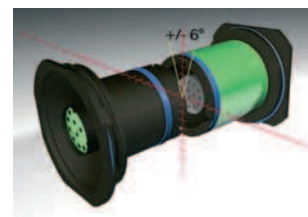
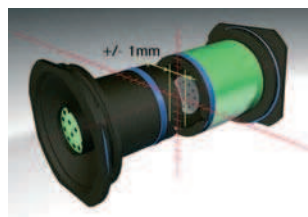

Angular alignment

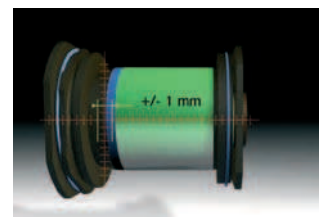

Longitudinal alignment



Rack and Panel

Dimensions

Equipment receptacle (type 27)

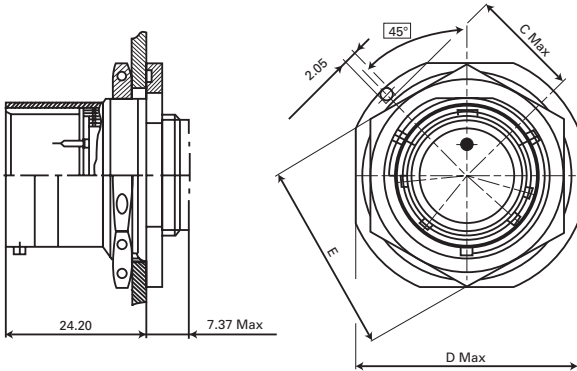

Shells	11	13	15	17	19	21	23	25
C Max	15.33	16.92	18.51	20.10	22.67	24.26	25.84	27.43
D Max	32.16	35.34	38.51	41.69	46.43	49.64	52.78	56.00
E	25.55	30.30	33.45	36.65	39.80	43	46.15	50.95

Rack plug (type 26)

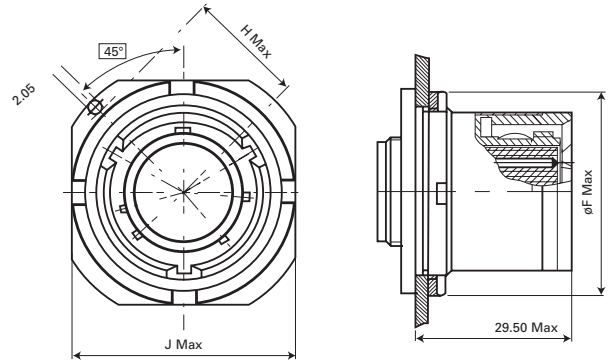

Shells	11	13	15	17	19	21	23	25
ØF Max	32.10	35.25	38.40	41.60	46.30	49.60	52.70	55.90
H Max	16.92	18.51	20.10	22.67	24.26	25.84	27.43	29.03
J Max	32.16	35.34	38.51	41.69	46.43	49.64	52.78	55.96

Square flange receptacle (type 23)

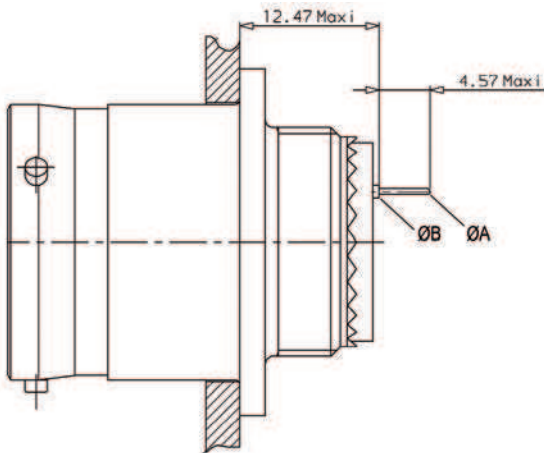

Contact size	#22D	#20	#16
A	0.5	0.7	1.15
B	1	1.5	2.2

Mated connectors

plug (type 26) and receptacle (type 27)

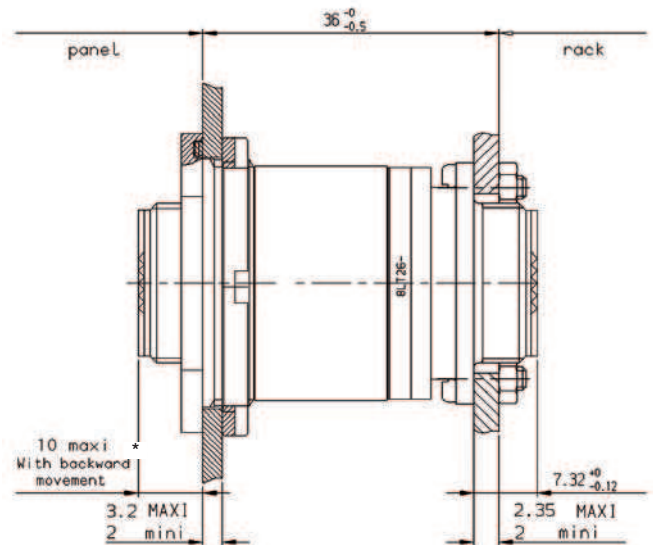

*Included longitudinal alignment



Rack and Panel

Panel cut out

Plug panel cut

Shell size	Plug			Ø 2 ^{0-0.05}
	W	Ø X ^{+0.1/0}	K mini	
11	12.81	25.58	32.57	
13	13.94	28.80	36	
15	15.06	31.98	39.60	
17	16.88	35.15	43.30	
19	18	38.28	47	
21	19.12	41.50	50.60	
23	20.24	44.68	54.20	
25	21.38	47.85	57.45	

Receptacle panel cut









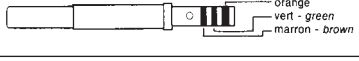

Shell size	Plug			Ø 2 ^{0-0.05}
	W	Ø X ^{+0.1/0}	K mini	
09	10	17.70	27.80	
11	11.69	20.86	32.57	
13	12.81	25.58	36	
15	13.94	28.80	39.60	
17	15.06	31.98	43.30	
19	16.88	35.15	47	
21	18	38.28	50.60	
23	19.12	41.50	54.20	
25	20.24	44.68	59.70	

8LT Series

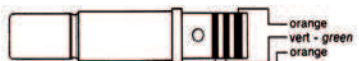

Contacts

Crimp contacts

Contact size	Contact type	SOURIAU P / N (No color code)	Contacts	
			QPL Part Numbers	Profile and color code
#22D	Pin	8599-0702 JJ	M39029/58 360	
	Socket	8599-0706 900	M39029/56 348	
#20	Pin	8599-0703 SA	M39029/58 363	
	Socket	8599-0707 900	M39029/56 351	
#16	Pin	8599-0704 MJ	M39029/58 364	
	Socket	8599-0708 900	M3929/56 352	
#16 Coaxial	Pin	N/A	M39029/76-424	-
	Socket	N/A	M39029/77-428	-
#12	Pin	8599-0705 MJ	M39029/58 365	
	Socket	8599-0709 900	M39029/56 353	
#8 Power*	Pin	8599-7580	N/A	-
	Socket	8599-7581	N/A	-
#8 Coaxial	Pin	N/A	M39029/60 367	
	Socket	N/A	M39029/59 366	-
#8 Triaxial	Pin	N/A	M39029/90 529	
		8599-5210 900 included boot 85904571	N/A	
	Socket	N/A	M39029/91 530	
		8599-5220 900 included boot 85904571	N/A	
#4 Power*	Pin	8599-7598 900**	N/A	For cable 25 mm ²
	Socket	8599-7599 900**	N/A	
	Pin	8599-7534	N/A	For cable 21,15 mm ²
	Socket	8599-7535	N/A	
#4 Power with reduced barrel	Pin	8599-7528 900	N/A	For cable #6
	Socket	8599-7529 900	N/A	

* Boots & reducers see page 34.

** Not included in connector P / N. Must be ordered separately.



Crimp contacts Technical characteristics

Contact size	Contact type	Contact \varnothing	Admissible wire section				External \varnothing over insulation mm	
			AWG		mm ²			
			min	max	min	max		
#22D	Pin	0.76	28	22	0.095	0.34	0.76	1.37
	Socket							
#20	Pin	1	24	20	0.21	0.60	1.02	2.11
	Socket							
#16	Pin	1.60	20	16	0.60	1.34	1.65	2.77
	Socket							
#16 Coaxial	Pin	1.60	RG 174 RG 179 RG 316				1.65	2.60
	Socket							
#12	Pin	2.40	14	12	1.91	3.18	2.46	3.61
	Socket							
#8 Power*	Pin	3.64		8		8.98	4.50	6.50
	Socket							
	Boot							
#8 Coaxial	Pin	3.64	RG 180 A/U					2.80
	Socket							
#8 Triaxial	Pin	5.5	MIL C 17/176.00002 FILECA F 2703/14 RAYCHEM CHEMINAX 106 12 FILOTEX M 17/176.00002				3.15	3.40
	Socket							
#4 Power*	Pin: 8599-7598 900	5.74	-	3	-	25	-	-
	Socket: 8599-7599 900							
	Pin: 8599-7534		5	4	16	21.15	-	-
	Socket: 8599-7535							
#4 Power with reduced barrel	Pin	5.74	-	6	-	13.3	-	-
	Socket							

* Boots & reductors see page 34.

8LT Series



Reducers

Reducer Size	Part number	For cable	For contacts
#8 Power	8599-7645	#10	8599-7580 (Pin) 8599-7581 (Socket)
#4 Power	8400-2352A	10 mm ²	8599-7534A (Pin) 8599-7535A (Socket)

Boots

Boot Size	Part number	Admissible wire section mm ²		For cable
#8 Power	8599-4542	5	6.5	8.48 à 10 mm ²
	8599-4547	2.5	4	#10
#4 Power	8599-4594	6.35	7.5	#4 - #5
	8599-4593	4	5.8	#6 - #8



PC tail contacts

Contact size	Contact type	Spill Type	Part Numbers	Profile
#22D 8LT	Male	L	8599-0720 900	
	Male	C	8599-0730 900	
	Female	L	8599-0721 900	
	Female	C	8599-0731 900	
	Male	M	8599-8028 900	-
#22D HE 308	Male	S	8599-0796 900	
	Female	S	8599-0797 900	
#20	Male	C	8599-0724 900	
	Female	C	8599-0725 900	
#16	Male	C	8599-0726 900	
	Female	C	8599-0727 900	
#12	Male	C	8599-7929 900	-
	Female	C	8599-7932 900	-

8LT Series



Wire wrap contacts

Contact size	Contact type	Part Numbers	Profile	Contact \varnothing mm	
#22D	Male	8599.0790 JJ		0.76	0.86
#20	Male	8599.0791 900		1	0.86

Solder cup

Contact size	Contact type	Part Numbers
#22D	Pin	8599-0750 900
#16	Pin	8599-7482A 900
#12	Socket	8599-7485A 900

For other solder cup, please consult us

Quadrax #8 contacts

Part Number	Version	Contact type	Impedance
ETH1-1235A	Crimp	Pin	100 Ω
ETH1-1503A	Crimp	Pin	150 Ω
ETH1-1236A	Crimp	Socket	100 Ω
ETH1-1504A			150 Ω
ETH1-1237A	PCB mount	Pin	100 Ω
ETH1-1501A			150 Ω
ETH1-1238A	PCB mount	Socket	100 Ω
ETH1-1502A			150 Ω

8LT Series



Thermocouple contacts

Contact size Contact type	Contact type	Souriau part numbers	Contacts MIL DTL 38999	
			Part Numbers	Profile and color code
#22D Chromel	Male Pin	N / A	M39029/87-472	
	Female Socket	N / A	M39029/88-484	
#22D Alumel	Male Pin	N / A	M39029/87-471	
	Female Socket	N / A	M39029/88-483	
#20 Chromel	Male	8599-0749 900	8599-0949 900	
	Female	8599-0753 900	8599-0953 900	
#20 Alumel	Male	8599-0761 900	8599-0961 900	
	Female	8599-0765 900	8599-0965 900	

Technical characteristics

Contact size	Contact Ø (mm)	Wire section				Ø over insulation (mm)	
		AWG		mm ²		Min	Max
		Min	Max	Min	Max		
#22D Chromel Alumel	0.76	28	22	0.095	0.34	0.76	1.37
#20 Chromel Alumel	1	24	20	0.21	0.6	1.02	2.11



Orientations

Polarization is determined by the master keyway position.
The secondary keyway positions remain fixed.

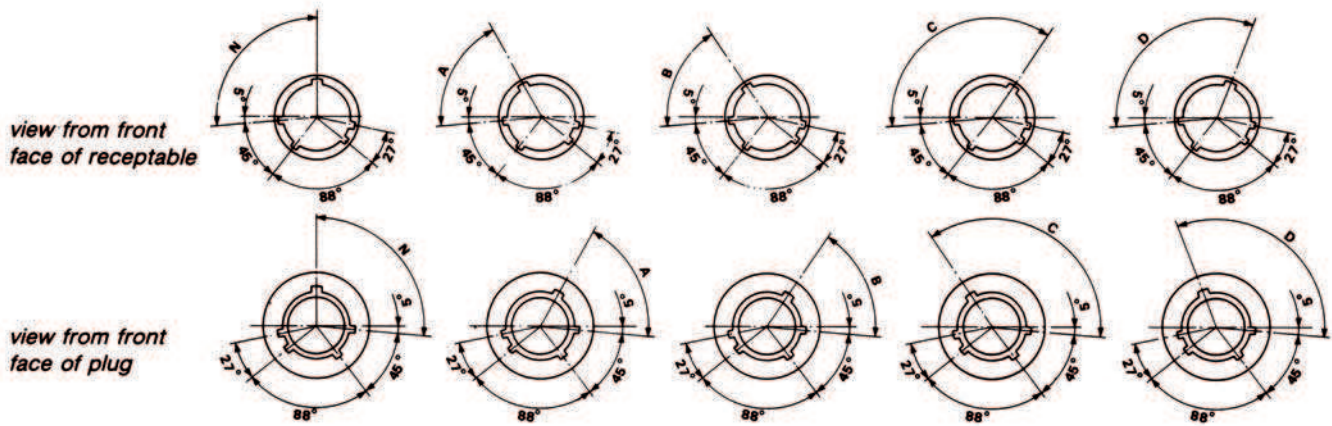

Shell size	Angles (degrees)				
	N	A	B	C	D
09	95	77	-	-	113
11	95	81	67	123	109
13	95	75	63	127	115
15	95	74	61	129	116
17	95	77	65	125	113
19	95	77	65	125	113
21	95	77	65	125	113
23	95	80	69	121	110
25	95	80	69	121	110



Accessories

Protective cap for receptacles

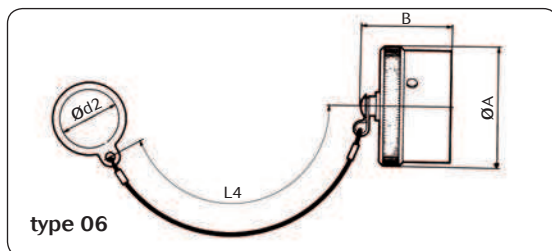
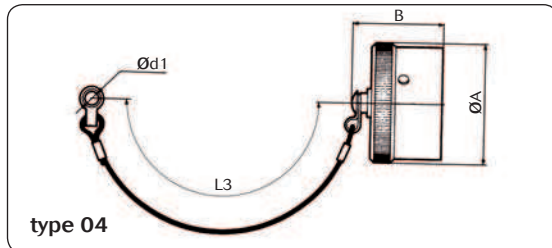
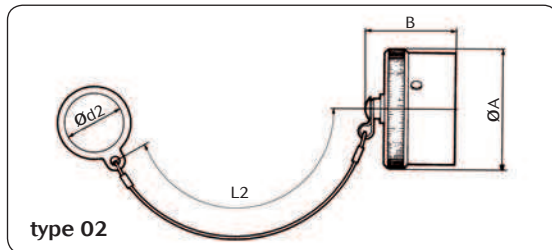
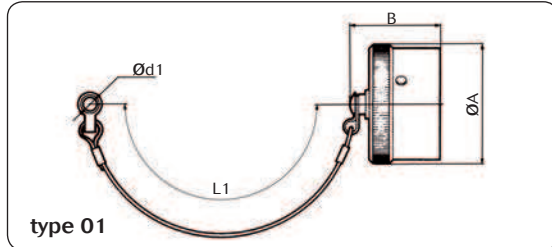

Protective cap for plugs

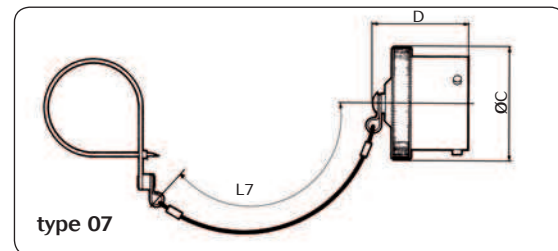
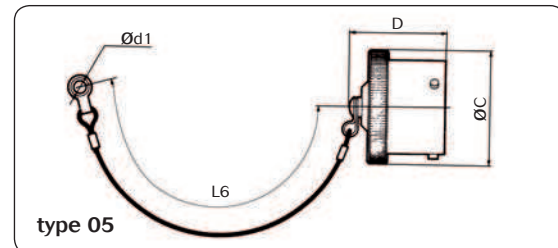
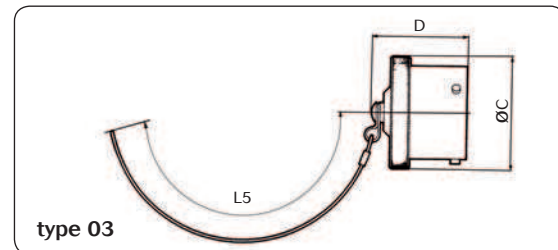
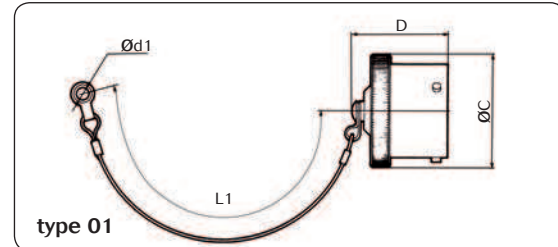

Shell size	A Max	B Max	C Max	D Max	d1 min	d2 min	L1	L2	L3±5	L4±5	L5±5	L6±5	L7±5
09	21.80	28.00	20.80	29.50	3.20	17.80	76	76	105	105	200	160	160
11	24.90	28.00	23.80	29.50	3.20	21.30	76	76	105	105	200	160	160
13	29.40	28.00	27.70	29.50	3.20	25.70	89	89	105	105	200	160	160
15	32.50	28.00	30.20	29.50	3.20	29.00	89	89	105	105	200	160	160
17	35.80	28.00	33.50	29.50	3.20	32.00	89	89	105	105	200	160	160
19	38.60	28.00	36.50	29.50	3.20	35.30	89	89	105	105	200	160	160
21	41.90	28.00	39.80	29.50	3.20	38.40	102	102	105	105	200	160	160
23	44.90	28.00	42.90	29.50	3.20	41.70	102	102	105	105	200	160	160
25	48.00	28.00	46.20	29.50	3.20	44.70	102	102	105	105	200	160	160

8LT Series



Protective caps

Basic series	8LT	E	01	B	13
Cap type					
E: Cap for receptacle					
F: Cap for plug					
Fixing type					
Cap for receptacle			Cap for plug		
01: Plastic sleeved metal card with eyelet			01: Plastic sleeved metal card with eyelet		
02: Plastic sleeved metal card with ring			03: Nylon cord without fastener		
04: Nylon cord with eyelet			05: Nylon cord with eyelet		
06: Nylon cord with ring			07: Nylon cord with strap		
10: Black nylon cord with eyelet					
Plating					
B: Olive green cadmium					
F: Nickel					
Shell size: 09 - 11 - 13 - 15 - 17 - 19 - 21 - 23 - 25					

Plastic protective caps

Shell size	Part numbers for standard cap	
	Caps for receptacle	Caps for plug
09	8500-5594	70609
11	MS90376-12R	MS90376-16Y
13	8500-5588A	8500-5600
15	8500-5589A	8500-5601
17	MS90376-20YF	8500-5602
19	8500-5601	8500-5592A
21	8500-5602	8500-5593A
23	MS90376-24R	MS90376-24R
25	8500-5593A	J599ABC6009A00

Shell size	Part numbers for antistatic cap	
	Caps for receptacle	Caps for plug
09	MS90376-10RF	MS90376-14RF
11	MS90376-12RF	MS90376-16RF
13	8500-5588N	8500-5600N
15	MS90376-18YF	8500-5601N
17	MS90376-20YF	8500-5602N
19	8500-5601N	8500-5592N
21	8500-5602N	8500-5593N
23	MS90376-24RF	-
25	8500-5593N	-

Dummy receptacle

Shell size	Part numbers	L1 Max	L3 Max	D1 Max	B1 Max	E1	J
09	8LT0-09GUR	16.05	2.54	14.53	24.25	18.26	3.25
	8LT0-09FUR						
11	8LT0-11GUR	16.05	2.54	17.78	26.60	20.62	3.25
	8LT0-11FUR						
13	8LT0-13GUR	16.05	2.54	21.59	29.00	23.01	3.25
	8LT0-13FUR						
15	8LT0615GUR	16.05	2.54	24.77	31.35	24.61	3.25
	8LT0615FUR						
17	8LT0-17GUR	16.05	2.54	27.94	33.75	26.97	3.25
	8LT0-17FUR						
19	8LT0-19GUR	16.05	2.54	30.66	36.90	29.36	3.25
	8LT0-19FUR						
21	8LT0-21GUR	15.29	3.30	33.83	40.10	31.75	3.25
	8LT0-21FUR						
23	8LT0-23GUR	15.29	3.30	37.00	43.25	34.93	3.73
	8LT0-23FUR						
25	8LT0-25GUR	15.29	3.30	40.18	46.50	38.10	3.73
	8LT0-25FUR						

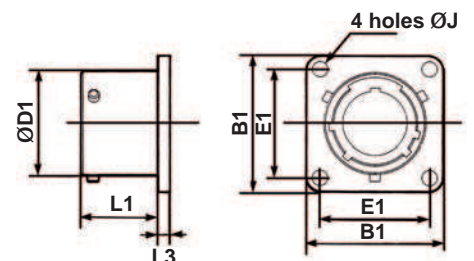

8LT Series



Panel gasket

Shell size	Part numbers	
	Gasket for receptacle type 0, 2, 3 (to be ordered separately)	O ring for receptacle type 7 (shipped with connector)
09	8599-5541	AS3582-019
11	8599-5542	AS3582-022
13	8599-5543	AS3582-024
15	8599-5544	AS3582-026
17	8599-5545	AS3582-028
19	8599-5546	AS3582-128
21	8599-5547	AS3582-130
23	8599-5548	AS3582-132
25	8599-5549	AS3582-134

Tooling

Crimping (#22D, #20, #16 and #12)

Contact size	Wire sizes		Type	Pliers						
				M22520/1-01 (Souriau 8365)		M22520/2-01 (Souriau 8476-01)		M300 BT Locator P / N	M21520/23-01	
				P / N turret		P / N locator			P / N turret	P / N locator
mm ²	AWG	Norm/Spec	Souriau	Norm/Spec	Souriau					
#22D	0.38	22	M	-	-	M22520/2-09	8476-09	-	-	-
	0.21	24	F	-	-	M22520/2-07	8476-07	-	-	-
0.15	26	-		-	-	-	-	-	-	
#20	0.095	28	M	M22520/1-04	8365-04	M22520/2-10	8476-10	-	-	-
	0.60	20	F	M22520/1-04	8365-04	M22520/2-10	8476-10	-	-	-
#16	0.38	22	M	M22520/1-04	8365-04	-	-	-	-	-
	0.21	24	F	M22520/1-04	8365-04	-	-	-	-	-
#12	1.34	16	M	M22520/1-04	8365-04	-	-	-	-	-
	0.93	18	F	M22520/1-04	8365-04	-	-	-	-	-
#8 power	0.60	20	M	-	-	-	-	SP 593	M22520/23-02	8599-9601
	1.91	14	F	-	-	-	-			
#4 power*	8.98 max	8 max	M	-	-	-	-	-	M22520/23-04	M22520/23-11
	10	7	F	-	-	-	-	-		

* Pneumatic pliers

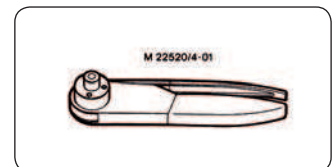
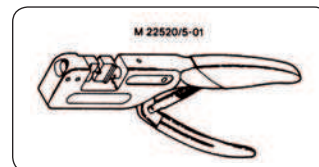
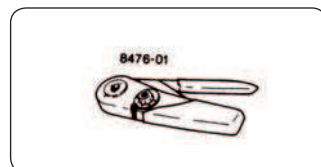
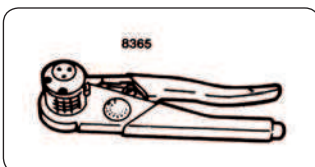

8LT Series



Coaxial contact #16

Contat type	Pliers	Locators
Inner contact	M22520/2-01	M22520/2-35
Outer contact	M22520/4-01	M22520/4-02

Triaxial contact #8

Contat type	Pliers	Locators
Middle contact	M22520/5-01	Y 631 closure B
Inner contact	M22520/2-01	K 709
Ferrule	M22520/5-01	Y 631 closure A

Quadrax contact #8

Outer body: M2252015-01 crimping tool and M2252015-45 dieset rep B
 Signal contact: M22520/201 crimping tool and K709 positioner

Dummy contact #8

Part number
8599-0308

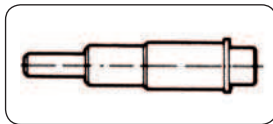

Dummy contact #4

Part number
8599-0310

Filler plugs

Contact size	Part Numbers		Color
	Spec	Souriau	
#22D	MS27488-22	8660-212	Black
#20	MS27488-20	8522-389A	Red
#16	MS27488-16	8522-390A	Blue
#12	MS27488-12	8522-391A	Yellow

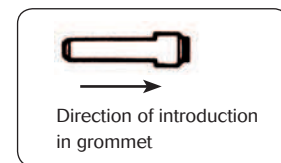

Insertion and extraction of wired contacts

Contact size	Material	Part Numbers		Color	
		Spec	Souriau	Insertion	Extraction
#22D	Plastic	M81969/14-01	8599-0022	Green	White
#20	Pastic	M81969/14-10	8522-20	Red	Orange
#16	Plastic	M81969/14-03	8522-16	Blue	White
#12	Plastic	M81969/14-04	8522-12	Yellow	White
#10	Plastic	M81969/14-05	-	Grey	White
#8	Metallic	-	8660-197	manual insertion	No colour
	Plastic	M81969/14-12	-		Red
#4	Metallic	-	8533-8175	-	No colour
	Plastic	M81969/14-07	-		Blue

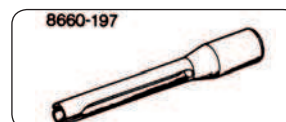
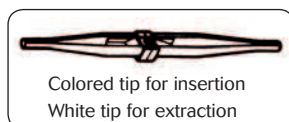



Wiring instructions

Cable preparation and wire stripping

Contact size	L (mm)	
#22D	4	
#20	6	
#16		
#12		
#8	12	
#4		

Insertion of wire in contact barrel

When inserting the stripped wire into the contact barrel check that no strands are left outside and that the wire is visible through the wire inspection hole in the barrel.

Important :

- Slide any accessories over wire strands before carrying out the following operations.
- Contacts are inserted and extracted from the rear of the connector.

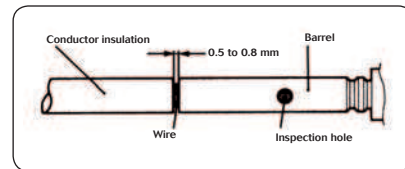

Insertion of the contacts

1 - Engage the crimp cable / contact assembly into the longitudinal slot of the plastic tool (coloured tip).
Slide the tool down the cable until the tip of the tool abuts the contact retention shoulder.

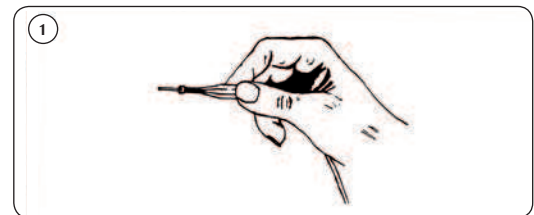

2 - Introduce the contact into the required contact cavity in the insulator, pushing tool axially, until the contact snaps into position in clip.

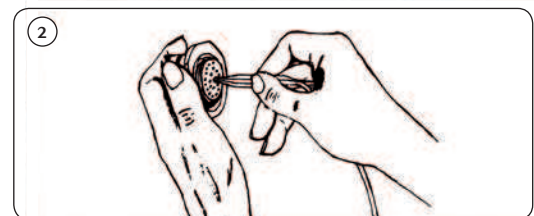

3 - Withdraw the tool (from rear). Check that contact is firmly locked by pulling wire gently.
When connector is fully loaded, check the position of contact tips. They should all be in the same plane.

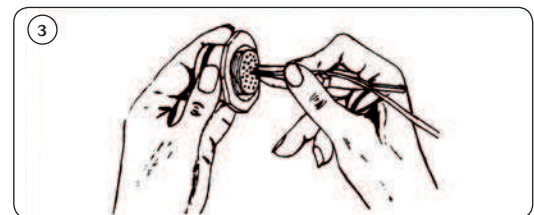

Nota : For larger sizes of cable which are stiff enough manual insertion without tool is preferable.

8LT Series



Extraction of the contacts

1 - Engage the appropriate cable into the longitudinal slot of the tool with the white tip towards connector.

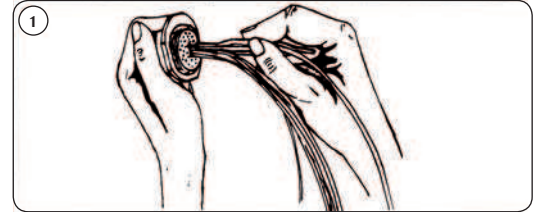

2 - Slide the tool down towards the contact. Insert the tool in the insulator until it abuts the contact shoulder.

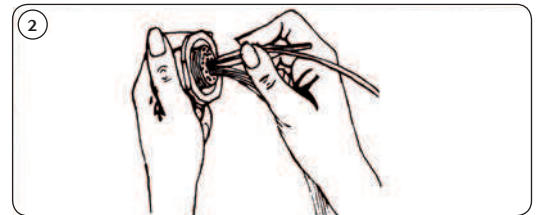

3 - Holding the tool-contact and cable assembly together, remove them simultaneously.

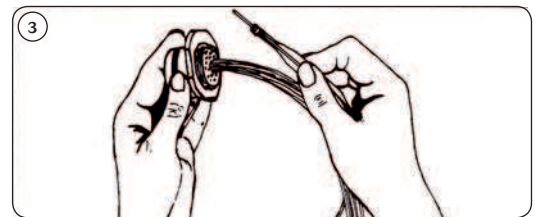

Tightening support

Part number
8599-0801

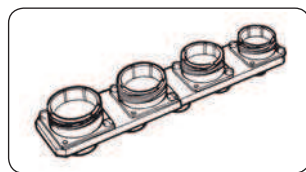

Backshell tightening and slackening tools

Backshell tightening pliers, part number : 8498-03

Square jaws, part number : 8500-1015 (order 2 jaws)

Strap clamp : 8498-04

Spare strap : 8498-103

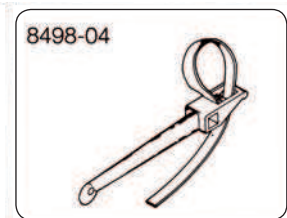
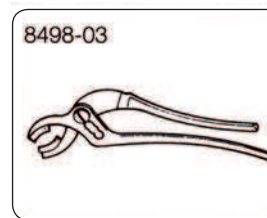

Tightening of fixing nuts, receptacle type 7

Shell size	09	11	13	15	17	19	21	23	25
Nut dimension across flats	22.35	25.55	30.30	33.45	36.65	39.80	43.00	46.10	50.95
Max tightening torque on nut (mN)	6	8	10	13	20	23	25	26	28

Tightening of rear accessories

Shell size	09	11	13	15	17	19	21	23	25
Max torque in m/daN	0.62						1.24		



Backshells

Basic type										8 LST	103	B	01	-
Shell size	09	11	13	15	17	19	21	23	25					
Index number	101	102	103	104	105	106	107	108	109					
Plating														
F: Nickel														
B: Olive green cadmium (MIL C 38999)														
Backshell type														
01: Backnut														
02: Straight cable clamp														
03: Elbow cable clamp														
07: Backshell for screen termination and heatshrink sleeving														
Suffix														
1: For backshell type 07 only - For receptacle type 0 (shells 09 to 25) and for plug type 5 (shells 09 to 23)														
None: For all other backshells														

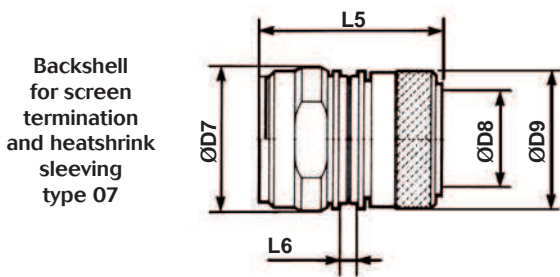

Shell size		09	11	13	15	17	19	21	23	25
D7 Max		20.20	23.20	26.20	29.20	32.20	35.20	39.20	42.20	45.20
D8	Min	6.90	9.60	12.70	14.80	17.90	19.90	23.10	26.20	28.80
	Max	7.00	9.70	12.80	14.90	18.00	20.00	23.20	26.30	28.90
D9 Max		16.00	18.90	22.10	25.30	28.50	31.50	34.70	37.90	41.00
L5 for receptacle type 0 - 3 - 1	T1	27.80	27.80	27.80	29.80	29.80	30.80	34.60	34.60	34.60
L5 Max for plug type 5	T1	27.80	27.80	27.80	29.80	29.80	30.80	34.60	34.60	-
L6 Max		3.40	3.40	3.40	3.40	3.40	3.40	3.40	3.40	3.40

8LT Series

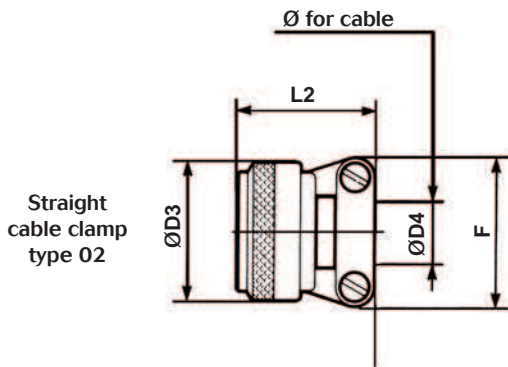
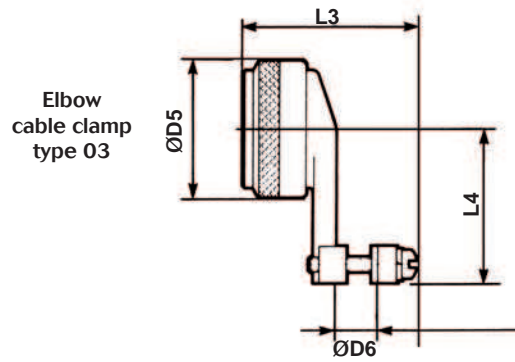
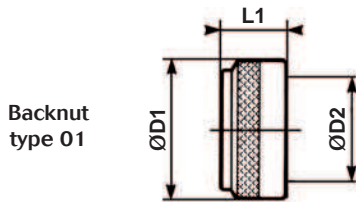

Shell size		09	11	13	15	17	19	21	23	25
D1 Max		15.67	18.64	21.79	24.99	28.24	30.94	34.16	37.29	40.46
D2 Max		6.96	10.46	13.36	16.53	19.71	22.40	25.56	28.75	31.93
L1 Max		11.30	11.30	11.30	11.30	11.30	11.30	11.30	11.30	11.30
D3 Max		15.67	18.64	21.79	24.99	28.24	30.94	34.16	37.29	40.46
D4	Min	1.40	1.40	2.40	5.60	5.60	8.80	11.90	15.10	15.10
	Max	3.20	4.80	6.40	9.50	12.70	15.90	19.10	22.20	25.40
F Max		21.03	22.63	25.81	28.98	30.56	37.31	37.31	42.06	44.45
L2 Max		22.22	22.22	22.22	28.57	28.57	28.57	28.57	31.75	31.75
L5 Max		47.22	48.02	49.52	55.92	59.42	59.42	59.42	59.42	59.42
D5 Max		15.67	18.64	21.79	24.99	28.24	30.94	34.16	37.29	40.46
D 6	Max	3.20	4.00	4.80	5.50	6.40	7.90	9.50	10.30	14.30
	Min	6.40	9.50	11.10	14.30	15.90	19.10	22.20	23.80	25.40
L3 Max		35.32	35.32	37.30	41.67	46.04	46.45	48.43	51.98	54.78
L4 Max		25.40	26.19	27.79	30.96	32.54	34.14	34.93	36.53	43.66



Cost effective & light hermetics / Resin sealed

Presentation

- Potted receptacle with male or female straight spill contacts
- 100% scoop proof: no perturbation when locking the connector, contacts never touch each other

Characteristics

- Weight saving compared to hermetic version
- Reinforced sealing for harsh environment ($10E^{-7}$ atm.cm³/s)

Comparison between standard and hermetic version

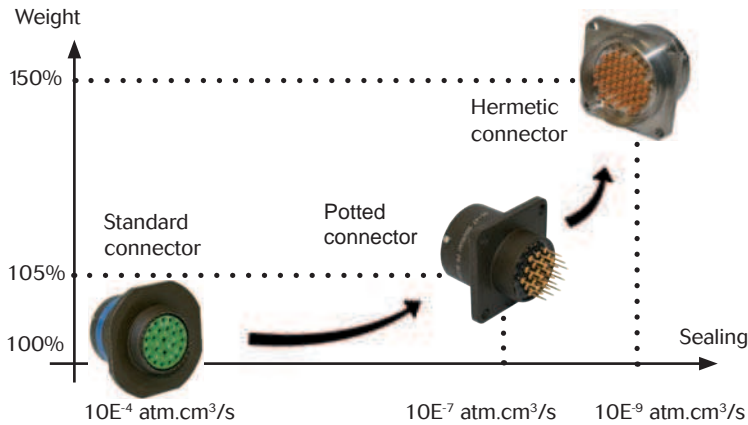

- Good shock resistance - better than hermetic glass seal
- Female contacts available for the receptacle

Contact layout

- PC Tail from #22D to #16 for all other contacts please consult us.



Cost effective & light hermetics / Resin sealed Souriau Part Numbers

Basic Series	8LTR	0	C	09	B	35	P	N
Shell style 0: Square flange receptacle 1: cable connecting receptacle 2: Short square flange receptacle not accepting backshell 3: Square flange receptacle (rear mounting) 5: Plug with RFI shielding 15 : Plug with RFI shielding not accepting backshell 7: Jam nut receptacle								
Type C: Receptacle with short spill (male and female #22D, #20, #16) L: Connector with long spill (male and female #22D) S: Connector with specific PC Tail (male and female #22D) M: Connector with average spill (male #22D) P: Connector with solder cup: . Pin: #22D & #16; Socket: #12 . Socket: #22D & #16; Pin: #12 - Please consult us								
Shell size: 09 - 11 - 13 - 15 - 17 - 19 - 21 - 23 - 25								
Plating B: Olive green cadmium F: Nickel Z: Green zinc cobalt L: Black zinc nickel								
Contact layouts: see tables pages 14 to 19								
Contact type P: Male S: Female								
Orientation (1) N - A - B - C - D see table page 37								

(1) Orientation B & C not developed for shell size number 9



Coordinate for PC tail terminations

Contact identification - front face view of male insulator

Holes sizes : 1 mm min (#22 and #20 contacts) and 1.3 mm min (#16 contact) coordinates in mm.

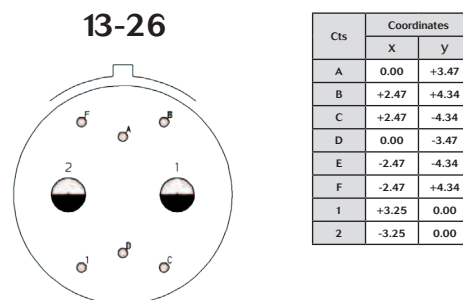
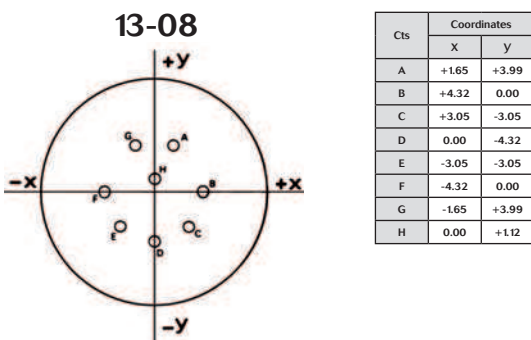
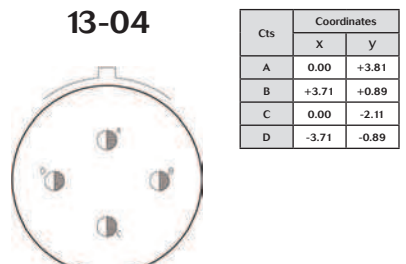
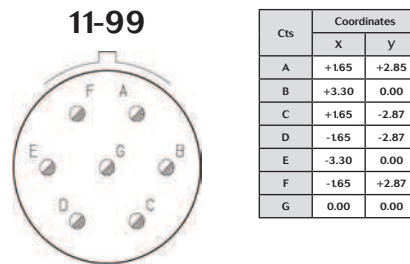
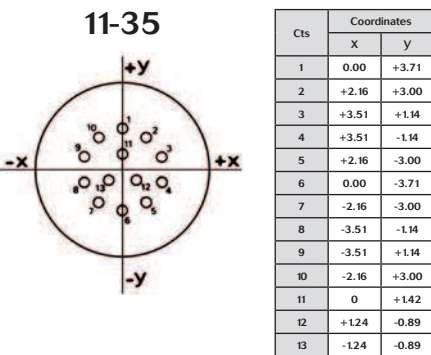
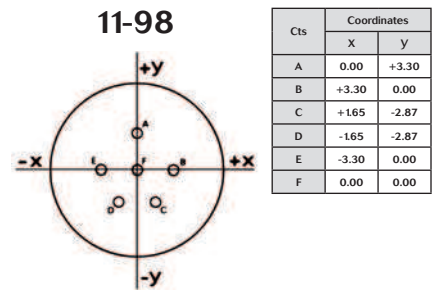
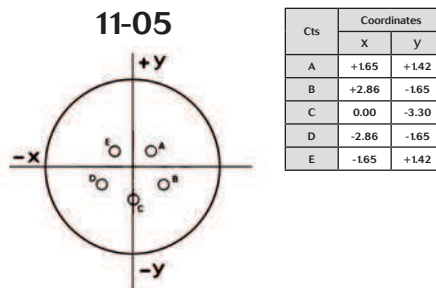
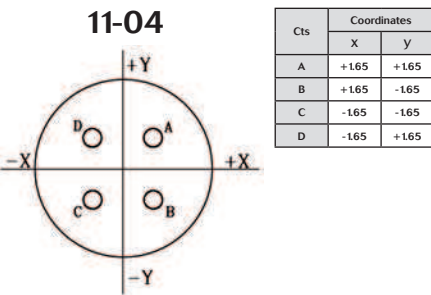
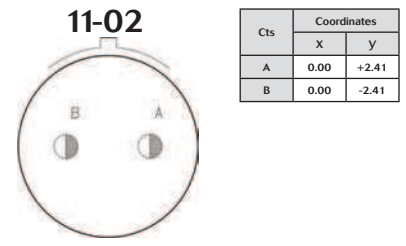
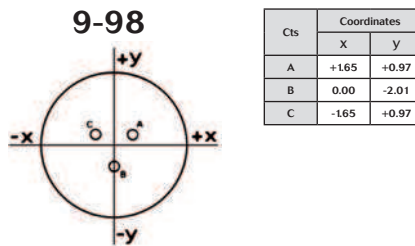
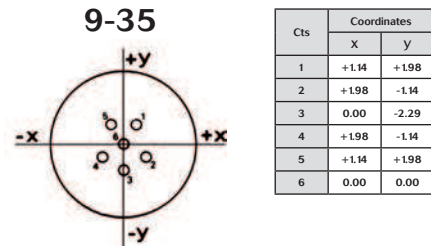



13-35

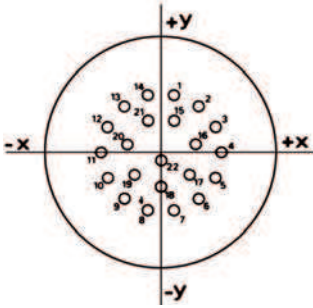

Cts	Coordinates		Cts	Coordinates	
	x	y		x	y
1	+1.14	+5.00	12	-4.62	+2.24
2	+3.20	+4.01	13	-3.20	+4.01
3	+4.62	+2.24	14	-1.14	+5.00
4	+5.16	0.00	15	+1.14	+2.72
5	+4.62	-2.24	16	+2.97	+0.66
6	+3.20	-4.01	17	+2.36	-1.91
7	+1.14	-5.00	18	0.00	-3.05
8	-1.14	-5.00	19	-2.36	-1.91
9	-3.20	-4.01	20	-2.97	+0.66
10	-4.62	-2.24	21	-1.14	+2.72
11	-5.16	0.00	22	0.00	-0.76

13-98

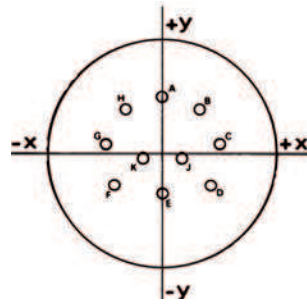

Cts	Coordinates	
	X	Y
A	0.00	+4.95
B	+3.18	+3.81
C	+4.90	+0.76
D	+4.17	-2.67
E	0.00	-3.43
F	-4.17	-2.67
G	-4.90	+0.76
H	-3.18	+3.81
J	+1.65	-0.38
K	-1.65	-0.38

15-05

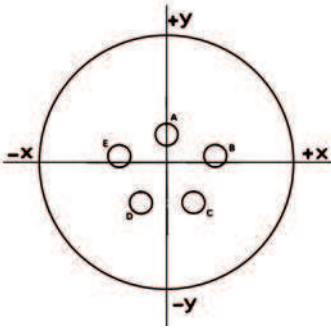

Cts	Coordinates	
	x	y
A	0	+2.54
B	+4.42	+0.61
C	+2.39	+3.76
D	-2.39	-3.76
E	-4.42	+0.61

15-15

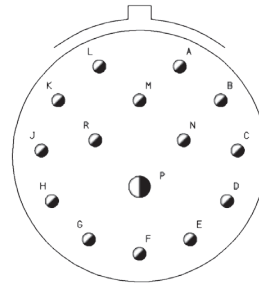

Cts	Coordinates		Cts	Coordinates	
	X	Y		X	Y
A	+2.54	+5.72	J	-6.20	+0.36
B	+5.13	+3.56	K	-5.13	+3.56
C	+6.20	+0.36	L	-2.54	+5.72
D	+5.54	-2.87	M	0.00	+3.56
E	+3.20	-5.31	N	+2.79	+1.02
F	0.00	-6.22	P	0.00	-1.96
G	-3.20	-5.31	R	-2.79	+1.02
H	-5.54	-2.87			

15-18

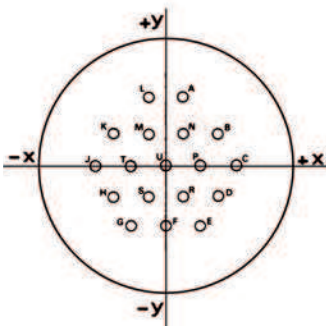

Cts	Coordinates		Cts	Coordinates	
	x	y		x	y
A	+1.65	+6.40	K	-4.95	+2.87
B	+4.95	+2.87	L	-1.65	+6.40
C	+6.60	0.00	M	-1.65	+2.87
D	+4.95	-2.87	N	+1.65	+2.87
E	+3.30	-5.72	P	+3.30	0.00
F	0.00	-5.72	R	+1.65	-2.87
G	-3.30	-5.72	S	-1.65	-2.87
H	-4.95	-2.87	T	-3.30	0.00
J	-6.60	0.00	U	0.00	0.00

15-19

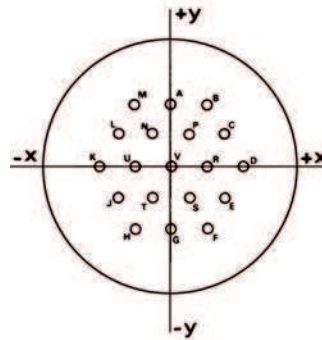

Cts	Coordinates		Cts	Coordinates	
	X	Y		X	Y
A	0.00	+5.72	L	-4.95	+2.87
B	+3.30	+5.72	M	-3.30	+5.72
C	+4.95	+2.87	N	-1.65	+2.87
D	+6.60	0.00	P	+1.65	+2.87
E	+4.95	-2.87	R	+3.30	0.00
F	+3.30	-5.72	D	+1.65	-2.87
G	0.00	-5.72	T	-1.65	-2.87
H	-3.30	-5.72	U	-3.30	0.00
J	-4.95	-2.87	V	0.00	0.00
K	-6.60	0.00			

15-35

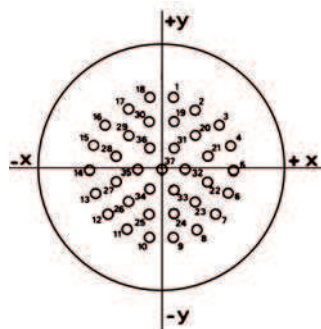

Cts	Coordinates		Cts	Coordinates	
	X	Y		X	Y
1	+1.14	+6.65	20	+3.12	+3.02
2	+3.12	+5.51	21	+4.32	+1.02
3	+5.36	+4.06	22	+4.32	-1.27
4	+6.45	+2.03	23	+3.12	-3.23
5	+6.75	-0.25	24	+1.14	-4.37
6	+6.27	-2.49	25	-1.14	-4.37
7	+5.08	-4.45	26	-3.12	-3.23
8	+3.30	-5.89	27	-4.32	-1.27
9	+1.14	-6.65	28	-4.32	+1.02
10	-1.14	-6.65	29	-3.12	+3.02
11	-3.30	-5.89	30	-1.14	+4.37
12	-5.08	-4.45	31	+1.14	+1.88
13	-6.27	-2.49	32	+2.29	-0.10
14	-6.76	-0.25	33	+1.14	-2.08
15	-6.45	+2.03	34	-1.14	-2.08
16	-5.36	+4.06	35	-2.29	-0.10
17	-3.12	+5.51	36	-1.14	+1.88
18	-1.14	+6.65	37	0.00	-0.10
19	+1.14	+4.37			

15-97

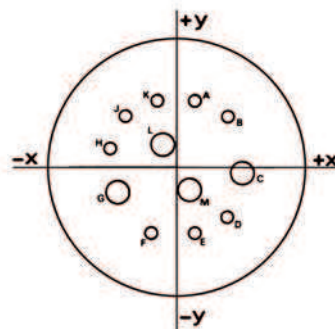

Cts	Coordinates		Cts	Coordinates	
	X	Y		X	Y
A	+1.65	+5.94	G	-5.26	-2.41
B	+4.52	+4.52	H	-5.94	+1.65
C	+5.84	-0.58	J	-4.52	+4.52
D	+4.52	-4.52	K	-1.65	+5.94
E	+1.65	-5.94	L	-1.19	+2.06
F	-2.26	-5.97	M	+1.19	-2.06

8LT Series



17-06

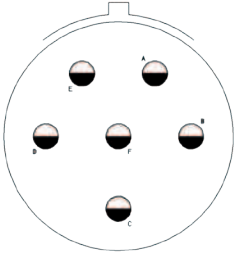

Cts	Coordinates	
	X	y
A	+3.07	+5.31
B	+6.12	0.00
C	0.00	-6.12
D	-6.12	0.00
E	-3.07	+5.31
F	0.00	0.00

17-08

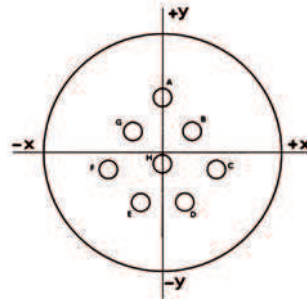

Cts	Coordinates	
	X	y
A	0.00	+5.99
B	+3.25	+2.18
C	+5.84	-1.98
D	+2.39	-5.49
E	-2.39	-5.49
F	-5.84	-1.98
G	-3.25	+2.18
H	0.00	-1.32

17-26

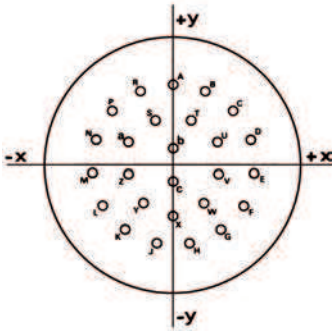

Coordinates			Coordinates		
Cts	X	y	Cts	X	y
A	0.00	+8.15	P	-6.07	+5.44
B	+3.33	+7.44	R	-3.33	+7.44
C	+6.07	+5.44	S	-1.78	+4.50
D	+7.75	+2.51	T	+1.78	+4.50
E	+8.10	-0.86	U	+4.45	+2.39
F	+7.06	-4.09	V	+4.53	+0.91
G	+4.80	-6.60	W	+3.02	-3.84
H	+1.70	-7.98	X	0.00	-5.16
J	-1.70	-7.98	Y	-3.02	-3.84
K	-4.80	-6.60	Z	-4.53	-0.91
L	-7.06	-4.09	a	-4.45	+2.39
M	-8.10	-0.86	b	0.00	+1.65
N	-7.75	+2.51	c	0.00	-1.65

17-35

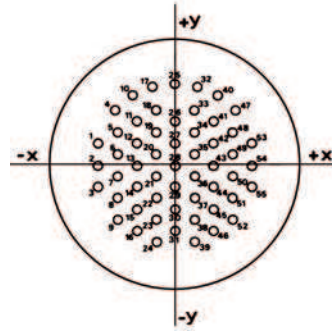

Coordinates			Coordinates		
Cts	X	y	Cts	X	y
1	-7.92	+2.18	29	0.00	-2.39
2	-7.92	-0.10	30	0.00	+4.67
3	-7.92	-2.39	31	0.00	-6.96
4	-6.15	+5.61	32	+2.26	+8.03
5	-5.94	+3.33	33	+1.98	+5.61
6	-5.94	+1.04	34	+1.98	+3.33
7	-5.94	-1.24	35	+1.98	+1.04
8	-5.94	-3.53	36	+1.98	-1.24
9	-5.94	-5.82	37	+1.98	-3.53
10	-4.37	+7.09	38	+1.98	-5.82
11	-3.96	+4.47	39	+1.98	-8.10
12	-3.96	+2.18	40	+4.37	+7.09
13	-3.96	-0.10	41	+3.96	+4.47
14	-3.96	-2.39	42	+3.96	+2.18
15	-3.96	-4.67	43	+3.96	-0.10
16	-3.96	-6.96	44	+3.96	-2.39
17	-2.26	+8.03	45	+3.96	-4.67
18	-1.98	+5.61	46	+3.96	-6.96
19	-1.98	+3.33	47	+6.15	+5.61
20	-1.98	+1.04	48	+5.94	+3.33
21	-1.98	-1.24	49	+5.94	+1.04
22	-1.98	-3.53	50	+5.94	-1.24
23	-1.98	-5.82	51	+5.94	-3.53
24	-1.98	-8.10	52	+5.94	-5.82
25	0.00	+8.36	53	+7.92	+2.18
26	0.00	+4.47	54	+7.92	-0.10
27	0.00	+2.18	55	+7.92	-2.39
28	0.00	-0.10			

17-80

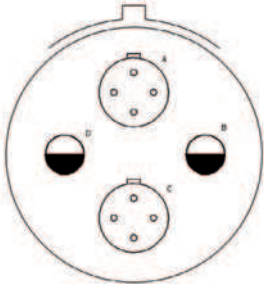

Cts	Coordinates	
	X	y
A	0.00	+4.57
B	+6.32	0.00
C	0.00	-4.57
D	-6.32	0.00

17-81

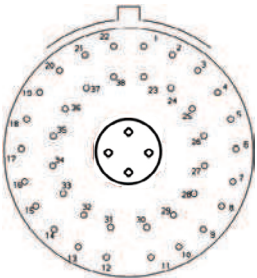

Coordinates			Coordinates		
Cts	X	y	Cts	X	y
1	+1.17	+8.26	21	-3.38	+7.59
2	+3.38	+7.59	22	-1.17	+8.26
3	+5.36	+6.38	23	+1.17	+5.87
4	+6.91	+4.65	24	+3.28	+5.00
5	+7.92	+2.57	25	+4.93	+3.38
6	+8.33	+0.28	26	+5.84	+1.27
7	+8.08	-2.01	27	+5.89	-1.02
8	+7.21	-4.17	28	+5.08	-3.18
9	+5.79	-5.99	29	+3.48	-4.85
10	+3.91	-7.34	30	+1.40	-5.82
11	+1.73	-8.15	31	-1.40	-5.82
12	-1.73	-8.15	32	-3.48	-4.85
13	-3.91	-7.34	33	-5.08	-3.18
14	-5.79	-5.99	34	-5.89	-1.02
15	-7.21	-4.17	35	-5.84	+1.27
16	-8.08	-2.01	36	-4.93	+3.38
17	-8.33	+0.28	37	-3.28	+5.00
18	-7.92	+2.57	38	-1.17	+5.87
19	-6.91	+4.65	39	0.00	0.00
20	-5.36	+6.38			

17-82

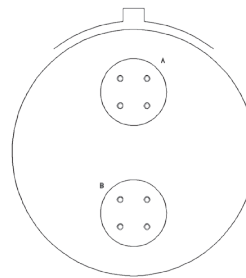

Cts	Coordinates	
	X	y
A	0.00	+4.75
B	0.00	-4.75

8LT Series



17-99

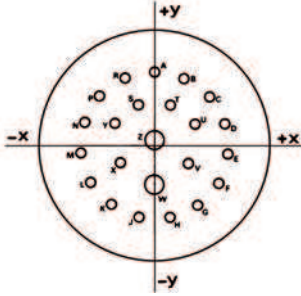

Cts	Coordinates		Cts	Coordinates	
	X	y		X	y
A	0.00	+8.15	N	-7.75	+2.51
B	+3.33	+7.44	P	-6.07	+5.44
C	+6.07	+5.44	R	-3.33	+7.44
D	+7.75	+2.51	S	-1.78	+4.50
E	+8.10	-0.86	T	+1.78	+4.50
F	+7.06	-4.09	U	+4.45	+2.39
G	+4.80	-6.60	V	+3.81	-1.91
H	+1.70	-7.98	W	0.00	-4.09
J	-1.70	-7.98	X	-3.81	-1.91
K	-4.80	-6.60	Y	-4.45	+2.39
L	-7.06	-4.09	Z	0.00	+0.64
M	-8.10	-0.86			

19-11

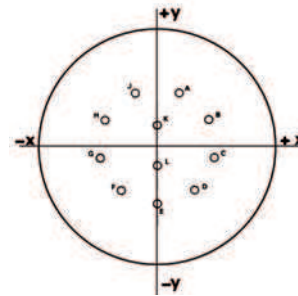

Cts	Coordinates	
	X	y
A	+2.67	+6.60
B	+6.35	+3.35
C	+6.99	-1.35
D	+4.55	-5.46
E	0.00	-7.14
F	-4.55	-5.46
G	-6.99	-1.35
H	-6.35	+3.35
J	-2.67	+6.60
K	0.00	+2.67
L	0.00	-2.34

19-28

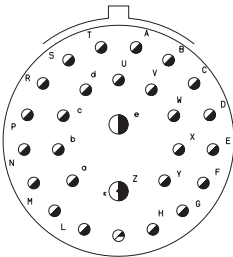

Cts	Coordinates		Cts	Coordinates	
	X	y		X	y
A	+1.68	+8.97	R	-7.26	+5.51
B	+4.80	+7.75	S	-4.80	+7.75
C	+7.26	+5.51	T	-1.68	+8.97
D	+8.76	+2.49	U	0.00	+5.84
E	+9.07	-0.84	V	+3.15	+4.90
F	+8.15	-4.06	W	+5.31	+2.41
G	+6.15	-6.73	X	+5.79	-0.84
H	+3.30	-8.51	Y	+4.42	-3.84
J	0.00	-9.12	Z	0.00	-4.85
K	-3.30	-8.51	a	-4.42	-3.84
L	-6.15	-6.73	b	-5.79	-0.84
M	-8.15	-4.06	c	-5.31	+2.41
N	-9.07	-0.84	d	-3.15	+4.90
P	-8.76	+2.49	e	0.00	+1.57

19-32

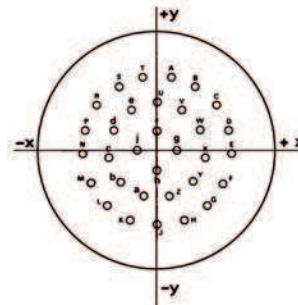

Cts	Coordinates		Cts	Coordinates	
	x	y		x	y
A	+1.68	+8.97	T	-1.68	+8.97
B	+4.80	+7.75	U	0.00	+5.84
C	+7.26	+5.51	V	+3.15	+4.90
D	+8.76	+2.49	W	+5.31	+2.41
E	+9.07	-0.84	X	+5.79	-0.84
F	+8.15	-4.06	Y	+4.42	-3.84
G	+6.15	-6.73	Z	+1.65	-5.61
H	+3.30	-8.51	a	-1.65	-5.61
J	0.00	-9.12	b	-4.42	-3.84
K	-3.30	-8.51	c	-5.79	-0.84
L	-6.15	-6.73	d	-5.31	+2.41
M	-8.15	-4.06	e	-3.15	+4.90
N	-9.07	-0.84	f	0.00	+2.44
p	-8.76	+2.49	g	+2.44	0.00
R	-7.26	+5.51	h	0.00	-2.44
S	-4.80	+7.75	j	-2.44	0.00

19-35

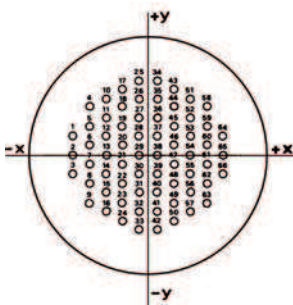

Cts	Coordinates		Cts	Coordinates	
	X	y		X	y
1	-9.07	+2.29	34	+1.14	+9.14
2	-9.07	+0.08	35	+1.14	+6.86
3	-9.07	-2.29	36	+1.14	+4.57
4	-7.09	+5.72	37	+1.14	+2.29
5	-7.09	+3.43	38	+1.14	0.00
6	-7.09	+1.14	39	+1.14	-2.29
7	-7.09	-1.14	40	+1.14	-4.57
8	-7.09	-3.43	41	+1.14	-6.86
9	-7.09	-5.72	42	+1.14	-9.14
10	-5.11	+6.86	43	+3.12	+8.00
11	-5.11	+4.57	44	+3.12	+5.72
12	-5.11	+2.29	45	+3.12	+3.43
13	-5.11	0.00	46	+3.12	+1.14
14	-5.11	-2.29	47	+3.12	-1.14
15	-5.11	-4.57	48	+3.12	-3.43
16	-5.11	-6.86	49	+3.12	-5.72
17	-3.12	+8.00	50	+3.12	-8.00
18	+3.12	+5.72	51	+5.11	+6.86
19	-3.12	+3.43	52	+5.11	+4.57
20	-3.12	+1.14	53	+5.11	+2.29
21	-3.12	-1.14	54	+5.11	0.00
22	-3.12	-3.43	55	+5.11	-2.29
23	-3.12	-5.72	56	+5.11	-4.57
24	-3.12	-8.00	57	+5.11	-6.86
25	-1.14	+9.14	58	+7.09	+5.72
26	-1.14	+6.86	59	+7.09	+3.43
27	-1.14	+4.57	60	+7.09	+1.14
28	-1.14	+2.29	61	+7.09	-1.14
29	-1.14	0.00	62	+7.09	-3.43
30	-1.14	-2.29	63	+7.09	-5.72
31	-1.14	-4.57	64	+9.07	+2.29
32	-1.14	-6.86	65	+9.07	0.00
33	-1.14	-9.14	66	+9.07	-2.29

19-84

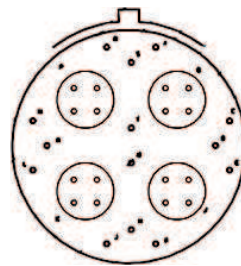

Cts	Coordinates	
	x	y
A	+1.73	+9.65
B	+4.57	+4.57
C	+9.58	+1.65
D	+8.05	0.00
E	+9.58	-1.65
F	+4.57	-4.57
G	+1.73	-9.65
H	0.00	-8.10
J	-1.73	-9.65
K	-4.57	-4.57
L	-9.58	-1.65
M	-8.05	0.00
N	-9.58	+1.65
p	-4.57	+4.57
R	-1.73	+9.65
S	0.00	+8.10
T	0.00	+1.12
U	0.00	-1.12

8LT Series



21-11

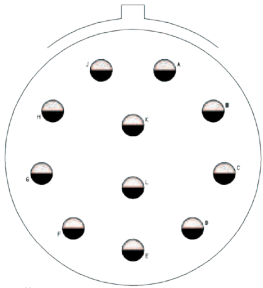

Cts	Coordinates	
	X	y
A	+3.07	+8.43
B	+7.77	+4.50
C	+8.84	-1.55
D	+5.77	-6.86
E	0.00	-8.97
F	-5.77	-6.86
G	-8.84	-1.55
H	-7.77	+4.50
J	-3.07	+8.43
K	0.00	+3.12
L	0.00	-2.92

21-16

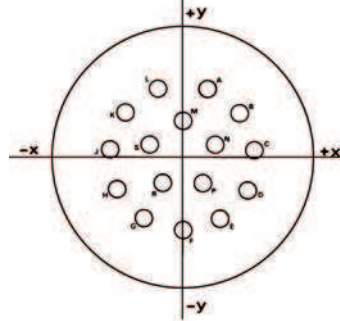

Cts	Coordinates		Cts	Coordinates	
	X	y		X	y
A	+3.00	+8.18	J	-8.66	+0.91
B	+6.88	+5.36	K	-6.88	+5.36
C	+8.66	+0.91	L	-3.00	+8.18
D	+7.82	-3.81	M	0.00	+4.45
E	+4.62	-7.37	N	+3.91	+1.57
F	0.00	-8.71	P	+2.39	-3.10
G	-4.62	-7.37	R	-2.39	-3.10
H	-7.82	-3.81	S	-3.91	+1.57

21-35

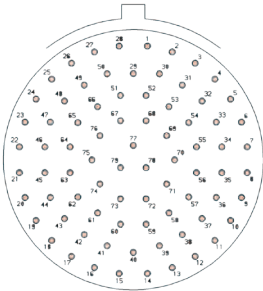

Cts	Coordinates		Cts	Coordinates	
	X	y		X	y
1	+1.35	+10.82	41	-2.49	-8.18
2	+3.71	+10.26	42	-4.67	-7.11
3	+5.89	+9.19	43	-6.55	-5.59
4	+7.77	+7.67	44	-7.90	-3.58
5	+9.27	+5.77	45	-8.43	-1.22
6	+10.31	+3.58	46	-8.43	+1.22
7	+10.85	+1.22	47	-7.90	+3.58
8	+10.85	-1.22	48	-6.55	+5.59
9	+10.31	-3.58	49	-4.67	+7.11
10	+9.27	-5.77	50	-2.49	+8.18
11	+7.77	-7.67	51	-1.22	+6.12
12	+5.89	-9.19	52	+1.22	+6.12
13	+3.71	-10.26	53	+3.40	+5.05
14	+1.35	-10.82	54	+5.28	+3.53
15	-1.35	-10.82	55	+6.02	+1.22
16	-3.71	-10.26	56	+6.02	-1.22
17	-5.89	-9.19	57	+5.28	-3.53
18	-7.77	-7.67	58	+3.40	-5.05
19	-9.27	-5.77	59	+1.22	-6.12
20	-10.31	-3.58	60	-1.22	-6.12
21	-10.85	-1.22	61	-3.40	-5.05
22	-10.85	+1.22	62	-5.28	-3.53
23	-10.31	+3.58	63	-6.02	-1.22
24	-9.27	+5.77	64	-6.02	+1.22
25	-7.77	+7.67	65	-5.28	+3.53
26	-5.89	+9.19	66	-3.40	+5.05
27	-3.71	+10.26	67	-1.22	+3.71
28	-1.35	+10.82	68	+1.22	+3.71
29	0.00	+8.20	69	+3.18	+2.29
30	+2.49	+8.18	70	+3.94	0.00
31	+4.67	+7.11	71	+3.18	-2.29
32	+6.55	+5.59	72	+1.22	-3.71
33	+7.90	+3.58	73	-1.22	-3.71
34	+8.43	+1.22	74	-3.18	-2.29
35	+8.43	-1.22	75	-3.94	0.00
36	+7.90	-3.58	76	-3.18	+2.29
37	+6.55	-5.59	77	0.00	+1.35
38	+4.67	-7.11	78	+1.22	-0.74
39	+2.49	-8.18	79	-1.22	-0.74
40	0.00	-8.81			

21-39

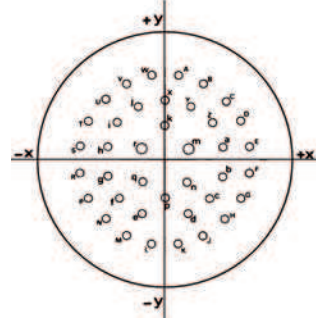

Cts	Coordinates		Cts	Coordinates	
	X	y		X	y
A	+1.65	+10.44	X	0.00	+7.49
B	+4.80	+9.42	Y	+3.20	+6.50
C	+7.47	+7.47	Z	+5.89	+4.55
D	+9.42	+4.80	a	+7.11	+1.45
E	+10.44	+1.65	b	+7.11	-1.88
F	+10.44	-1.65	c	+5.51	-4.80
G	+9.42	-4.80	d	+2.84	-6.73
H	+7.47	-7.47	e	-2.84	-6.73
J	+4.80	-9.42	f	-5.51	-4.80
K	+1.65	-10.44	g	-7.11	-1.88
L	-1.65	-10.44	h	-7.11	+1.45
M	-4.80	-9.42	i	-5.89	+4.55
N	-7.47	-7.47	j	-3.20	+6.50
P	-9.42	-4.80	k	0.00	+4.17
R	-10.44	-1.65	m	+2.90	+1.22
S	-10.44	+1.65	n	+2.69	-2.72
T	-9.42	+4.80	p	0.00	-4.80
U	-7.47	+7.47	q	-2.69	-2.72
V	-4.80	+9.42	r	-2.90	+1.22
W	-1.65	+10.44			

21-84

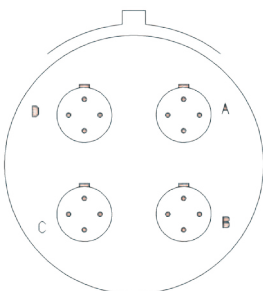

Cts	Coordinates	
	X	y
A	+4.57	+4.57
B	+4.57	-4.57
C	-4.57	-4.57
D	-4.57	+4.57

21-41

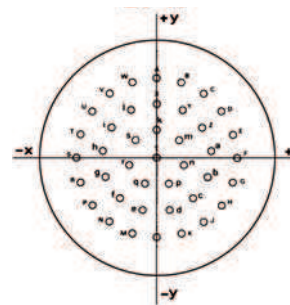

Cts	Coordinates		Cts	Coordinates	
	X	y		X	y
A	0.00	+10.60	y	+3.35	+6.38
B	+3.28	+10.09	Z	+5.92	+4.09
C	+6.23	+8.58	a	+7.15	+0.87
D	+8.58	+6.23	b	+6.73	-2.55
E	+10.09	+3.28	c	+4.78	-5.39
F	+10.60	0.00	d	+1.73	-6.99
G	+10.09	-3.28	e	-1.73	-6.99
H	+8.58	-6.23	f	-4.78	-5.39
J	+6.23	-8.58	g	-6.73	-2.55
K	+3.28	-10.09	h	-7.15	+0.87
L	0.00	-10.60	i	-5.92	+4.09
M	-3.26	-10.09	j	-3.35	+6.38
N	-6.23	-8.58	k	0.00	+3.81
P	-8.58	-6.23	m	+2.98	+2.38
R	-10.09	-3.28	n	+3.71	-0.85
S	-10.60	0.00	p	-1.66	-3.43
T	-10.09	+3.28	q	+1.66	-3.43
U	-8.58	+6.23	r	-3.71	-0.85
V	-6.23	+8.58	s	-2.98	+2.38
W	-3.28	+10.09	t	0.00	0.00
X	0.00	+7.20			

8LT Series



23-21

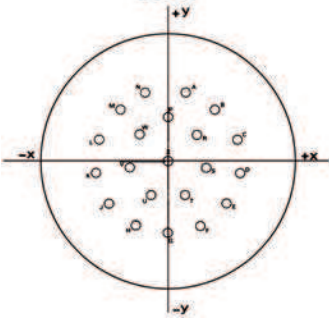

Cts	Coordinates		Cts	Coordinates	
	X	y		X	y
A	+3.25	+9.78	M	-7.34	+7.24
B	+7.34	+7.24	N	-3.25	+9.78
C	+9.80	+3.12	P	0.00	+6.22
D	+10.16	-1.65	R	+4.06	+3.71
E	+8.33	-6.07	S	+5.44	-0.89
F	+4.65	-9.19	T	+2.39	-4.93
G	0.00	-10.31	U	-2.39	-4.93
H	-4.65	-9.19	V	-5.44	-0.89
J	-8.33	-6.07	W	-4.06	+3.71
K	-10.16	-1.65	X	0.00	0.00
L	-9.80	+3.12			

23-32

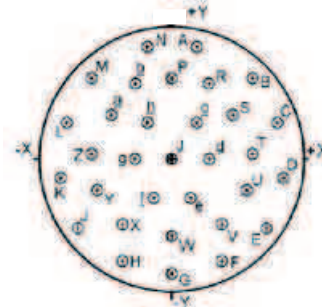

Cts	Coordinates		Cts	Coordinates	
	X	y		X	y
A	+2.54	+11.43	T	+8.26	+0.64
B	+8.26	+8.26	U	+7.62	-3.18
C	+10.80	+3.81	V	+5.08	-6.35
D	+11.43	-1.91	W	0.00	-7.62
E	+9.53	-6.99	X	-5.08	-6.35
F	+5.08	-10.16	Y	-7.62	-3.18
G	0.00	-11.43	Z	-8.26	+0.64
H	-5.08	-10.16	a	-6.35	+4.45
J	-9.53	-6.99	b	-3.81	+7.62
K	-11.43	-1.91	c	+2.54	+3.81
L	-10.80	+3.81	d	+3.81	0.00
M	-8.26	+8.26	e	+1.91	-3.81
N	-2.54	+11.43	f	-1.91	-3.81
P	0.00	+8.26	g	-3.81	0.00
R	+3.81	+7.62	h	-2.54	+3.81
S	+6.35	+4.45	j	0.00	0.00

23-35

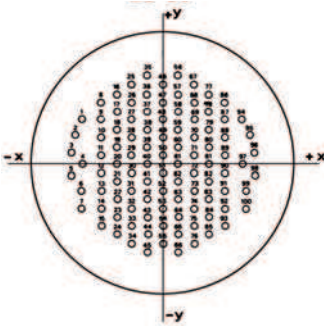

Cts	Coordinates		Cts	Coordinates	
	X	y		X	y
1	-10.87	+6.12	51	0.00	-1.19
2	-11.86	+3.91	52	0.00	-3.61
3	-12.40	+1.55	53	0.00	-6.02
4	-10.54	0.00	54	0.00	-8.43
5	-12.40	-1.55	55	0.00	-10.85
6	-10.87	-3.61	56	+2.11	+12.07
7	-10.87	-6.02	57	+2.11	+9.65
8	-8.43	+8.46	58	+2.11	+7.24
9	-8.43	+6.05	59	+2.11	+4.83
10	-8.43	+3.63	60	+2.11	+2.41
11	-8.43	+1.22	61	+2.11	0.00
12	-8.43	-1.19	62	+2.11	-2.41
13	-8.43	-3.61	63	+2.11	-4.83
14	-8.43	-6.02	64	+2.11	-7.24
15	-8.43	-8.43	65	+2.11	-9.65
16	-6.32	+9.65	66	+2.11	-12.07
17	-6.32	+7.24	67	+4.22	+10.87
18	-6.32	+4.83	68	+4.22	+8.46
19	-6.32	+2.41	69	+4.22	+6.05
20	-6.32	0.00	70	+4.22	+3.63
21	-6.32	-2.41	71	+4.22	+1.22
22	-6.32	-4.83	72	+4.22	-1.19
23	-6.32	-7.24	73	+4.22	-3.61
24	-6.32	-9.65	74	+4.22	-6.02
25	-4.22	+10.87	75	+4.22	-8.43
26	-4.22	+8.46	76	+4.22	-10.85
27	-4.22	+6.05	77	+6.32	+9.65
28	-4.22	+3.63	78	+6.32	+7.24
29	-4.22	+1.22	79	+6.32	+4.83
30	-4.22	-1.19	80	+6.32	+2.41
31	-4.22	-3.61	81	+6.32	0.00
32	-4.22	-6.02	82	+6.32	-2.41
33	-4.22	-8.43	83	+6.32	-4.83
34	-4.22	-10.85	84	+6.32	-7.24
35	-2.11	+12.07	85	+6.32	-9.65
36	-2.11	+9.65	86	+8.43	+8.46
37	-2.11	+7.24	87	+8.43	+6.05
38	-2.11	+4.83	88	+8.43	+3.63
39	-2.11	+2.41	89	+8.43	+1.22
40	-2.11	0.00	90	+8.43	-1.19
41	-2.11	-2.41	91	+8.43	-3.61
42	-2.11	-4.83	92	+8.43	-6.02
43	-2.11	-7.24	93	+8.43	-8.43
44	-2.11	-9.65	94	+10.87	+6.12
45	-2.11	-12.07	95	+11.86	+3.91
46	0.00	+10.87	96	+12.40	+1.55
47	0.00	+8.46	97	+10.54	0.00
48	0.00	+6.05	98	+12.40	-1.55
49	0.00	+3.63	99	+10.87	-3.61
50	0.00	+1.22	100	+10.87	-6.02

23-53

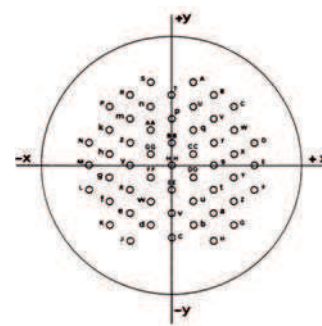

Cts	Coordinates		Cts	Coordinates	
	X	y		X	y
A	+2.84	+11.56	e	-5.72	-6.60
B	+5.72	+9.91	f	-8.53	-4.95
C	+8.53	+8.26	g	-8.53	-1.65
D	+11.43	+3.30	h	-8.53	+1.65
E	+11.43	0.00	k	-8.53	+4.95
F	+11.43	-3.30	m	-5.72	+6.60
G	+8.53	-8.26	n	-2.84	+8.26
H	+5.72	-10.41	p	0.00	+6.60
J	-5.72	-10.41	q	+2.84	+4.95
K	-8.53	-8.26	r	+5.72	+3.30
L	-11.43	-3.30	s	+5.72	0.00
M	-11.43	0.00	t	+5.72	-3.30
N	-11.43	+3.30	u	+2.84	-4.95
P	-8.53	+8.26	v	0.00	-6.60
R	-5.72	+9.91	w	-2.84	-4.95
S	-2.84	+11.56	x	-5.72	-3.30
T	0.00	+9.91	y	-5.72	0.00
U	+2.84	+8.26	z	-5.72	+3.30
V	+5.72	+6.60	AA	-2.84	+4.95
W	+8.53	+4.95	BB	0.00	+3.30
X	+8.53	+1.65	CC	+2.84	+1.65
Y	+8.53	-1.65	DD	+2.84	-1.65
Z	+8.53	-4.95	EE	0.00	-3.30
a	+5.72	-6.60	FF	-2.84	-1.65
b	+2.84	-8.26	GG	-2.84	+1.65
c	0.00	-9.91	HH	0.00	0.00
d	-2.84	-8.26			

23-54

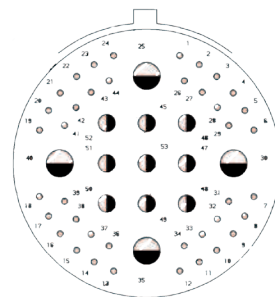

Cts	Coordinates		Cts	Coordinates	
	X	y		X	y
1	+3.61	+11.71	28	+7.72	+6.07
2	+5.74	+10.72	29	+8.97	+4.11
3	+7.65	+9.45	30	+9.50	0.00
4	+9.45	+7.65	31	+8.97	-4.11
5	+10.72	+5.74	32	+7.72	-6.07
6	+11.71	+3.61	33	+6.07	-7.72
7	+11.71	-3.61	34	+4.11	-8.97
8	+10.72	-5.74	35	0.00	-9.50
9	+9.45	-7.65	36	-4.11	-8.97
10	+7.65	-9.45	37	-6.07	-7.72
11	+5.74	-10.72	38	-7.72	-6.07
12	+3.61	-11.71	39	-8.97	-4.11
13	-3.61	-11.71	40	-9.50	0.00
14	-5.74	-10.72	41	-8.97	+4.11
15	-7.65	-9.45	42	-7.72	+6.07
16	-9.45	-7.65	43	-6.07	+7.72
17	-10.72	-5.74	44	-4.11	+8.97
18	-11.71	-3.61	45	0.00	+4.37
19	-11.71	+3.61	46	+4.37	+4.37
20	-10.72	+5.74	47	+4.37	0.00
21	-9.45	+7.65	48	+4.37	-4.37
22	-7.65	+9.45	49	0.00	-4.37
23	-5.74	+10.72	50	-4.37	-4.37
24	-3.61	+11.71	51	-4.37	0.00
25	0.00	+9.50	52	-4.37	+4.37
26	+4.11	+8.97	53	0.00	0.00
27	+6.07	+7.72			

8LT Series



23-55

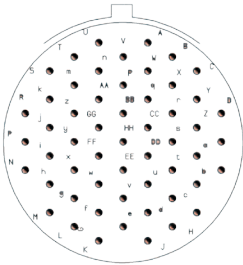

Cts	Coordinates		Cts	Coordinates	
	X	y		X	y
A	+2.84	+11.56	f	-2.84	-8.26
B	+5.72	+9.91	g	-5.72	-6.60
C	+8.53	+8.26	h	-8.53	-4.95
D	+11.43	+3.30	i	-8.53	-1.65
E	+11.43	0.00	j	-8.53	1.65
F	+11.43	-3.30	k	-8.53	+4.95
G	+8.53	-8.26	m	-5.72	+6.60
H	+5.72	-9.91	n	-2.84	+8.26
J	+2.84	-11.56	p	0.00	+6.60
K	-2.84	-11.56	q	+2.84	+4.95
L	-5.72	-9.91	r	+5.72	+3.30
M	-8.53	-8.26	s	+5.72	0.00
N	-11.43	-3.30	t	+5.72	-3.30
P	-11.43	0.00	u	+2.74	-4.95
R	-11.43	+3.30	v	0.00	-6.60
S	-8.53	+8.26	w	-2.84	-4.95
T	-5.72	+9.91	x	-5.72	-3.30
U	-2.74	+11.56	y	-5.72	0.00
V	0.00	+9.91	z	-5.72	+3.30
W	+2.84	+8.26	AA	-2.84	+4.95
X	+5.72	+6.60	BB	0.00	+3.30
Y	+8.53	+4.95	CC	+2.84	+1.65
Z	+8.53	+1.65	DD	+2.84	-1.65
a	+8.53	-1.65	EE	0.00	-3.30
b	+8.53	-4.95	FF	-2.84	-1.65
c	+5.72	-6.60	GG	-2.84	+1.65
d	+2.84	-8.26	HH	0.00	0.00
e	0.00	-9.91			

25-04

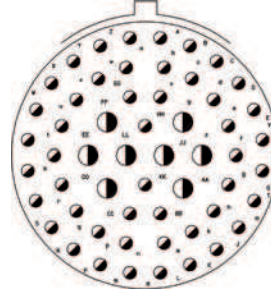

Cts	Coordinates		Cts	Coordinates	
	X	y		X	y
A	+1.75	+13.49	f	+10.46	0.00
B	+5.16	+12.57	g	+9.58	-3.35
C	+8.23	+10.80	h	+7.90	-6.38
D	+10.77	+8.28	k	+5.38	-8.78
E	+12.52	+5.21	m	+2.18	-10.08
F	+13.49	+1.75	n	-2.18	-10.08
G	+13.49	-1.75	p	-5.38	-8.78
H	+12.52	-5.21	q	-7.90	-6.38
J	+10.77	-8.28	r	-9.58	-3.35
K	+8.23	-10.80	s	-10.46	0.00
L	+5.16	-12.57	t	-9.58	+3.35
M	+1.75	-13.49	u	-7.90	+6.38
N	-1.75	-13.49	v	-5.38	+8.78
P	-5.16	-12.57	w	-2.18	+10.08
R	-8.23	-10.80	x	+1.75	+6.66
S	-10.77	-8.28	y	+4.37	+3.78
T	-12.52	-5.21	z	+6.55	0.00
U	-13.49	-1.75	AA	+4.37	-3.78
V	-13.49	+1.75	BB	+1.75	-6.66
W	-12.52	+5.21	CC	-1.75	-6.66
X	-10.77	+8.28	DD	-4.37	-3.78
Y	-8.23	+10.80	EE	-6.55	0.00
Z	-5.16	+12.57	FF	-4.37	+3.78
a	-1.75	+13.49	GG	-1.75	+6.66
b	+2.18	+10.08	HH	0.00	+3.35
c	+5.38	+8.78	JJ	+2.18	0.00
d	+7.90	+6.38	KK	0.00	-3.35
e	+9.58	+3.35	LL	+2.18	0.00

25-19

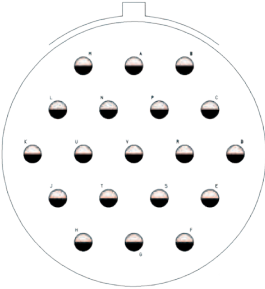

Cts	Coordinates		Cts	Coordinates	
	X	y		X	y
A	0.00	+10.39	L	-8.99	+5.21
B	+5.99	+10.39	M	-5.99	+10.39
C	+8.99	+5.21	N	-3.00	+5.21
D	+11.99	0.00	P	+3.00	+5.21
E	+8.99	-5.21	R	+5.99	0.00
F	+5.99	-10.39	S	+3.00	-5.21
G	0.00	-10.39	T	-3.00	-5.21
H	-5.99	-10.39	U	-5.99	0.00
J	-8.99	-5.21	V	0.00	0.00
K	-11.99	0.00			

25-24

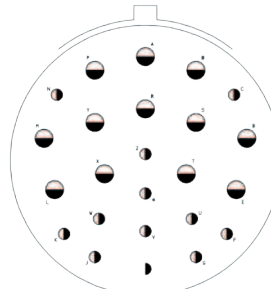

Cts	Coordinates		Cts	Coordinates	
	X	y		X	y
A	0.00	+11.99	N	-10.24	+7.57
B	+5.84	+10.41	P	-5.84	+10.41
C	+10.24	+7.57	R	0.00	+5.94
D	+11.71	+2.54	S	+5.84	+4.37
E	+10.49	-3.40	T	+4.72	-1.57
F	+9.40	-8.53	U	+5.36	-6.78
G	+5.84	-11.20	V	0.00	-8.20
H	0.00	-12.57	W	-5.36	-6.78
J	-5.84	-11.20	X	-4.72	-1.57
K	-9.40	-8.53	Y	-5.84	+4.37
L	-10.49	-3.40	Z	0.00	+0.71
M	-11.71	-2.54	a	0.00	-3.84

25-29

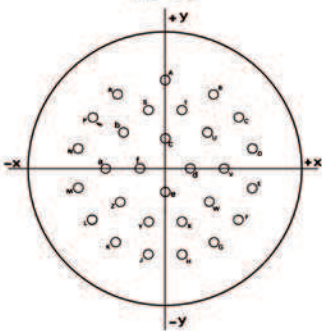

Cts	Coordinates		Cts	Coordinates	
	X	y		X	y
A	0.00	+12.22	S	-2.31	+8.15
B	+6.55	+10.31	T	+2.31	+8.15
C	+10.03	+7.04	U	+5.79	+4.93
D	+11.91	+2.77	V	+8.10	0.00
E	+11.91	-2.77	W	+6.10	-4.60
F	+10.03	-7.04	X	+2.31	-7.37
G	+6.68	-10.31	Y	-2.31	-7.37
H	+2.31	-11.99	Z	-6.10	-4.60
J	-2.31	-11.99	a	-8.10	0.00
K	-6.68	-10.31	b	-5.79	+4.93
L	-10.03	-7.04	c	0.00	+4.09
M	-11.91	-2.77	d	+3.40	0.00
N	-11.91	+2.77	e	0.00	-3.30
P	-10.03	+7.04	f	-3.40	0.00
R	-6.55	+10.31			

25-37

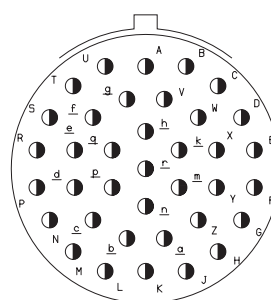

Cts	Coordinates		Cts	Coordinates	
	X	y		X	y
A	0.00	+11.99	W	+6.15	+5.99
B	+4.70	+11.99	X	+8.28	+2.18
C	+8.46	+9.70	Y	+8.28	-2.18
D	+11.20	+6.32	Z	+6.15	-5.99
E	+12.70	+2.18	a	+2.18	-8.13
F	+12.70	-2.18	b	-2.18	-8.13
G	+11.20	-6.32	c	-6.15	-5.99
H	+8.46	+9.70	d	-8.28	-2.18
J	+4.72	-11.99	e	-8.28	+2.18
K	0.00	-11.99	f	-6.15	+5.99
L	-4.72	-11.99	g	-2.18	+8.13
M	-8.46	-9.70	h	0.00	+4.37
N	-11.20	-6.32	k	+3.91	+2.18
P	-12.70	-2.18	m	+3.91	-2.18
R	-12.70	+2.18	n	0.00	-4.37
S	-11.20	+6.32	p	-3.91	-2.18
T	-8.46	+9.70	q	-3.91	+2.18
U	-4.72	+11.99	r	0.00	0.00
V	+2.18	+8.13			

8LT Series



25-35

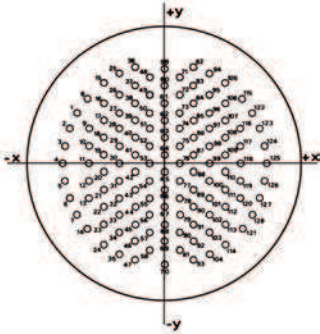

Cts	Coordinates		Cts	Coordinates		Cts	Coordinates		Cts	Coordinates		Cts	Coordinates		Cts	Coordinates	
	X	y		X	y		X	y		X	y		X	y		X	y
1	-12.17	+7.09	23	-8.43	-8.43	45	-4.22	-8.43	66	0.00	-3.61	87	+4.22	+1.19	108	+8.43	+3.61
2	-13.21	+4.83	24	-8.43	-10.85	46	-4.22	-10.85	67	0.00	-6.02	88	+4.22	-1.19	109	+8.43	+1.19
3	-13.87	+2.41	25	-6.32	+12.60	47	-4.22	-13.26	68	0.00	-8.43	89	+4.22	-3.61	110	+8.43	-1.19
4	-14.10	0.00	26	-6.32	+9.65	48	-2.11	+12.07	69	0.00	-10.85	90	+4.22	-6.02	111	+8.43	-3.61
5	-13.87	-2.41	27	-6.32	+7.24	49	-2.11	+9.65	70	0.00	-14.10	91	+4.22	-8.43	112	+8.43	-6.02
6	-13.21	-4.83	28	-6.32	+4.83	50	-2.11	+7.24	71	+2.11	+12.07	92	+4.22	-10.85	113	+8.43	-8.43
7	-12.17	-7.09	29	-6.32	+2.41	51	-2.11	+4.83	72	+2.11	+9.65	93	+4.22	-13.26	114	+8.43	-10.85
8	-10.77	+9.07	30	-6.32	0.00	52	-2.11	+2.41	73	+2.11	+7.24	94	+6.32	+12.60	115	+10.77	+9.07
9	-10.54	+4.83	31	-6.32	-2.41	53	-2.11	0.00	74	+2.11	+4.83	95	+6.32	+9.67	116	+10.54	+4.83
10	-10.54	+2.41	32	-6.32	-4.83	54	-2.11	-2.41	75	+2.11	+2.41	96	+6.32	+7.24	117	+10.54	+2.41
11	-10.54	0.00	33	-6.32	-7.24	55	-2.11	-4.83	76	+2.11	0.00	97	+6.32	+4.83	118	+10.54	0.00
12	-10.54	-2.41	34	-6.32	-9.65	56	-2.11	-7.24	77	+2.11	-2.41	98	+6.32	+2.41	119	+10.54	-2.41
13	-10.54	-4.83	35	-6.32	-12.07	57	-2.11	-9.65	78	+2.11	-4.83	99	+6.32	0.00	120	+10.54	-4.83
14	-10.77	-9.07	36	-4.06	+13.49	58	-2.11	-12.07	79	+2.11	-7.24	100	+6.32	-2.41	121	+10.77	-9.07
15	-8.43	+11.28	37	-4.22	+10.85	59	0.00	+13.26	80	+2.11	-9.65	101	+6.32	-4.83	122	+12.17	+7.09
16	-8.43	+8.43	38	-4.22	+8.43	60	0.00	+10.85	81	+2.11	-12.07	102	+6.32	-7.24	123	+13.21	+4.83
17	-8.43	+6.02	39	-4.22	+6.02	61	0.00	+8.43	82	+4.06	+13.49	103	+6.32	-9.65	124	+13.87	+2.41
18	-8.43	+3.61	40	-4.22	+3.61	62	0.00	+6.02	83	+4.22	+10.85	104	+6.32	-12.07	125	+14.10	0.00
19	-8.43	+1.19	41	-4.22	+1.19	63	0.00	+3.61	84	+4.22	+8.43	105	+8.43	+11.28	126	+13.87	-2.41
20	-8.43	-1.19	42	-4.22	-1.19	64	0.00	+1.19	85	+4.22	+6.02	106	+8.43	+8.43	127	+13.21	-4.83
21	-8.43	-3.61	43	-4.22	-3.61	65	0.00	-1.19	86	+4.22	+3.61	107	+8.43	+6.02	128	+12.17	-7.09
22	-8.43	-6.02	44	-4.22	-6.02												

25-43

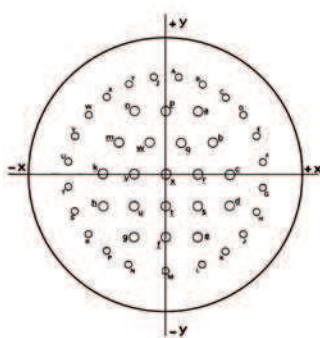

Cts	Coordinates		Cts	Coordinates	
	X	y		X	y
A	+1.75	+13.49	Z	-1.75	+13.49
B	+5.16	+12.57	a	+4.37	+8.74
C	+8.23	+10.80	b	+6.55	+4.37
D	+10.77	+8.28	c	+8.74	0.00
E	+12.52	+5.21	d	+8.74	-4.37
F	+13.49	+1.75	e	+4.37	-8.74
G	+13.49	-1.75	f	0.00	-8.74
H	+12.52	-5.21	g	-4.37	-8.74
J	+10.77	-8.28	h	-8.74	-4.37
K	+8.23	-10.80	k	-8.74	0.00
L	+5.16	-12.57	m	-6.55	+4.37
M	0.00	-13.49	n	-4.37	+8.74
N	-5.16	-12.57	p	0.00	+8.74
P	-8.23	-10.80	q	+2.18	+4.37
R	-10.77	-8.28	r	+4.37	0.00
S	-12.52	-5.21	s	+4.37	-4.37
T	-13.49	-1.75	t	0.00	-4.37
U	-13.49	+1.75	u	-4.37	-4.37
V	-12.52	+5.21	v	-4.37	0.00
W	-10.77	+8.28	w	-2.18	+4.37
X	-8.23	+10.80	x	0.00	0.00
Y	-5.16	+12.57			

25-61

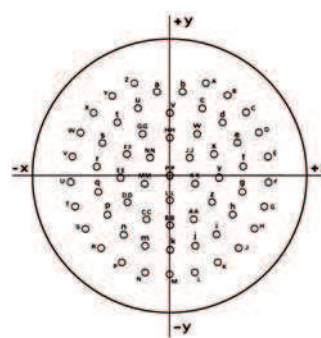

Cts	Coordinates		Cts	Coordinates	
	X	y		X	y
A	+4.98	+12.70	i	+6.38	-7.98
B	+7.98	+11.05	j	+3.38	-9.63
C	+10.49	+8.71	k	0.00	-10.21
D	+12.32	+5.84	m	-3.38	-9.63
E	+13.39	+2.57	n	-6.38	-7.98
F	+13.61	-0.76	p	-8.66	-5.41
G	+12.98	-4.17	q	-9.96	-2.24
H	+11.53	-7.29	r	-10.13	+1.17
J	+9.35	-9.93	s	-9.19	+4.45
K	+6.58	-11.94	t	-7.24	+7.19
L	+3.40	-13.18	u	-4.39	+9.22
M	0.00	-13.64	v	0.00	+8.59
N	-3.40	-13.18	w	+3.73	+5.66
P	-6.58	-11.94	x	+6.02	+3.10
R	-9.35	-9.93	y	+6.78	-0.25
S	-11.53	-7.29	z	+5.79	-3.53
T	-12.98	-4.17	AA	+3.33	-5.92
U	-13.61	-0.76	BB	0.00	-6.78
V	-13.39	+2.57	CC	-3.33	-5.92
W	-12.32	+5.84	DD	-5.79	-3.53
X	-10.49	+8.71	EE	-6.78	-0.25
Y	-7.98	+11.05	FF	-6.02	+3.10
Z	-4.98	+12.70	GG	-3.73	+5.66
a	-1.73	+11.53	HH	0.00	+5.08
b	+1.73	+11.53	JJ	+2.67	+2.39
c	+4.39	+9.22	KK	+3.43	-1.04
d	+7.24	+7.19	LL	0.00	-3.35
e	+9.19	+4.45	MM	-3.43	-1.04
f	+10.13	+1.17	NN	-2.67	+2.39
g	+9.96	-2.24	PP	0.00	0.00
h	+8.66	-5.41			

25-86



Cts	Coordinates		Cts	Coordinates	
	X	y		X	y
A	+1.65	+13.54	a	+10.26	+3.18
B	+6.99	+11.84	b	+11.10	0.00
C	+10.67	+8.56	c	+10.26	-3.18
D	+12.45	+5.77	d	+7.98	-5.61
E	+13.49	+2.36	e	+6.22	-8.56
F	+13.49	-2.36	f	+3.45	-10.77
G	+12.45	-5.77	g	0.00	-10.03
H	+10.67	-8.56	h	-3.45	-10.77
J	+6.99	-11.84	k	-6.22	-8.56
K	+1.65	-13.54	m	-7.98	-5.61
L	-1.65	-13.54	n	-10.26	-3.18
M	-6.99	-11.84	p	-11.10	0.00
N	-10.67	-8.56	q	-10.26	+3.18
P	-12.45	-5.77	r	-7.98	+5.61
R	-13.49	-2.36	s	-6.22	+8.56
S	-13.49	+2.36	t	-3.45	+10.77
T	-12.45	+5.77	u	0.00	+10.03
U	-10.67	+8.56	v	+2.46	+6.73
V	-6.99	+11.84	w	+4.57	0.00
W	-1.65	+13.54	x	+2.46	-6.73
X	+3.45	+10.77	y	-2.46	-6.73
Y	+6.22	+8.56	z	-4.57	0.00
Z	+7.98	+5.61	AA	-2.46	6.73

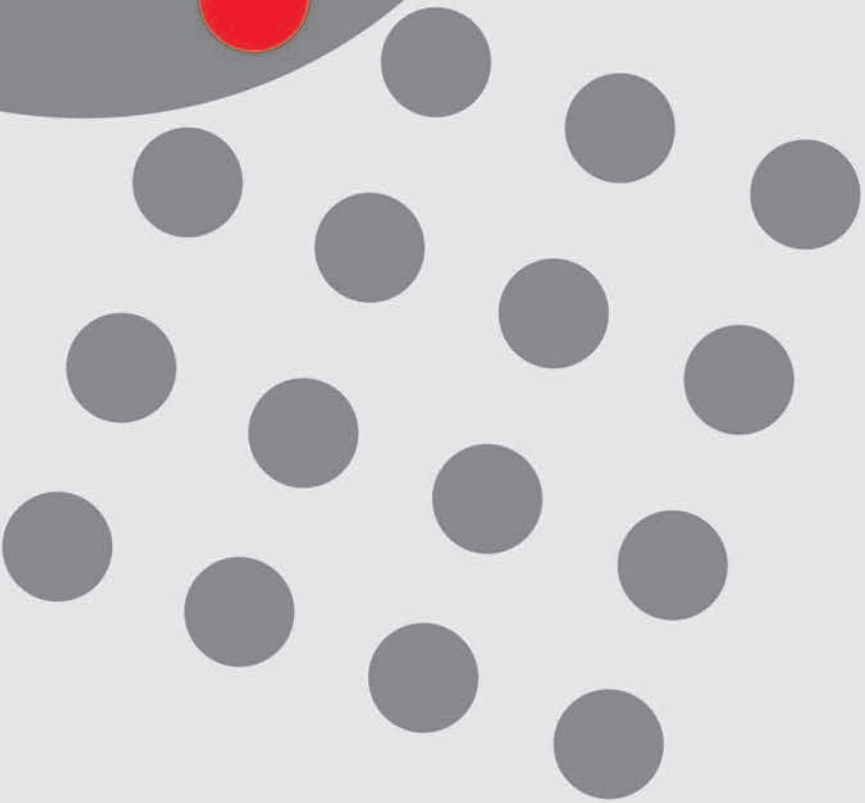
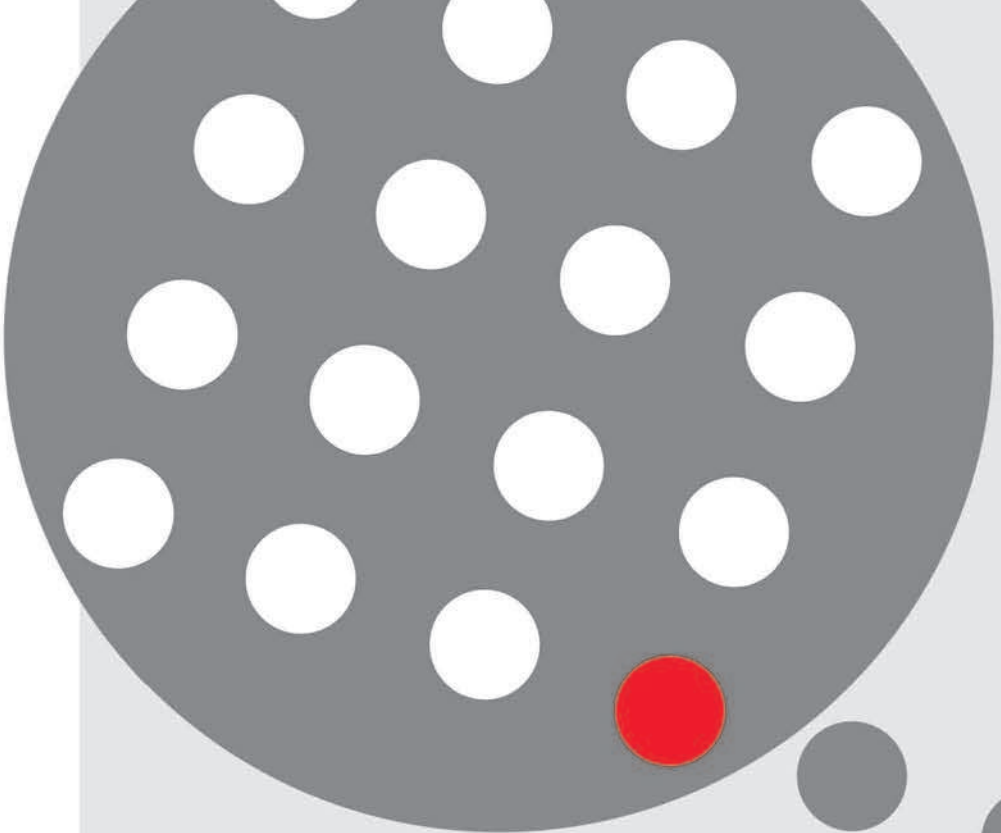

www.souriau.com
contactmilaero@souriau.com

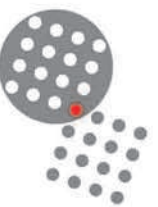

SOURIAU
Connection Technology