

DATA SHEET

RF Engine[®] Model RF100

Part Numbers: RF100PC6 and RF100PD6

Document Revision v1.0



Wireless Technology to Control and Monitor Anything from Anywhere™

© 2011 Synapse, All Rights Reserved
All Synapse products are patented or patent pending
Specifications are subject to change without notice – confirm that data is current
Synapse, the Synapse logo, SNAP, and Portal are all registered trademarks of
Synapse Wireless, Inc.
500 Discovery Drive
Huntsville, Alabama 35806
877-982-7888

Doc # 430144-01B

This Page Intentionally Blank

Table of Contents

1.0 Model RF100 OEM Module Overview	4
1.1 Specifications	5
1.2 Module Pin Definitions	6
1.3 Electrical Characteristics	7
1.4 Mechanical Drawings.....	8
1.5 Board Mounting Configurations.....	9
2.0 Agency Certifications	10
2.1 United States (FCC)	10
2.1.1 OEM Labeling Requirements	10
2.1.2 FCC Notices	11
2.1.3 FCC Approved Antennas.....	11
2.2 Canada (IC).....	12
2.2.1 OEM Labeling Requirements.....	13

1.0 Model RF100 OEM Modules Overview

The Synapse RF Engine™ Model Number RF100 is the all-in-one solution to your embedded wireless control and monitoring needs. Just apply power and you're instantly connected in a SNAP® mesh network. Typical applications include a wireless serial port, sensor monitoring, actuator control, or an intelligent embedded controller. The RF100 offers unmatched performance in a 2.4GHz, IEEE 802.15.4 module. Combined with SNAP firmware, it is *the* off-the-shelf solution to bring your application to market quickly.

SNAP's on-board Python interpreter provides for rapid application development and over-the-air programming. The RF100 is approved as an FCC Part 15 unlicensed modular transmitter. The modules provide up to 16 channels of operation in the ISM 2.4GHz frequency band. The RF100PD6 module contains both a power amplifier for transmission and a low noise amplifier in the receive path for extended range.

This Data Sheet details the RF100PC6 and RF100PD6, which includes:

- SNAP Network Operating System already loaded
- Powerful, reliable wireless connection in 2.4GHz license-free band
- Spread spectrum (DSSS) technology surmounts noisy environments
- Optional, Transmit amplifier (18 dBm) for best-in-class range
- Receive amplifier (10 dBm) standard
- Multiple antenna choices:
 - RF100PD6 – SMA connector (reverse-polarity) for external antenna
 - RF100PC6 – Embedded “F” antenna
- Up to 3-mile range
- Low power modes, down to 1.6 μ A with internal timer running
- Nineteen available general purpose I/Os including:
 - Up to eight analog inputs with 10-bit ADC
 - Two UART ports for control or transparent data
- 60k flash, with 20k free for over-the-air uploaded user applications
- FCC Certified on all 16 channels

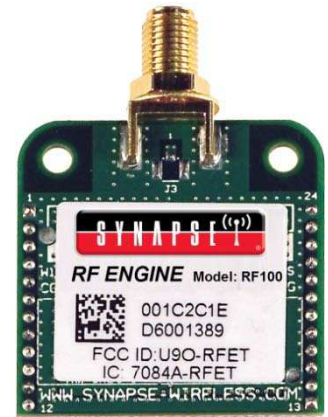

Available with AES-128 encryption for added network security (RF150PC6 and RF150PD6)

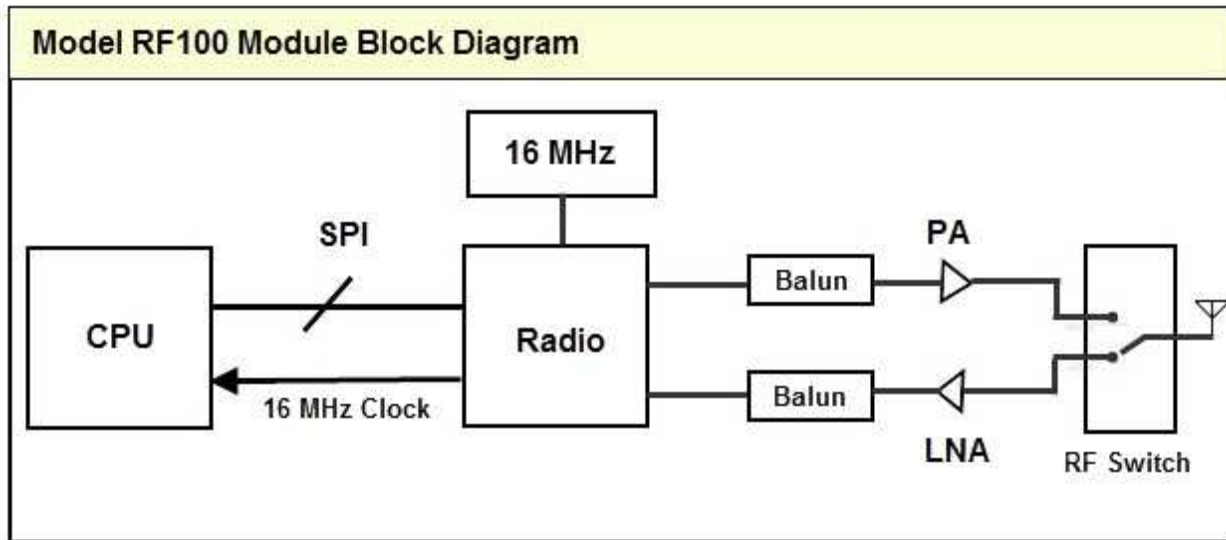

Figure 1.0 Block diagram showing the major subsystems comprising the RF100

1.1 Specifications

Table 1.0 RF100 Specifications		RF100PD6	RF100PC6
Performance	Outdoor LOS Range	Up to 3 miles at 250Kbps	
	Transmit Power Output	18 dBm	
	RF Data Rate	250Kbps	
	Receiver Sensitivity	-102 dBm (1% PER)	
Power Requirements	Supply Voltage	2.7 - 3.4 V	
	Transmit Current (Typ@3.3V)	115mA	
	Idle/Receive Current (Typ@3.3V)	60mA	
	Power-down Current (Typ@3.3V)	1.6uA	
General	Frequency	ISM 2.4 GHz	
	Spreading Method	Direct Sequence (DSSS)	
	Modulation	O-QPSK	
	Dimensions	1.333" x 1.333"	
	Operating Temperature	- 40 to 85 deg C.	
	Antenna Options	External RPSMA	Integrated F-Antenna
Networking	Topology	SNAP	
	Error Handling	Retries and acknowledgement	
	Number of Channels	16	
Available I/O	UARTS with HW Flow Control	2 Ports - 8 total I/O	
	GPIO	20 total; 8 can be analog-in with 10bit ADC	
Agency Approvals	FCC Part 15.247	FCC ID: U90-RFET	
	Industry Canada (IC)	IC: 7084A-RFET	
	CE available as a custom part. Call 1-877-982-7888.		

1.2 Module Pin Definitions

Table 1.2 RF100 Module Pin Assignments		
Pin	Name	Description
1	GND	Power Supply
2	GPIO0_TPM1CH2	GPI/O, or Timer1 Channel 2 (ex. PWM out)
3	GPIO1_KBI0	GPI/O, Keyboard Interrupt
4	GPIO2_KBI1	GPI/O, Keyboard Interrupt
5	GPIO3_RX_UART0	GPI/O, or UART0 Data In
6	GPIO4_TX_UART0	GPI/O, or UART0 Data Out
7	GPIO5_KBI4_CTS0	GPI/O, Keyboard Interrupt, or UART0 CTS output
8	GPIO6_KBI5_RTS0	GPI/O, Keyboard Interrupt, or UART0 RTS input
9	GPIO7_RX_UART1	GPI/O, or UART1 Data In
10	GPIO8_TX_UART1	GPI/O, or UART1 Data Out
11	GPIO9_KBI6_CTS1	GPI/O, Keyboard Interrupt, or UART1 CTS output
12	GPIO10_KBI7_RTS1	GPI/O, Keyboard Interrupt, or UART1 RTS input
13	GPIO11_AD7	GPI/O or Analog In
14	GPIO12_AD6	GPI/O, Analog In, CBUS CDATA, or SPI MOSI
15	GPIO13_AD5	GPI/O, Analog In, CBUS CLK, or SPI CLK
16	GPIO14_AD4	GPI/O, Analog In, CBUS RDATA, or SPI MISO
17	GPIO15_AD3	GPI/O, or Analog In
18	GPIO16_AD2	GPI/O, or Analog In
19	GPIO17_AD1	GPI/O, Analog In, or I2C SDA
20	GPIO18_AD0	GPI/O, Analog In, or I2C SCL
21	VCC	Power Supply
22	PTG0/BKDG	Background Debug Communications
23	RESET*	Module Reset, Active Low
24	GND	Power Supply

1.3 Electrical Characteristics

Table 1.3 RF100 DC Characteristics

Symbol	Parameter	Condition	Min	Typ ₁	Max	Units
V _{CC} ²	Supply Voltage		2.7	3.3	3.6	V
T _{OP}	Operating Temp		-40		85	°C
V _{IH}	Input Hi Voltage	All Digital Inputs	0.70xV _{CC}			V
V _{IL}	Input Low Voltage	All Digital Inputs			0.35xV _{CC}	V
V _{OL}	Output Low Voltage	All drive strengths (2,4,6,8 mA)			0.5	V
V _{OH}	Output High Voltage	All drive strengths (2,4,6,8 mA)	V _{CC} - 0.5			V
I _{LIN}	In Leakage Current	V _{IN} =V _{CC} or V _{SS} , all Pins		0.025	1.0	uA
TX-I _{CC}	Transmit Current	V _{CC} = 3.3V		115	125	mA
RX-I _{CC}	Receive Current			60	68	mA
SHDN-I _{CC}	Sleep Current	V _{CC} = 3.3V		1.6		uA

¹ All typical specifications are measured at 25°C.

² Absolute maximum stress rated voltage for VCC is -0.3 to 3.6. It is recommended that a bulk decoupling capacitor (47 uF tantalum rated at 6.3volts) be located close to the VCC pin 21 of the RF100 connector on host board.

Table 1.4 ADC Electrical Characteristics (Operating)

Symbol	Parameter	Condition	Min	Typical	Max	Unit
V _{REFH}	Voltage Reference, High	Fixed		V _{CC}	V _{CC} +0.3	V
V _{INDC}	Analog input voltage	Single Ended	-0.03		V _{CC} +0.3	V

Table 1.5 ADC Timing/Performance Characteristics

Symbol	Parameter	Condition	Min	Typical	Max	Unit
R _{AS}	Source impedance at input ⁵				10k	kΩ
RES	Conversion Resolution		2.031		3.516	mV
DNL	Differential non-linearity			± 0.5		LSB
INL	Integral non-linearity			0.8		LSB
E _{ZS}	Zero-scale error			1.5		LSB
E _G	Gain error			1		LSB

⁵ Any analog source with a source impedance greater the 3kΩ will increase the sampling time.

1.4 Mechanical Drawings

These drawings in Figure 1.1 show both the version of the module with integrated F-antenna and the version of the module with the SMA connector for use with an external antenna.

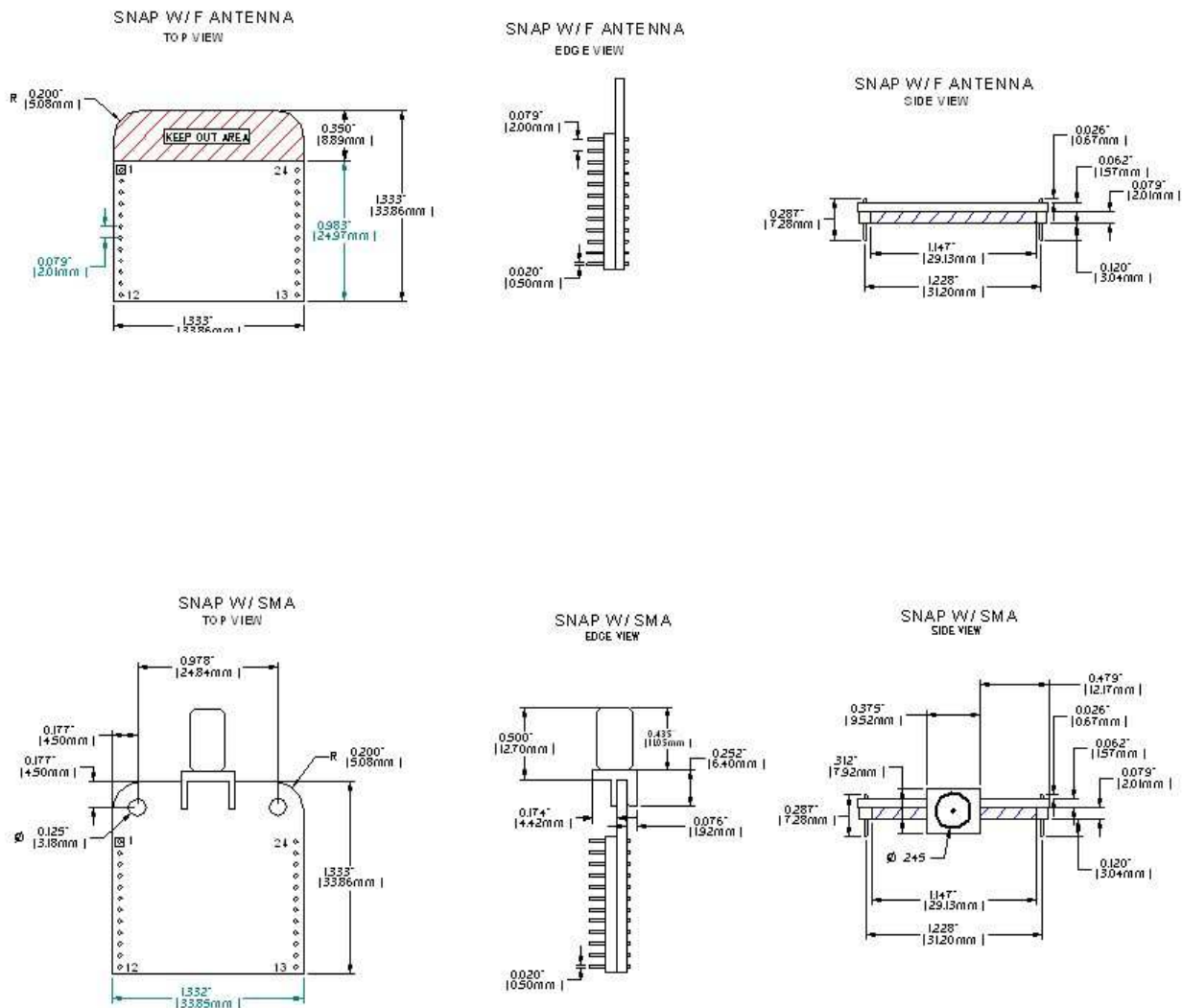

Figure 1.1 Mechanical drawings of the RF100 Modules

1.5 Board Mounting Considerations

The RF100 modules are designed to mount into a receptacle (socket) on the host board. Picture 1.1 shows an RF100PD6 module plugged in to a host board. The receptacle sockets are on standard 2mm centers. Suggested receptacles to be used on the host are:

1)	Thru-hole receptacle	Samtec	MMS-112-01-T-SV
2)	Surface mount receptacle	Samtec	MMS-112-02-T-SV

It is recommended that the mounting holes provided in the module on either side of the SMA connector be used with supporting mounting hardware to hard mount the module to either the host board or to the enclosure to handle the mechanical stresses that can occur when an external antenna is screwed into the SMA. Picture 1.1 shows the RF100PD6 with SMA connector mounted to the host board.

For the module with integrated F-antenna, in order to maximize RF range in the direction behind the module, it is recommended that no components and no metal (either traces or VCC and GND planes) be on any layers of the host board that lies underneath the module in the area designated by the “Keep Out Area” shown in the mechanical drawings of Figure 1.1.

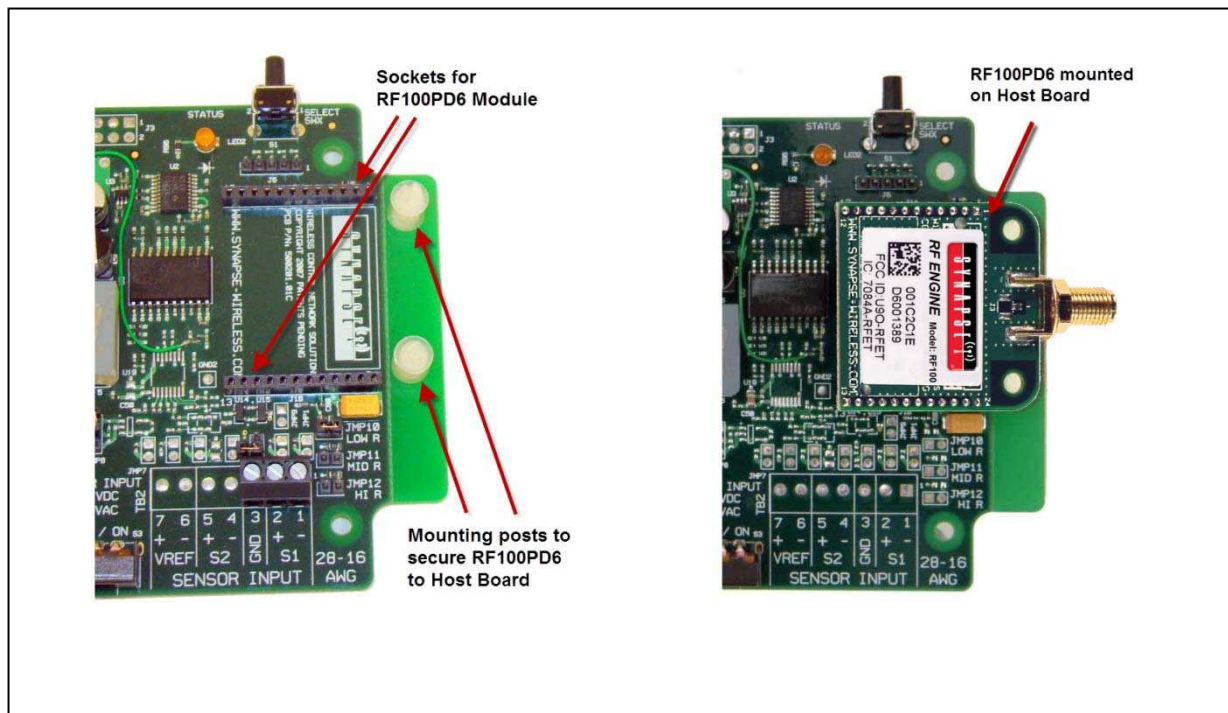

Host Board

RF100PD6 Mounted

Picture 1.1 RF100PD6 Mounted To Host Board

2.0 Agency Certifications

2.1 United States (FCC)

The Model RF100 modules comply with Part 15 of the FCC rules and regulations. Compliance with the labeling requirements, FCC notices and antenna usage guidelines is required. In order to comply with FCC Certification requirements, the Original Equipment Manufacturer (OEM) must fulfill the following requirements.

1. The system integrator must place an exterior label on the outside of the final product housing the RF100 Modules. Figure 2.1 below shows the contents that must be included in this label.
2. RF100 Modules may only be used with the antenna that has been tested and approved for use with the module. Please refer to the antenna table provided in this section.

2.1.1 OEM Labeling Requirements

NOTICE: The OEM must make sure that FCC labeling requirements are met. This includes a clearly visible exterior label on the outside of the final product housing that displays the contents shown in Figure 2.1 below.

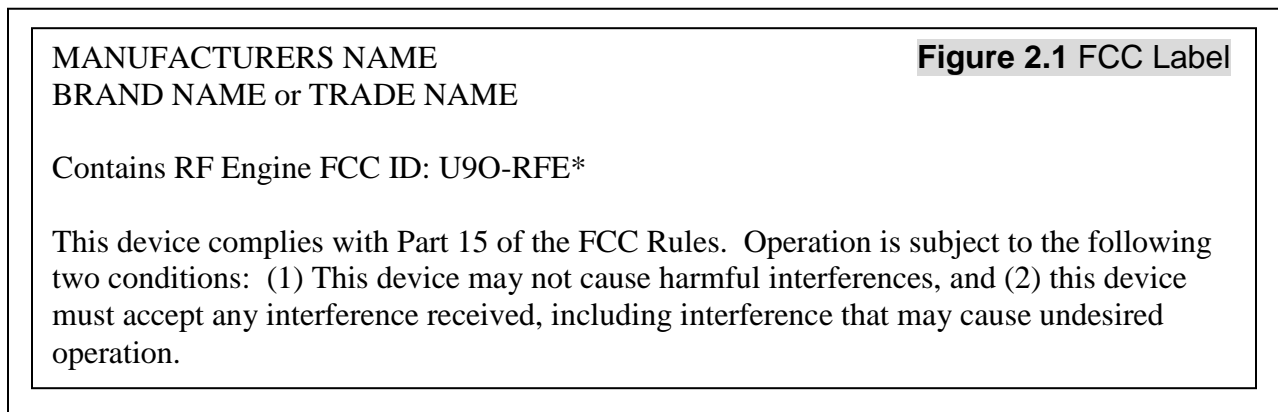

* The FCC ID for the RF Engine *without* external amplifier is “U9O-RFE” which is part number RF100PC1. The FCC ID for the RF Engine *with* external amplifier is “U9O-RFET” which is part number RF100PD1.

2.1.2 FCC Notices

WARNING: The RF100 modules have been tested by the FCC for use with other products without further certification (as per FCC Section 2.1091). Changes or modifications to this device not expressly approved by Synapse Wireless Inc. could void the user's authority to operate the equipment.

NOTICE: OEM's must certify final end product to comply with unintentional radiators (FCC Section 15.107 and 15.109) before declaring compliance of their final product to Part 15 of the FCC Rules.

NOTICE: The RF100 modules have been certified for remote and base radio applications. If the module will be used for portable applications, the device must undergo SAR testing.

This equipment has been tested and found to comply with the limits for a Class B digital device, pursuant to Part 15 of the FCC Rules. These limits are designed to provide reasonable protection against harmful interference in a residential installation. This equipment generates, uses, and can radiate radio frequency energy and, if not installed and used in accordance with the instructions, may cause harmful interference to radio communications. However, there is no guarantee that interference will not occur in a particular installation.

If this equipment does cause harmful interference to radio or television reception, which can be determined by turning the equipment off and on, the user is encouraged to try to correct the interference by one or more of the following measures:

- Reorient or relocate the receiving antenna.
- Increase the separation between the equipment and receiver.
- Connect the equipment into an outlet on a circuit different from that to which the receiver is connected.
- Consult the dealer or an experienced radio/TV technician for help.

2.1.3 FCC Approved Antennas

The RF100 modules are FCC-approved for fixed base station and mobile applications on channels 11 thru 26 of the ISM 2.4GHz frequency band as defined in IEEE 802.15 specifications. The FCC requirement for mobile applications states that the antenna must be mounted at least 20 cm (8 in) from nearby persons.

Notice: To reduce potential radio interference to other users, the antenna type and its gain should be chosen so that the equivalent isotropically radiated power (e.i.r.p.) is not

more than that permitted for successful communication. This module has been designed to operate with the antennas listed below in Table 2.1, and having a maximum gain greater than 5dB are strictly prohibited for use with this device. The required antenna impedance is 50 ohms.

Table 2.1 Approved FCC Antennas				
Part Number	Type	Gain	Application	Min. Separation
AC12000	Dipole (quarter-wave RPSMA)	3.2dBi	Fixed/Mobile	20 cm.
AC12001	Dipole (half-wave RPSMA)	5.0dBi	Fixed/Mobile	20 cm.
AC12002	Dipole (quarter-wave RPSMA)	4.9cBi	Fixed/Mobile	20 cm.
AC12003	Dipole (quarter-wave RPSMA)	2.0dBi	Fixed/Mobile	20 cm.

RF Exposure WARNING: This equipment complies with FCC radiation exposure limits set forth for an uncontrolled environment. This equipment should be installed and operated with minimum distance 20cm between the radiator and your body. This transmitter must not be co-located or operating in conjunction with any other antenna or transmitter.

NOTICE: The preceding statement must be included as a CAUTION statement in OEM product manuals in order to alert users of FCC RF Exposure compliance.

2.2 Canada (IC)

This device complies with Industry Canada license-exempt RSS standard(s). Operation is subject to the following two conditions: (1) this device may not cause interference, and (2) this device must accept any interference, including interference that may cause undesired operation of the device.

Under Industry Canada regulations, this radio transmitter may only operate using an antenna of a type and maximum (or lesser) gain approved for the transmitter by Industry Canada. To reduce potential radio interference to other users, the antenna type and its gain should be so chosen that the equivalent isotropically radiated power (e.i.r.p.) is not more than that necessary for successful communication.

This radio transmitter Model: RF100, IC: 7084A-RF100 has been approved by Industry Canada to operate with the antenna types listed below with the maximum permissible gain and required antenna impedance for each antenna type indicated. Antenna types not included in this list, having a gain greater than the maximum gain indicated for that type, are strictly prohibited for use with this device.

Table 2.2 Approved IC Antennas				
Part Number	Type	Gain	Application	Min. Separation
AC12000	Dipole (quarter-wave RPSMA)	3.2dBi	Fixed/Mobile	20 cm.
AC12001	Dipole (half-wave RPSMA)	5.0dBi	Fixed/Mobile	20 cm.
AC12002	Dipole (quarter-wave RPSMA)	4.9cBi	Fixed/Mobile	20 cm.
AC12003	Dipole (quarter-wave RPSMA)	2.0dBi	Fixed/Mobile	20 cm.

2.2.1 OEM Labeling Requirements

Labeling requirements for Industry Canada are similar to those of the FCC. A clearly visible label on the outside of the final product housing must display the contents shown in Figure 2.2 below.

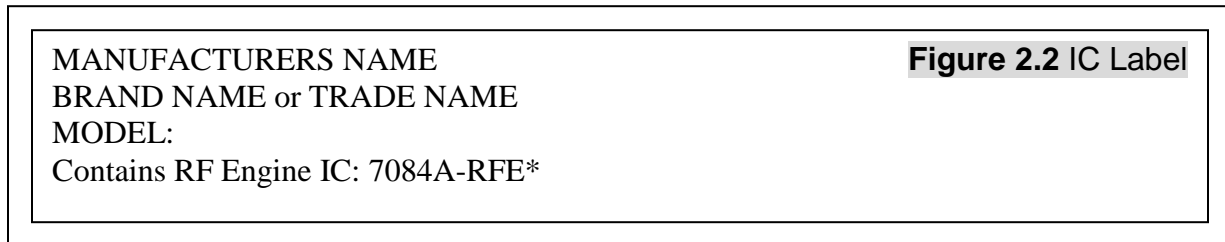

* The IC ID for the RF Engine *without* amp is “7084A-RFE” which is part number RF100PC1. The IC ID for the RF Engine *with* amp is “7084A-RFET” which is part number RF100PD1.

NOTE: The OEM can choose to implement a single label combined for both FCC and IC labeling requirements. If a combined single label is chosen, there must be a clearly visible label on the outside of the final product housing displaying the contents shown in Figure 2.3 below.

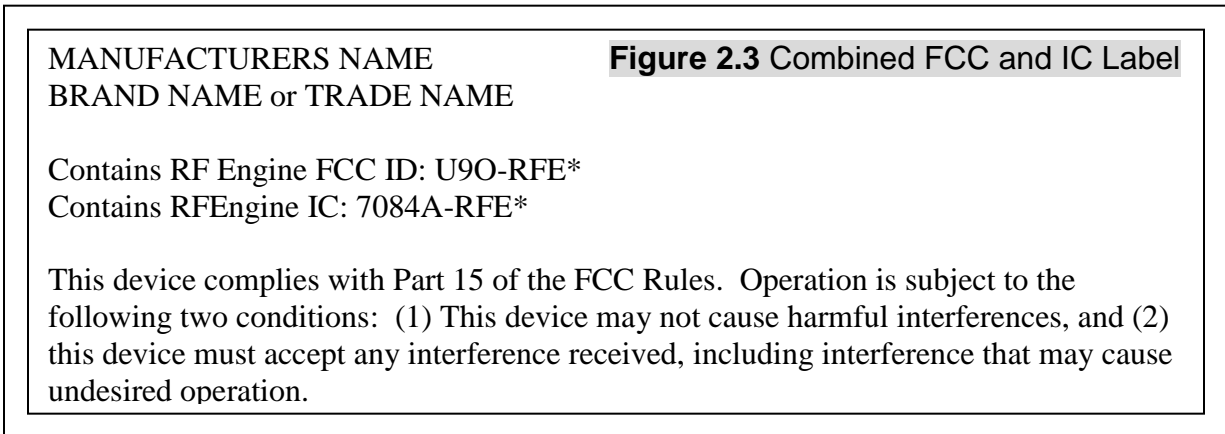

* The FCC ID for the RF Engine *without* amp is “U90-RFE” and the IC ID is “7084A-RFE” which is part number RF100PC1. The FCC ID for the RF Engine *with* amp is “U90-RFET” and the IC ID is “7084ARFET” which is part number RF100PD1.