



## TVH Series • Common Mode EMI Inductors

**TVH Series low cost** toroidal inductors designed to attenuate conductor noise (EMI) in systems

### Features

- SMD design ideal for pick and place compatability
- Manufactured in ISO-9001:2000, TS-16949:2002 and ISO-14001:2004 certified Talema facility
- Meets lead free reflow level J-STD-020C
- Fully RoHS compliant



### Electrical Specifications @ 25°C

Test voltage between windings: 500 Vrms

Operating temperature range: -40°C to +125°C

Climatic Category: IEC68-1 40/125/56

Test frequency: Inductance measured @ 10kHz / 10mV

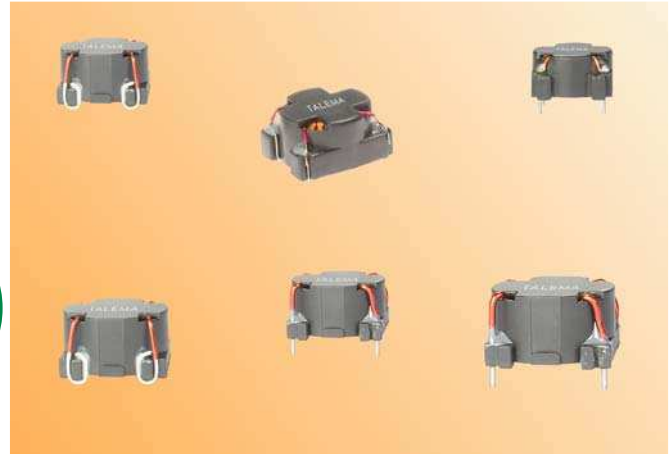

Part Number	Rated RMS Current (Amps)	$L_N$ (mH $\pm 30\%$ )	DCR (mOhm max.)	SRF (MHz)	Vrms	Package Size	
						"S"	"T"
TVH_-3.6-102	3.60	1.0	50	4	1500	SC5	TC5
TVH_-1.5-102	1.5	1.0	60	2	1500	SC3	TC3
TVH_-2.5-302	2.50	3.0	80	2.2	1500	SC5	TC5
TVH_-1.0-103	1.00	10.0	450	0.5	1500	SC3	TC3
TVH_-0.5-223	0.50	22.0	850	0.3	1500	SC3	TC3

**Note:** When ordering, add "S" or "T" to the basic part number to denote preferred mounting style. Example: TVHS-1.0-223 for SMD or TVHT-1.0-223 for through hole.

### Dimensions

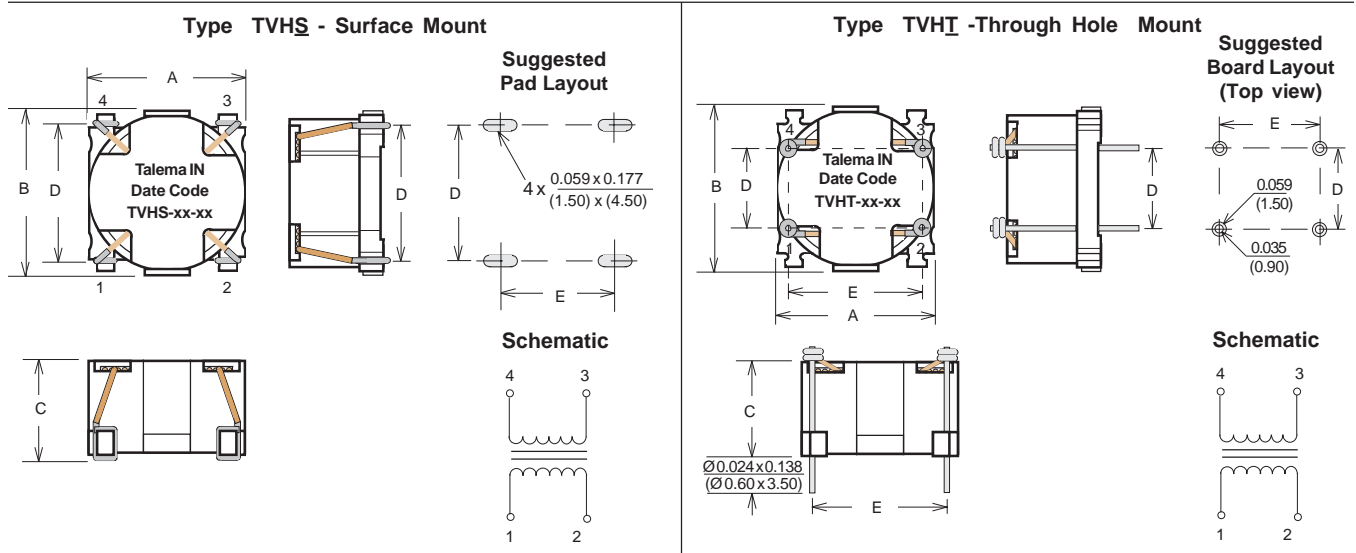

Mounting Style	Size Code	Dimensions - Inches $\pm 0.010$ (mm $\pm 0.25$ )				
		A	B	C	D	E
"S" SMD	SC3	0.551 (14.00)	0.630 (16.00)	0.350 max. (8.90 max.)	0.530 (13.46)	0.340 (8.64)
	SC5	0.662 (16.82)	0.760 (19.31)	0.390 max. (9.90 max.)	0.660 (16.76)	0.445 (11.30)
"T" TH	TC3	0.551 (14.00)	0.630 (16.00)	0.327 max. (8.30 max.)	0.500 (12.70)	0.400 (10.16)
	TC5	0.662 (16.82)	0.760 (19.31)	0.362 max. (9.20 max.)	0.500 (12.70)	0.500 (12.70)