

M392B1G70BH0
M392B1G73BH0
M392B2G70BM0
M392B2G73BM0
M392B4G70BE0

240pin VLP Registered DIMM based on 4Gb B-die

1.35V

78FBGA with Lead-Free & Halogen-Free
(RoHS compliant)

datasheet

SAMSUNG ELECTRONICS RESERVES THE RIGHT TO CHANGE PRODUCTS, INFORMATION AND SPECIFICATIONS WITHOUT NOTICE.

Products and specifications discussed herein are for reference purposes only. All information discussed herein is provided on an "AS IS" basis, without warranties of any kind.

This document and all information discussed herein remain the sole and exclusive property of Samsung Electronics. No license of any patent, copyright, mask work, trademark or any other intellectual property right is granted by one party to the other party under this document, by implication, estoppel or otherwise.

Samsung products are not intended for use in life support, critical care, medical, safety equipment, or similar applications where product failure could result in loss of life or personal or physical harm, or any military or defense application, or any governmental procurement to which special terms or provisions may apply.

For updates or additional information about Samsung products, contact your nearest Samsung office.

All brand names, trademarks and registered trademarks belong to their respective owners.

© 2011 Samsung Electronics Co., Ltd. All rights reserved.

Revision History

<u>Revision No.</u>	<u>History</u>	<u>Draft Date</u>	<u>Remark</u>	<u>Editor</u>
1.0	- First SPEC. Release	Jun. 2011	-	J.Y.Lee
1.01	- Corrected Tpyo.	Jul. 2011	-	J.Y.Lee
1.1	- Changed input/output capacitance for 1333/1600Mbps of 1.35V	Aug. 2011	-	J.Y.Lee
1.2	- Changed input/output capacitance on pgae 36 - Changed 1Rx4, 2Rx4, 4Rx8 and 4Rx4 module block diagram	Nov. 2011	-	J.Y.Lee

Table Of Contents

240pin VLP Registered DIMM based on 4Gb B-die

1. DDR3L VLP Registered DIMM Ordering Information	5
2. Key Features.....	5
3. Address Configuration	5
4. Registered DIMM Pin Configurations (Front side/Back side).....	6
5. Pin Description	7
6. ON DIMM Thermal Sensor	7
7. Input/Output Functional Description.....	8
8. Pinout Comparison Based On Module Type.....	9
9. Registering Clock Driver Specification.....	10
9.1 Timing & Capacitance values	10
9.2 Clock driver Characteristics	10
10. Function Block Diagram:.....	11
10.1 8GB, 1Gx72 Module (Populated as 1 rank of x4 DDR3 SDRAMs)	11
10.2 8GB, 1Gx72 Module (Populated as 2 ranks of x8 DDR3 SDRAMs)	12
10.3 16GB, 2Gx72 Module (Populated as 2 ranks of x4 DDR3 SDRAMs)	13
10.4 16GB, 2Gx72 Module (Populated as 4 ranks of x8 DDR3 SDRAMs)	14
10.5 32GB, 4Gx72 Module (Populated as 4 ranks of x4 DDR3 SDRAMs)	17
11. Absolute Maximum Ratings	20
11.1 Absolute Maximum DC Ratings.....	20
11.2 DRAM Component Operating Temperature Range	20
12. AC & DC Operating Conditions.....	20
12.1 Recommended DC Operating Conditions	20
13. AC & DC Input Measurement Levels	21
13.1 AC & DC Logic Input Levels for Single-ended Signals	21
13.2 V_{REF} Tolerances.....	23
13.3 AC and DC Logic Input Levels for Differential Signals	24
13.3.1. Differential Signals Definition	24
13.3.2. Differential Swing Requirement for Clock (CK - \overline{CK}) and Strobe (DQS - \overline{DQS})	24
13.3.3. Single-ended Requirements for Differential Signals	26
13.3.4. Differential Input Cross Point Voltage	27
13.4 Slew Rate Definition for Single Ended Input Signals.....	28
13.5 Slew rate definition for Differential Input Signals	28
14. AC & DC Output Measurement Levels	28
14.1 Single Ended AC and DC Output Levels.....	28
14.2 Differential AC and DC Output Levels	28
14.3 Single-ended Output Slew Rate	29
14.4 Differential Output Slew Rate	30
15. IDD specification definition.....	31
16. IDD SPEC Table	33
17. Input/Output Capacitance	36
18. Electrical Characteristics and AC timing	37
18.1 Refresh Parameters by Device Density.....	37
18.2 Speed Bins and CL, tRCD, tRP, tRC and tRAS for Corresponding Bin	37
18.3 Speed Bins and CL, tRCD, tRP, tRC and tRAS for Corresponding Bin	37
18.3.1. Speed Bin Table Notes	40
19. Timing Parameters by Speed Grade	41
19.1 Jitter Notes	44
19.2 Timing Parameter Notes.....	45
20. Physical Dimensions.....	46
20.1 1Gb4 based 1Gx72 Module (1 Rank) - M392B1G70BH0.....	46
20.1.1. x72 DIMM, populated as one physical rank of x4 DDR3 SDRAMs.....	46

20.2 512Mbx8 based 1Gx72 Module (2 Ranks) - M392B1G73BH0..... 47
20.2.1. x72 DIMM, populated as two physical ranks of x8 DDR3 SDRAMs 47
20.3 2Gbx4(DDP) based 2Gx72 Module (2 Ranks) - M392B2G70BM0 48
20.3.1. x72 DIMM, populated as two physical ranks of x4 DDR3 SDRAMs 48
20.4 1Gbx8(DDP) based 2Gx72 Module (4 Ranks) - M392B2G73BM0 49
20.4.1. x72 DIMM, populated as four physical ranks of x8 DDR3 SDRAMs..... 49
20.4.2. 16GB Heat Spreader Design Guide..... 50
20.5 4Gbx4(QDP) based 4Gx72 Module (4 Ranks) - M392B4G70BE0 52
20.5.1. x72 DIMM, populated as four physical ranks of x4 DDR3 SDRAMs..... 52
20.5.2. 32GB Heat Spreader Design Guide..... 53



1. DDR3L VLP Registered DIMM Ordering Information

Part Number ²	Density	Organization	Component Composition	Number of Rank	Height
M392B1G70BH0-YF8/H9/K0	8GB	1Gx72	1Gx4(K4B4G0446B-HY##)*18	1	18.75mm
M392B1G73BH0-YF8/H9/K0	8GB	1Gx72	512Mx8(K4B4G0846B-HY##)*18	2	18.75mm
M392B2G70BM0-YF8/H9/K0	16GB	2Gx72	DDP 2Gx4(K4B8G0446B-MY##)*18	2	18.75mm
M392B2G73BM0-YF8/H9	16GB	2Gx72	DDP 1Gx8(K4B8G0846B-MY##)*18	4	18.75mm
M392B4G70BE0-YF8/H9	32GB	4Gx72	QDP 4Gx4(K4BAG0446B-EY##)*18	4	18.75mm

NOTE :

- "##" - F8/H9/K0
- F8(1066Mbps 7-7-7) / H9(1333Mbps 9-9-9) / K0(1600Mbps 11-11-11)
 - DDR3-1600(11-11-11) is backward compatible to DDR3-1333(9-9-9), DDR3-1066(7-7-7)
 - DDR3-1333(9-9-9) is backward compatible to DDR3-1066(7-7-7)

2. Key Features

Speed	DDR3-800	DDR3-1066	DDR3-1333	DDR3-1600	Unit
	6-6-6	7-7-7	9-9-9	11-11-11	
tCK(min)	2.5	1.875	1.5	1.25	ns
CAS Latency	6	7	9	11	nCK
tRCD(min)	15	13.125	13.5	13.75	ns
tRP(min)	15	13.125	13.5	13.75	ns
tRAS(min)	37.5	37.5	36	35	ns
tRC(min)	52.5	50.625	49.5	48.75	ns

- JEDEC standard 1.35V(1.28V~1.45V) & 1.5V(1.425V~1.575V) Power Supply
- $V_{DDQ} = 1.35V(1.28V\sim 1.45V) \text{ \& } 1.5V(1.425V\sim 1.575V)$
- 400MHz f_{CK} for 800Mb/sec/pin, 533MHz f_{CK} for 1066Mb/sec/pin, 667MHz f_{CK} for 1333Mb/sec/pin, 800MHz f_{CK} for 1600Mb/sec/pin
- 8 independent internal bank
- Programmable CAS Latency: 6,7,8,9,10,11
- Programmable Additive Latency(Posted CAS) : 0, CL - 2, or CL - 1 clock
- Programmable CAS Write Latency(CWL) = 5(DDR3-800), 6(DDR3-1066), 7(DDR3-1333) and 8(DDR3-1600)
- 8-bit pre-fetch
- Burst Length: 8 (Interleave without any limit, sequential with starting address "000" only), 4 with tCCD = 4 which does not allow seamless read or write [either On the fly using A12 or MRS]
- Bi-directional Differential Data Strobe
- Internal(self) calibration : Internal self calibration through ZQ pin (RZQ : 240 ohm \pm 1%)
- On Die Termination using ODT pin
- Average Refresh Period 7.8us at lower then $T_{CASE} 85^{\circ}C$, 3.9us at $85^{\circ}C < T_{CASE} \leq 95^{\circ}C$
- Asynchronous Reset

3. Address Configuration

Organization	Row Address	Column Address	Bank Address	Auto Precharge
1Gx4(4Gb) based Module	A0-A15	A0-A9, A11	BA0-BA2	A10/AP
512Mx8(4Gb) based Module	A0-A15	A0-A9	BA0-BA2	A10/AP
2Gx4(8Gb DDP) based Module	A0-A15	A0-A9, A11	BA0-BA2	A10/AP
1Gx8(8Gb DDP) based Module	A0-A15	A0-A9	BA0-BA2	A10/AP
4Gx4(16Gb QDP) based Module	A0-A15	A0-A9, A11	BA0-BA2	A10/AP

4. Registered DIMM Pin Configurations (Front side/Back side)

Pin	Front	Pin	Back	Pin	Front	Pin	Back	Pin	Front	Pin	Back
1	V _{REFDQ}	121	V _{SS}	42	DQS8	162	NC,DQS17 ,TDQS17	82	DQ33	202	V _{SS}
2	V _{SS}	122	DQ4	43	DQS8	163	V _{SS}	83	V _{SS}	203	DM4,DQS13 ,TDQS13
3	DQ0	123	DQ5	44	V _{SS}	164	CB6,NC	84	DQS4	204	NC,DQS13 ,TDQS13
4	DQ1	124	V _{SS}	45	CB2,NC	165	CB7,NC	85	DQS4	205	V _{SS}
5	V _{SS}	125	DM0,DQS9 ,TDQS9	46	CB3,NC	166	V _{SS}	86	V _{SS}	206	DQ38
6	DQS0	126	NC,DQS9 ,TDQS9	47	V _{SS}	167	NC(TEST)	87	DQ34	207	DQ39
7	DQS0	127	V _{SS}	48	V _{TT} , NC	168	RESET	88	DQ35	208	V _{SS}
8	V _{SS}	128	DQ6	KEY				89	V _{SS}	209	DQ44
9	DQ2	129	DQ7	49	V _{TT} , NC	169	CKE1, NC	90	DQ40	210	DQ45
10	DQ3	130	V _{SS}	50	CKE0	170	V _{DD}	91	DQ41	211	V _{SS}
11	V _{SS}	131	DQ12	51	V _{DD}	171	A15	92	V _{SS}	212	DM5,DQS14 ,TDQS14
12	DQ8	132	DQ13	52	BA2	172	A14	93	DQS5	213	NC,DQS14 ,TDQS14
13	DQ9	133	V _{SS}	53	Err_Out/NC	173	V _{DD}	94	DQS5	214	V _{SS}
14	V _{SS}	134	DM1,DQS10 ,TDQS10	54	V _{DD}	174	A12/BC	95	V _{SS}	215	DQ46
15	DQS1	135	NC,DQS10 ,TDQS10	55	A11	175	A9	96	DQ42	216	DQ47
16	DQS1	136	V _{SS}	56	A7	176	V _{DD}	97	DQ43	217	V _{SS}
17	V _{SS}	137	DQ14	57	V _{DD}	177	A8	98	V _{SS}	218	DQ52
18	DQ10	138	DQ15	58	A5	178	A6	99	DQ48	219	DQ53
19	DQ11	139	V _{SS}	59	A4	179	V _{DD}	100	DQ49	220	V _{SS}
20	V _{SS}	140	DQ20	60	V _{DD}	180	A3	101	V _{SS}	221	DM6,DQS15 ,TDQS15
21	DQ16	141	DQ21	61	A2	181	A1	102	DQS6	222	NC,DQS15 ,TDQS15
22	DQ17	142	V _{SS}	62	V _{DD}	182	V _{DD}	103	DQ56	223	V _{SS}
23	V _{SS}	143	DM2,DQS11 ,TDQS11	63	NC, CK1	183	V _{DD}	104	V _{SS}	224	DQ54
24	DQS2	144	NC,DQS11 ,TDQS11	64	NC, CK1	184	CK0	105	DQ50	225	DQ55
25	DQS2	145	V _{SS}	65	V _{DD}	185	CK0	106	DQ51	226	V _{SS}
26	V _{SS}	146	DQ22	66	V _{DD}	186	V _{DD}	107	V _{SS}	227	DQ60
27	DQ18	147	DQ23	67	V _{REFCA}	187	EVENT,NC	108	DQ56	228	DQ61
28	DQ19	148	V _{SS}	68	NC/Par_In	188	A0	109	DQ57	229	V _{SS}
29	V _{SS}	149	DQ28	69	V _{DD}	189	V _{DD}	110	V _{SS}	230	DM7/DQS16 TDQS16
30	DQ24	150	DQ29	70	A10/AP	190	BA1	111	DQS7	231	DM7/DQS16 TDQS16
31	DQ25	151	V _{SS}	71	BA0	191	V _{DD}	112	DQS7	232	V _{SS}
32	V _{SS}	152	DM3,DQS12 ,TDQS12	72	V _{DD}	192	RAS	113	V _{SS}	233	DQ62
33	DQS3	153	NC,DQS12 ,TDQS12	73	WE	193	S0	114	DQ58	234	DQ63
34	DQS3	154	V _{SS}	74	CAS	194	V _{DD}	115	DQ59	235	V _{SS}
35	V _{SS}	155	DQ30	75	V _{DD}	195	ODT0	116	V _{SS}	236	V _{DDSPD}
36	DQ26	156	DQ31	76	S1,NC	196	A13	117	SA0	237	SA1
37	DQ27	157	V _{SS}	77	ODT1,NC	197	V _{DD}	118	SCL	238	SDA
38	V _{SS}	158	CB4,NC	78	V _{DD}	198	S3,NC	119	SA2	239	V _{SS}
39	CB0,NC	159	CB5,NC	79	S2,NC	199	V _{SS}	120	V _{TT}	240	V _{TT}
40	CB1,NC	160	V _{SS}	80	V _{SS}	200	DQ36				
41	V _{SS}	161	DM8,DQS17 TDQS17,NC	81	DQ32	201	DQ37				

NOTE : NC = No internal Connection

SAMSUNG ELECTRONICS CO., Ltd. reserves the right to change products and specifications without notice.

5. Pin Description

Pin Name	Description	Number	Pin Name	Description	Number
CK0	Clock Input, positive line	1	ODT[1:0]	On Die Termination Inputs	2
$\overline{CK0}$	Clock Input, negative line	1	DQ[63:0]	Data Input/Output	64
CKE[1:0]	Clock Enables	2	CB[7:0]	Data check bits Input/Output	8
\overline{RAS}	Row Address Strobe	1	DQS[8:0]	Data strobes	9
\overline{CAS}	Column Address Strobe	1	\overline{DQS} [8:0]	Data strobes, negative line	9
\overline{WE}	Write Enable	1	DM[8:0]/ DQS[17:9] TDQS[17:9]	Data Masks/ Data strobes, Termination data strobes	9
\overline{S} [3:0]	Chip Selects	4	\overline{DQS} [17:9] TDQS[17:9]	Data strobes, negative line, Termination data strobes	9
A[9:0],A11, A[15:13]	Address Inputs	2\14	RFU	Reserved for Future Use	2
A10/AP	Address Input/Autoprecharge	1	\overline{EVENT}	Reserved for optional hardware temperature sensing	1
A12/ \overline{BC}	Address Input/Burst chop	1	TEST	Memory bus test toll (Not Connected and Not Usable on DIMMs)	1
BA[2:0]	SDRAM Bank Addresses	3	\overline{RESET}	Register and SDRAM control pin	1
SCL	Serial Presence Detect (SPD) Clock Input	1	V _{DD}	Power Supply	22
SDA	SPD Data Input/Output	1	V _{SS}	Ground	59
SA[2:0]	SPD Address Inputs	3	V _{REFDQ}	Reference Voltage for DQ	1
Par_In	Parity bit for the Address and Control bus	1	V _{REFCA}	Reference Voltage for CA	1
$\overline{Err_Out}$	Parity error found on the Address and Control bus	1	V _{TT}	Termination Voltage	4
			V _{DDSPD}	SPD Power	1
				Total	240

NOTE :
*The V_{DD} and V_{DDQ} pins are tied common to a single power-plane on these designs.

6. ON DIMM Thermal Sensor

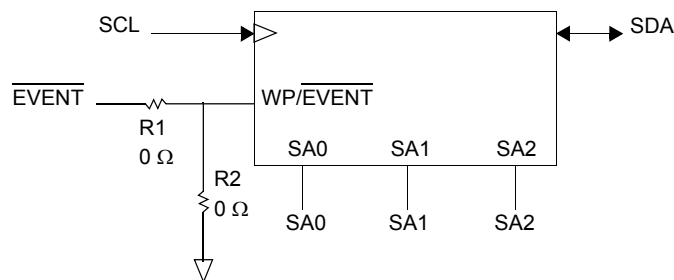

NOTE : 1. All Samsung RDIMM support Thermal sensor on DIMM
2. When the SPD and the thermal sensor are placed on the module, R1 is placed but R2 is not.
When only the SPD is placed on the module, R2 is placed but R1 is not.

[Table 1] Temperature Sensor Characteristics

Grade	Range	Temperature Sensor Accuracy			Units	NOTE
		Min.	Typ.	Max.		
B	75 < Ta < 95	-	+/- 0.5	+/- 1.0	°C	-
	40 < Ta < 125	-	+/- 1.0	+/- 2.0		-
	-20 < Ta < 125	-	+/- 2.0	+/- 3.0		-
Resolution		0.25			°C /LSB	-

7. Input/Output Functional Description

Symbol	Type	Polarity	Function
CK0	Input	Positive Edge	Positive line of the differential pair of system clock inputs that drives input to the on-DIMM Clock Driver.
$\overline{\text{CK0}}$	Input	Negative Edge	Negative line of the differential pair of system clock inputs that drives the input to the on-DIMM Clock Driver.
CKE[1:0]	Input	Active High	CKE HIGH activates, and CKE LOW deactivates internal clock signals, and device input buffers and output drivers of the SDRAMs. Taking CKE LOW provides PRECHARGE POWER-DOWN and SELF REFRESH operation (all banks idle), or ACTIVE POWER DOWN (row ACTIVE in any bank)
$\overline{\text{S}}[3:0]$	Input	Active Low	Enables the associated SDRAM command decoder when low and disables decoder when high. When decoder is disabled, new commands are ignored and previous operations continue. These input signals also disable all outputs (except CKE and ODT) of the register(s) on the DIMM when both inputs are high. When both S[1:0] are high, all register outputs (except CKE, ODT and Chip select) remain in the previous state. For modules supporting 4 ranks, S[3:2] operate similarly to S[1:0] for a second set of register outputs.
ODT[1:0]	Input	Active High	On-Die Termination control signals
$\overline{\text{RAS}}$, $\overline{\text{CAS}}$, $\overline{\text{WE}}$	Input	Active Low	When sampled at the positive rising edge of the clock, $\overline{\text{CAS}}$, $\overline{\text{RAS}}$, and $\overline{\text{WE}}$ define the operation to be executed by the SDRAM.
V_{REFDQ}	Supply		Reference voltage for DQ0-DQ63 and CB0-CB7
V_{REFCA}	Supply		Reference voltage for A0-A15, BA0-BA2, $\overline{\text{RAS}}$, $\overline{\text{CAS}}$, $\overline{\text{WE}}$, $\overline{\text{S0}}$, $\overline{\text{S1}}$, CKE0, CKE1, Par_In, ODT0 and ODT1.
BA[2:0]	Input		Selects which SDRAM bank of eight is activated. BA0 - BA2 define to which bank an Active, Read, Write or Precharge command is being applied. Bank address also determines mode register is to be accessed during an MRS cycle.
A[15:13, 12/BC, 11, 10/AP, 9:0]	Input		Provides the row address for Active commands and the column address and Auto Precharge bit for Read/Write commands to select one location out of the memory array in the respective bank. A10 is sampled during a Precharge command to determine whether the Precharge applies to one bank (A10 LOW) or all banks (A10 HIGH). If only one bank is to be precharged, the bank is selected by BA. A12 is also utilized for BL 4/8 identification for "BL on the fly" during CAS command. The address inputs also provide the op-code during Mode Register Set commands.
DQ[63:0], CB[7:0]	I/O		Data and Check Bit Input/Output pins
DM[8:0]			Active High Masks write data when high, issued concurrently with input data. V_{DD} , V_{SS} Supply Power and ground for the DDR SDRAM input buffers and core logic. V_{TT} Supply Termination Voltage for Address/Command/Control/Clock nets.
DQS[17:0]	I/O		Positive Edge Positive line of the differential data strobe for input and output data.
$\overline{\text{DQS}}$ [17:0]	I/O		Negative Edge Negative line of the differential data strobe for input and output data.
$\overline{\text{TDQS}}$ [17:9], $\overline{\text{TDQS}}$ [17:9]	OUT		TDQS/TDQS is applicable for X8 DRAMs only. When enabled via Mode Register A11=1 in MR1, DRAM will enable the same termination resistance function on TDQS/TDQS that is applied to DQS/DQS. When disabled via mode register A11=0 in MR1, DM/TDQS will provide the data mask function and TDQS is not used. X4/X16 DRAMs must disable the TDQS function via mode register A11=0 in MR1
SA[2:0]	IN		These signals are tied at the system planar to either V_{SS} or V_{DDSPD} to configure the serial SPD EEPROM address range.
SDA	I/O		This bidirectional pin is used to transfer data into or out of the SPD EEPROM. A resistor must be connected from the SDA bus line to V_{DDSPD} on the system planar to act as a pull-up.
SCL	IN		This signal is used to clock data into and out of the SPD EEPROM. A resistor may be connected from the SCL bus line to V_{DDSPD} on the system planar to act as a pull-up.
$\overline{\text{EVENT}}$	OUT (open drain)	Active Low	This signal indicates that a thermal event has been detected in the thermal sensing device. The system should guarantee the electrical level requirement is met for the EVENT pin on TS/SPD part.
V_{DDSPD}	Supply		Serial EEPROM positive power supply wired to a separate power pin at the connector which supports from 3.0 Volt to 3.6 Volt (nominal 3.3V) operation.
$\overline{\text{RESET}}$	IN		The RESET pin is connected to the RESET pin on the register and to the RESET pin on the DRAM. When low, all register outputs will be driven low and the Clock Driver clocks to the DRAMs and register(s) will be set to low level (the Clock Driver will remain synchronized with the input clock)
Par_In	IN		Parity bit for the Address and Control bus. ("1" : Odd, "0" : Even)
$\overline{\text{Err_Out}}$	OUT (open drain)		Parity error detected on the Address and Control bus. A resistor may be connected from $\overline{\text{Err_Out}}$ bus line to V_{DD} on the system planar to act as a pull up.
TEST			Used by memory bus analysis tools (unused (NC) on memory DIMMs)

8. Pinout Comparison Based On Module Type

Pin	RDIMM		UDIMM	
	Signal	NOTE	Signal	NOTE
48, 49	V_{TT}	Additional connection for Termination Voltage for Address/Command/Control/Clock nets.	NC	Not used on UDIMMs
120, 240	V_{TT}	Termination Voltage for Address/Command/Control/Clock nets.	V_{TT}	Termination Voltage for Address/Command/Control/Clock nets.
53	Err_Out	Connected to the register on all RDIMMs NC Not used on UDIMMs	NC	NC Not used on UDIMMs
63	NC	Not used on RDIMMs	CK1	Used for 2 rank UDIMMs, not used on single-rank UDIMMs, but terminated
64	NC		$\overline{CK1}$	
68	Par_In	Connected to the register on all RDIMMs	NC	Not used on RDIMMs
76	$\overline{S1}$	Connected to the register on all RDIMMs	$\overline{S1}$	Used for dual-rank UDIMMs, not connected on single-rank UDIMMs
77	ODT1, NC	Connected to the register on dual- and quadrank RDIMMs; NC on single-rank RDIMMs	ODT1,NC	Used for dual-rank UDIMMs, not connected on single-rank UDIMMs
79	$\overline{S2}$, NC	Connected to the register on quad-rank RDIMMs, not connected on single or dual rank RDIMMs	NC	Not used on UDIMMs
167	NC	TEST input used only on bus analysis probes	NC	TEST input used only on bus analysis probes
169	CKE1	Connected to the register on dual- and quadrank RDIMMs; NC on single-rank RDIMMs	CKE1, NC	Used for dual-rank UDIMMs, not connected on single-rank UDIMMs
171	A15	Connected to the register on all RDIMMs	A15, NC	Depending on device density, may not be connected to SDRAMs on UDIMMs. However, these signals are terminated on UDIMMs. A15 not routed on some RCs
172	A14		A14	
196	A13		A13	
198	$\overline{S3}$, NC	Connected to the register on quad-rank RDIMMs, not connected on single-or dual-rank RDIMMs	NC	Not used on UDIMMs
39, 40, 45, 46, 158, 159, 164, 165	CBn	Used on all RDIMMs; (n = 0...7)	NC, CBn	Used on x72 UDIMMs, (n = 0...7); not used on x64 UDIMMs
125, 134, 143, 152, 161, 203, 212, 221, 230	DQSn, TDQSn	Connected to DQS on x4 SDRAMs, TDQS on x8 SDRAMs on RDIMMs; (n = 9...17)	DMn	Connected to DM on x8 DRAMs, UDM or LDM on x16 DRAMs on UDIMMs; (n = 0...8)
126, 135, 144, 153, 162, 204, 213, 222, 231	\overline{DQSn} , \overline{TDQSn}	Connected to \overline{DQS} on x4 DRAMs, \overline{TDQS} on x8 SDRAMs on RDIMMs; (n=9...17)	NC	Not used on UDIMMs
187	\overline{EVENT} NC	Connected to optional thermal sensing component. NC on Modules without a thermal sensing component.	NC	Not used on UDIMMs

NOTE : NC = No internal Connection

9. Registering Clock Driver Specification

9.1 Timing & Capacitance values

Symbol	Parameter	Conditions	T _C = TBD V _{DD} = 1.35V(1.28V~1.45V) & 1.5V(1.425~1.575V)		Units	Notes
			Min	Max		
f _{clock}	Input Clock Frequency	application frequency	300	670	MHz	
t _{CH} /t _{CL}	Pulse duration, CK, $\overline{\text{CK}}$ HIGH or LOW		0.4	-	t _{CK}	
t _{ACT}	Inputs active time ⁴ before RESET is taken HIGH	DCKE0/1 = LOW and DCS0/1 = HIGH	8	-	t _{CK}	
t _{SU}	Setup time	Input valid before CK/ $\overline{\text{CK}}$	100	-	ps	
t _H	Hold time	Input to remain Valid after CK/ CK	175	-		
t _{PDM}	Propagation delay, single-bit switching	CK/ $\overline{\text{CK}}$ to output	0.65	1.0	ns	
t _{DIS}	output disable time(1/2-Clock pre-launch)	CK/ $\overline{\text{CK}}$ to output float	0.5	-	t _{CK}	
	output disable time(3/4-Clock pre-launch)		0.25	-		
t _{EN}	output enable time(1/2-Clock pre-launch)	CK/ $\overline{\text{CK}}$ to output driving	-	0.5	t _{CK}	
	output enable time(3/4-Clock pre-launch)		-	0.25		
C _{IN} (DATA)	Data Input Capacitance		1.5	2.5	pF	
C _{IN} (CLOCK)	Data Input Capacitance		2	3		
C _{IN} (RST)	Reset Input Capacitance		-	3		

9.2 Clock driver Characteristics

Symbol	Parameter	Conditions	T _C = TBD V _{DD} = 1.35V(1.28V~1.45V) & 1.5V(1.425~1.575V)		Units	Notes
			Min	Max		
t _{jit} (cc)	Cycle-to-cycle period jitter		0	40	ps	
t _{STAB}	Stabilization time		-	6	us	
t _{fdyn}	Dynamic phase offset		-50	50	ps	
t _{CKsk}	Clock Output skew			50	ps	
t _{jit} (per)	Yn Clock Period jitter		-40	40	ps	
t _{jit} (hper)	Half period jitter		-50	50	ps	
t _{Qsk1}	Qn Output to clock tolerance (Standard 1/2 -Clock Pre-Launch)	Output Inversion enabled	-100	200	ps	
		Output Inversion disabled	-100	300		
t _{Qsk1}	Output clock tolerance (3/4 Clock Pre-Launch)	Output Inversion enabled	-100	200	ps	
		Output Inversion disabled	-100	300		
t _{dynoff}	Maximum re-driven dynamic clock off-set		-80	80	ps	

10. Function Block Diagram:

10.1 8GB, 1Gx72 Module (Populated as 1 rank of x4 DDR3 SDRAMs)

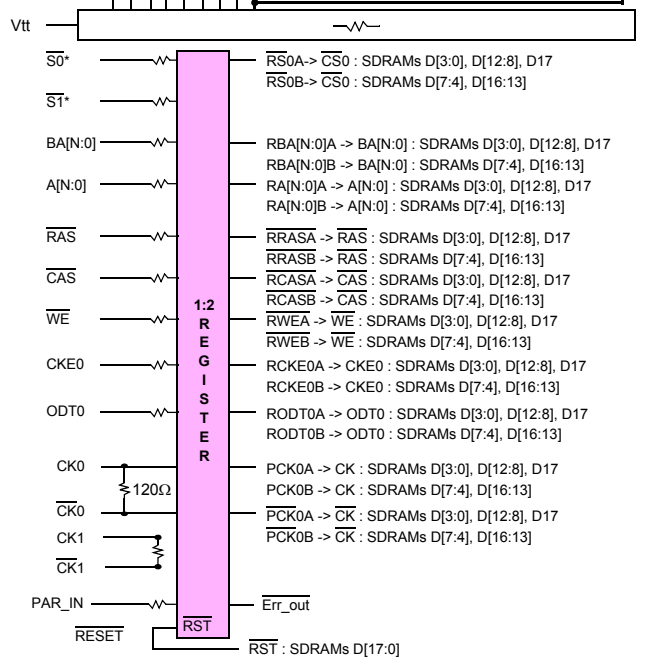
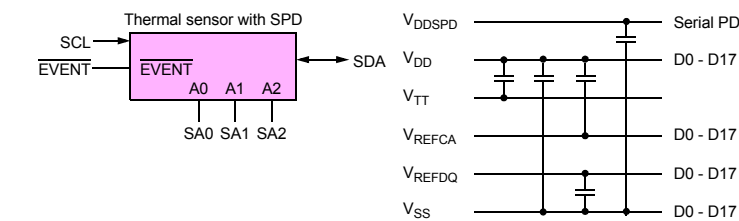
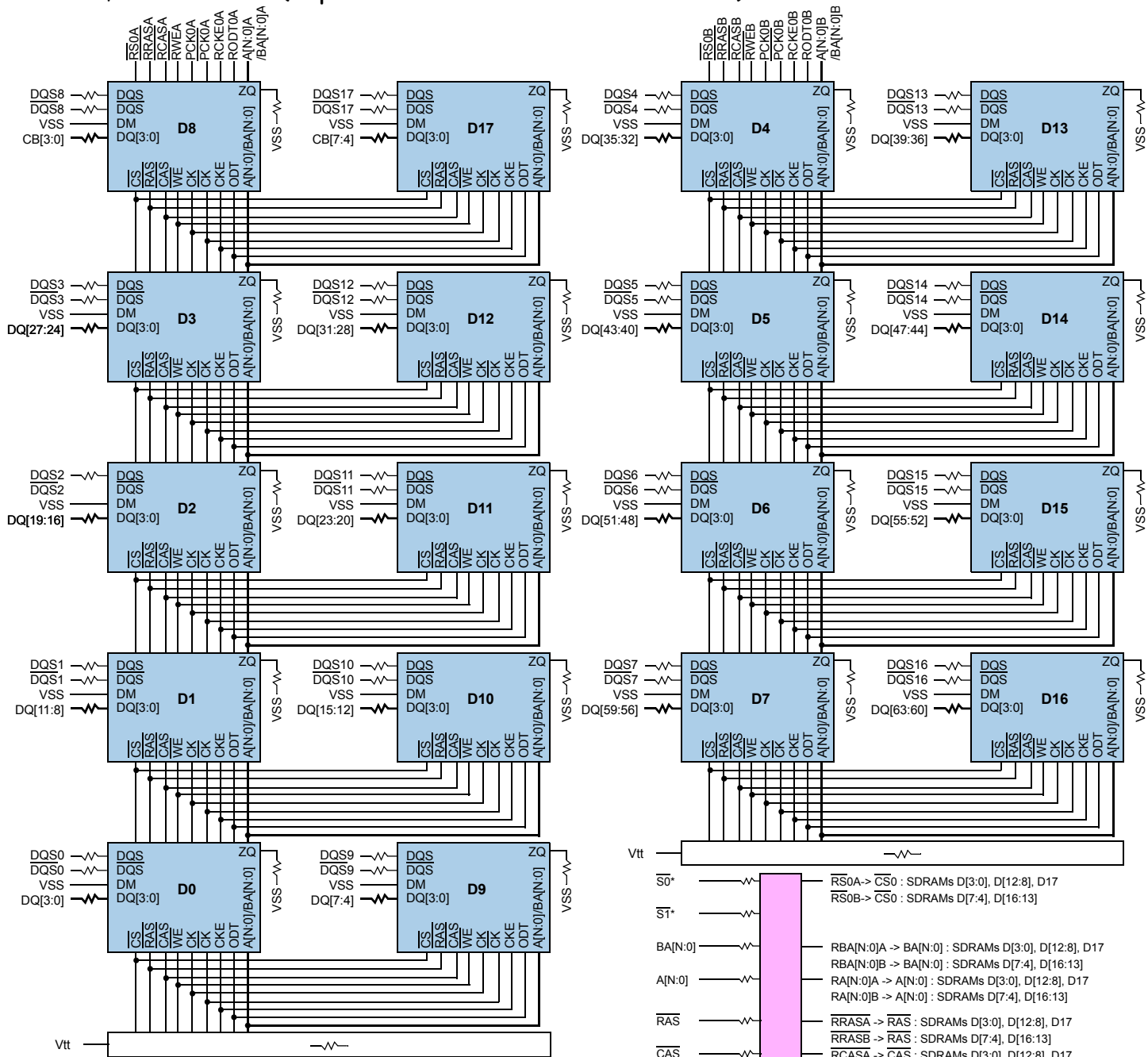

NOTE :

1. Unless otherwise noted, resistor values are 15Ω ± 5%.
2. See the wiring diagrams for all resistors associated with the command, address and control bus.
3. ZQ resistors are 240Ω ± 1% . For all other resistor values refer to the appropriate wiring diagram.

*[S3:2], CKE1, ODT1, CK1 and CK1 are NC
(Unused register inputs ODT1 and CKE1 have a 330Ω resistor to ground)



10.2 8GB, 16x72 Module (Populated as 2 ranks of x8 DDR3 SDRAMs)

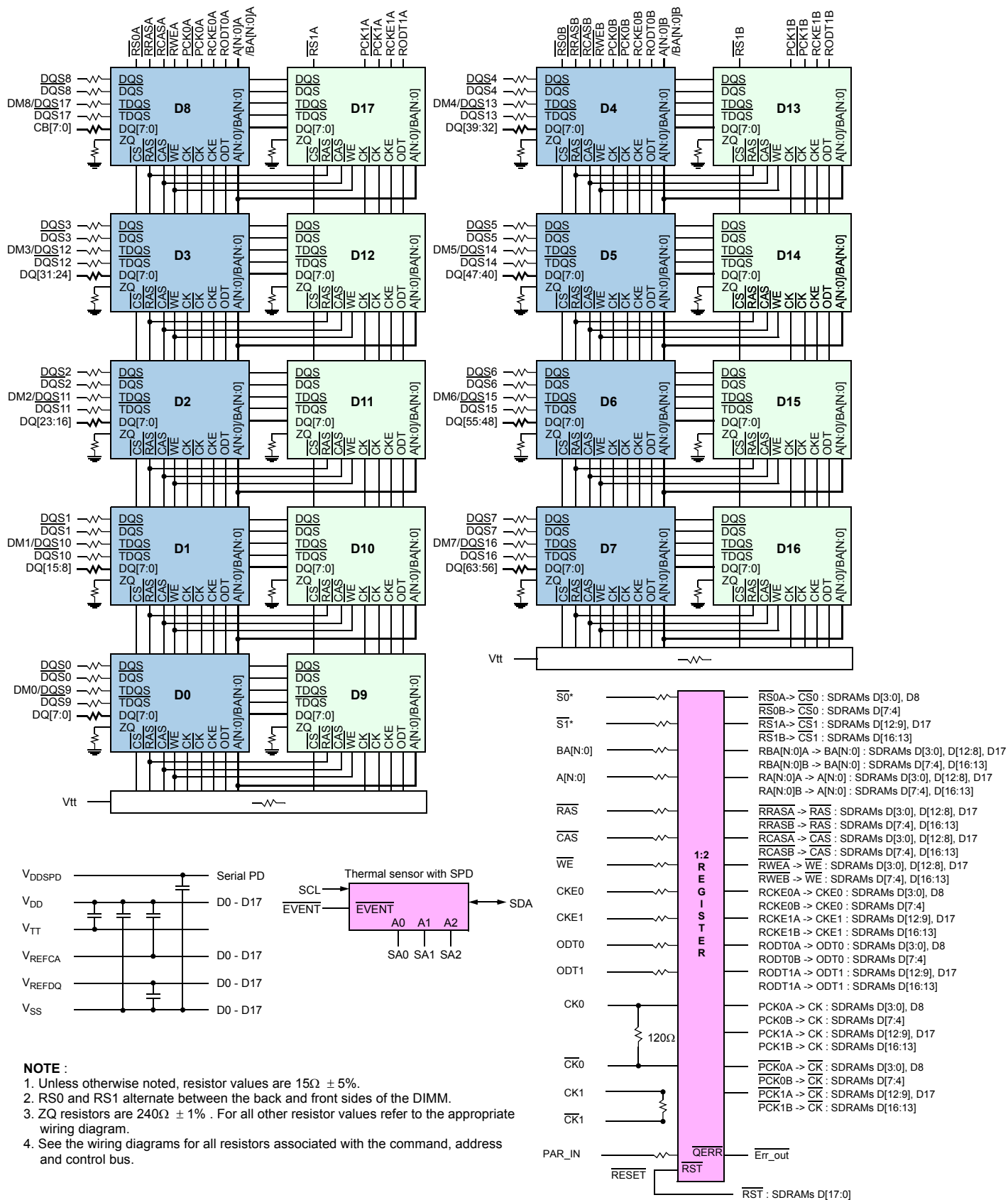

*S[3:2], CKE1, ODT1, CK1 and CK1 are NC



10.3 16GB, 2Gx72 Module (Populated as 2 ranks of x4 DDR3 SDRAMs)

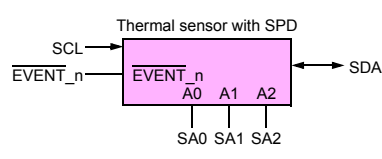
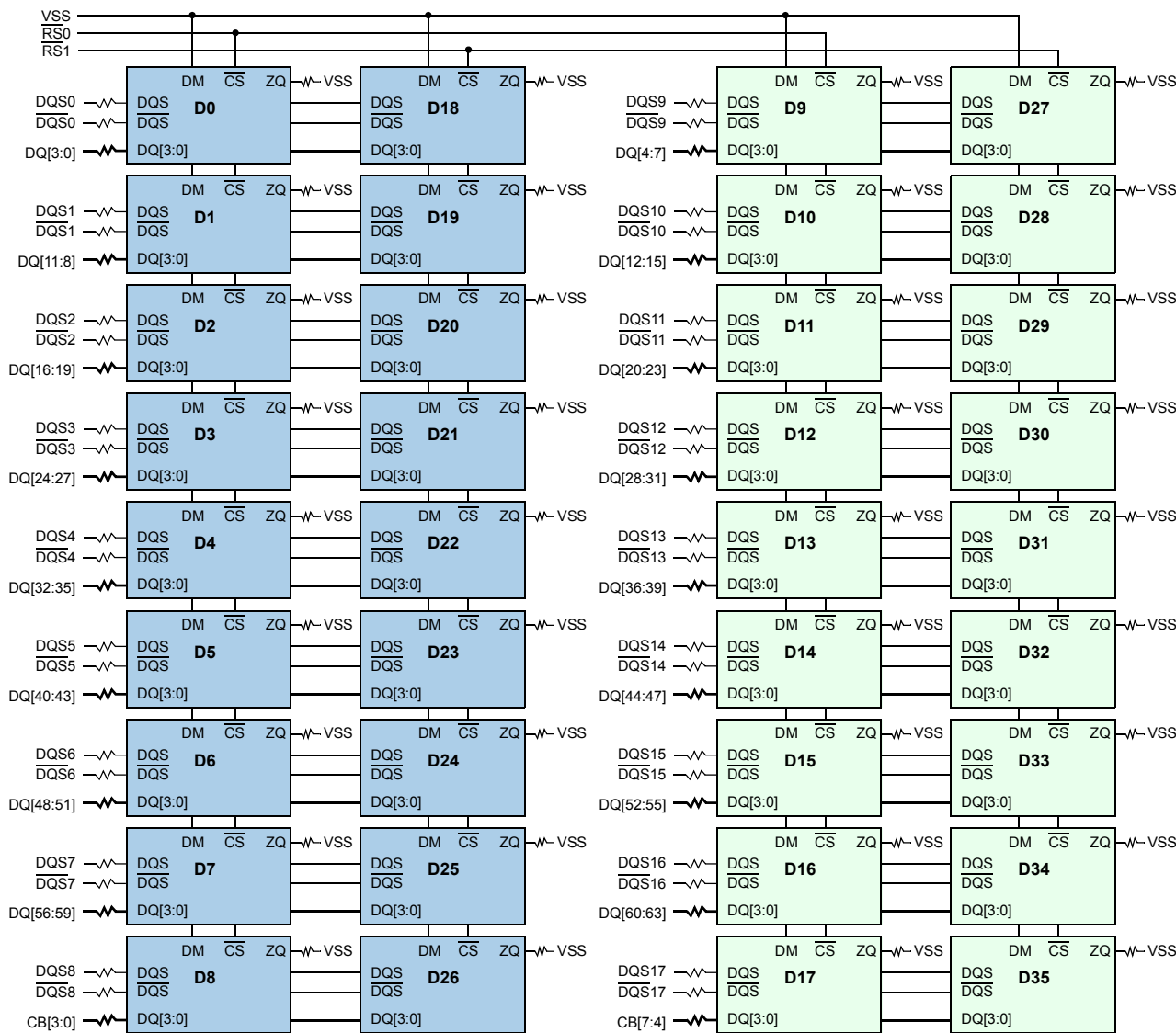

Serial PD w/integrated Thermal Sensor

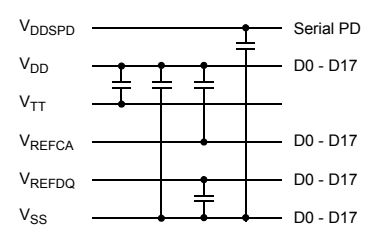

NOTE :
 1. ZQ resistors are 240Ω ± 1% . For all other resistor values refer to the appropriate wiring diagram.

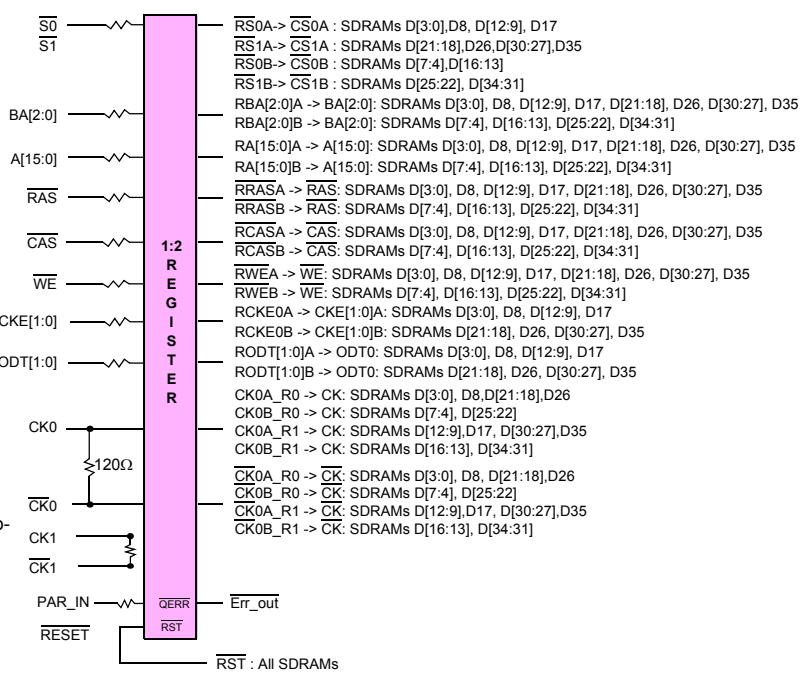

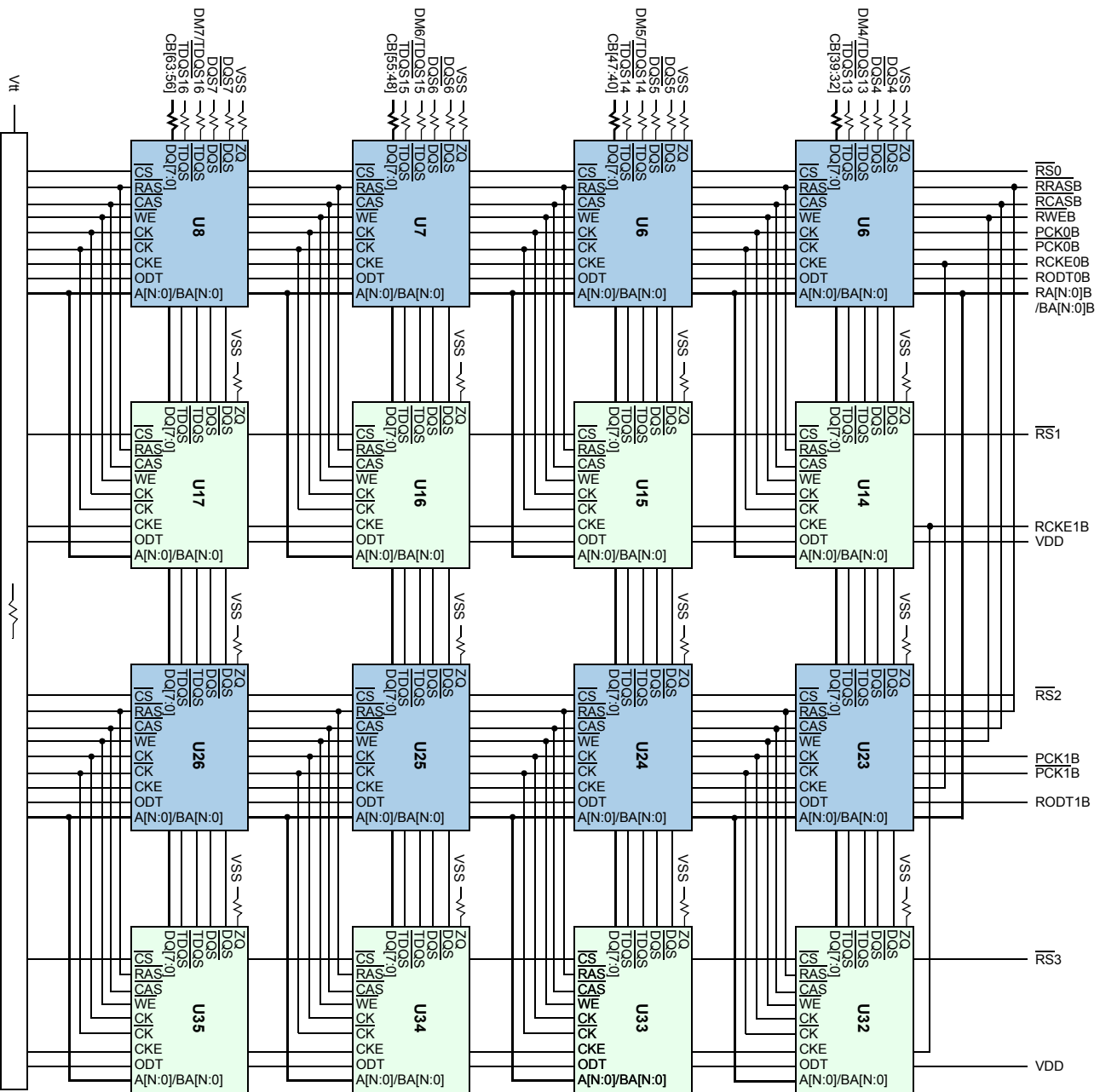

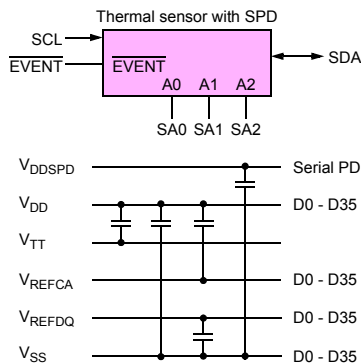

NOTE :

1. Unless otherwise noted, resistor values are $15\Omega \pm 5\%$.
2. See the wiring diagrams for all resistors associated with the command, address and control bus.
3. ZQ resistors are $240\Omega \pm 1\%$. For all other resistor values refer to the appropriate wiring diagram.

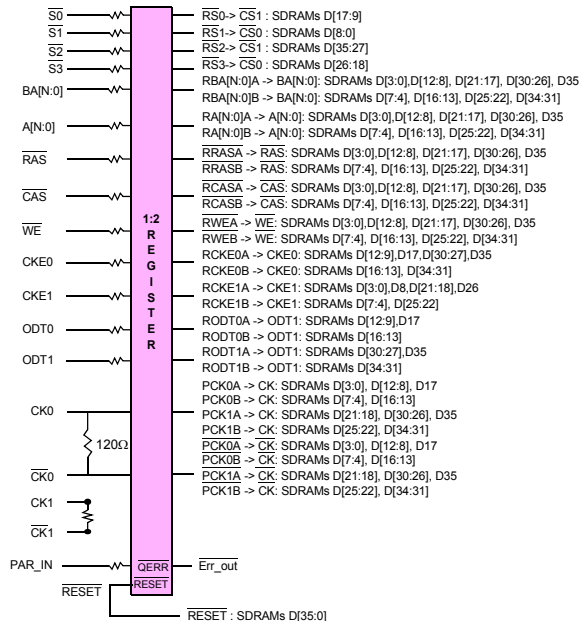

10.5 32GB, 4x72 Module (Populated as 4 ranks of x4 DDR3 SDRAMs)

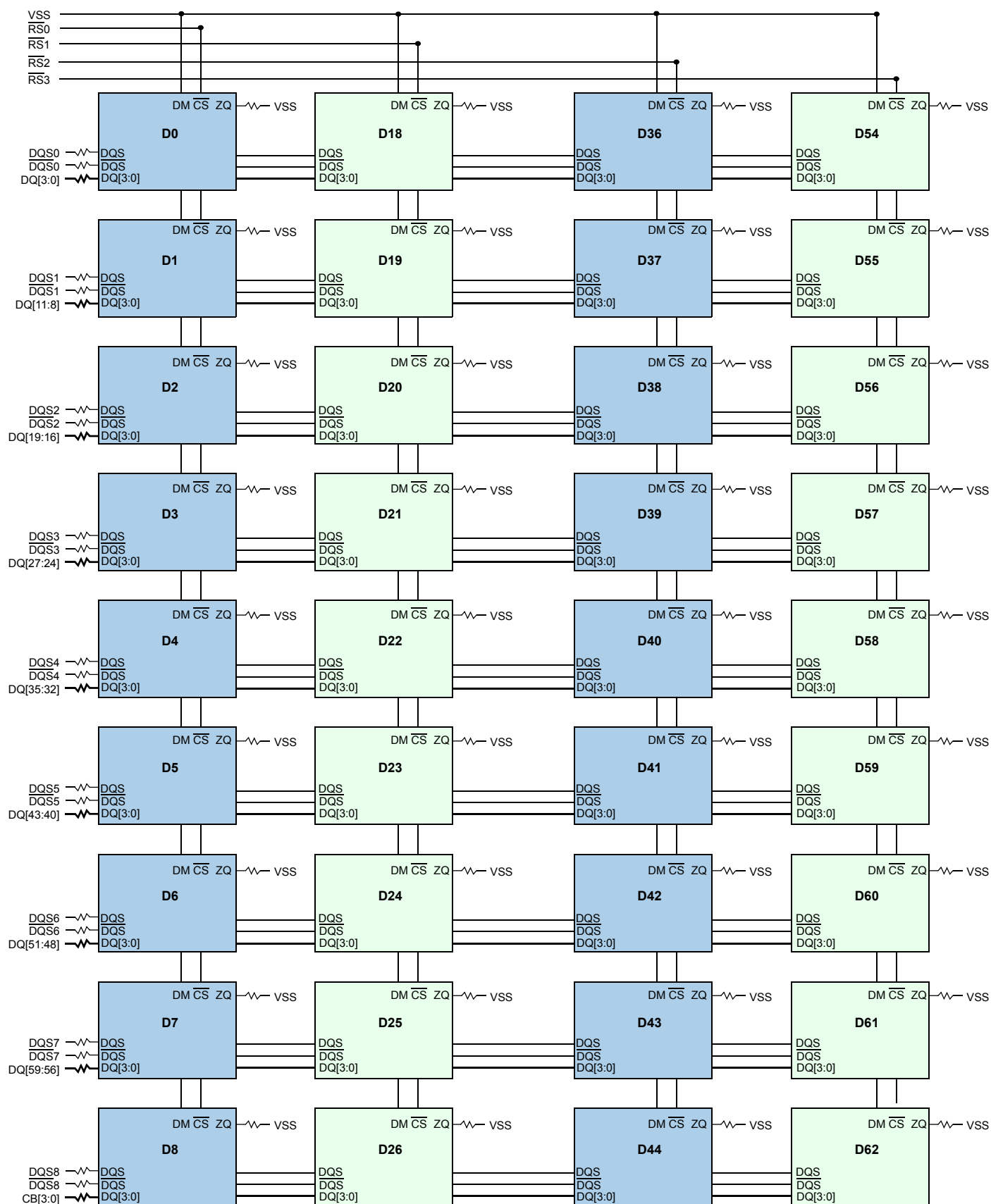

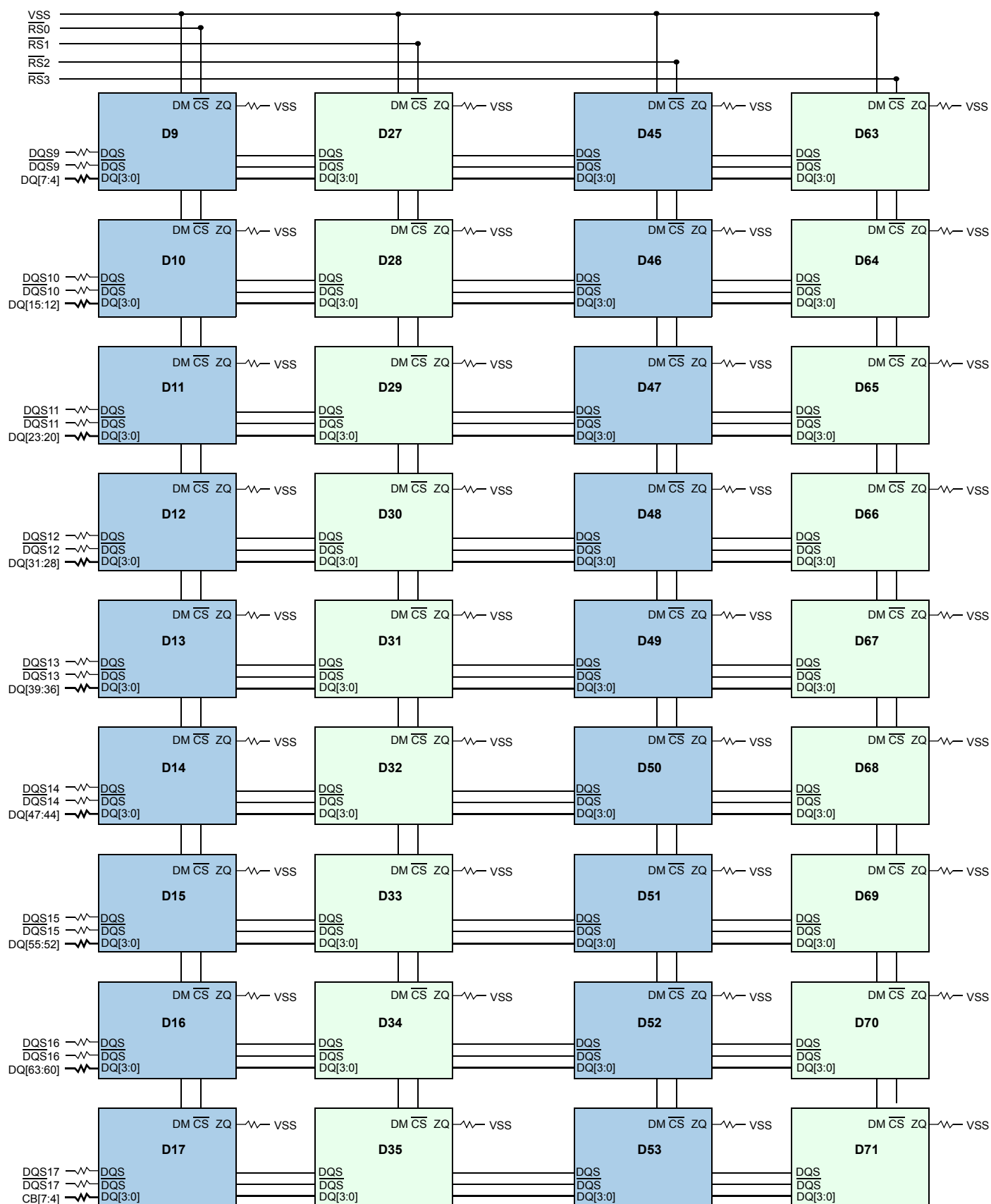

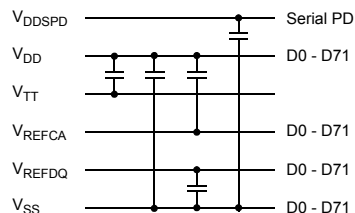
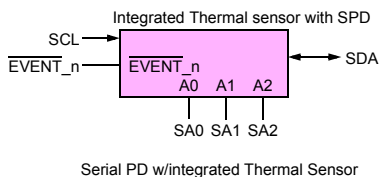

NOTE :

1. Unless otherwise noted, resistor values are $15\Omega \pm 5\%$.
2. See the wiring diagrams for all resistors associated with the command, address and control bus.
3. ZQ resistors are $240\Omega \pm 1\%$. For all other resistor values refer to the appropriate wiring diagram.

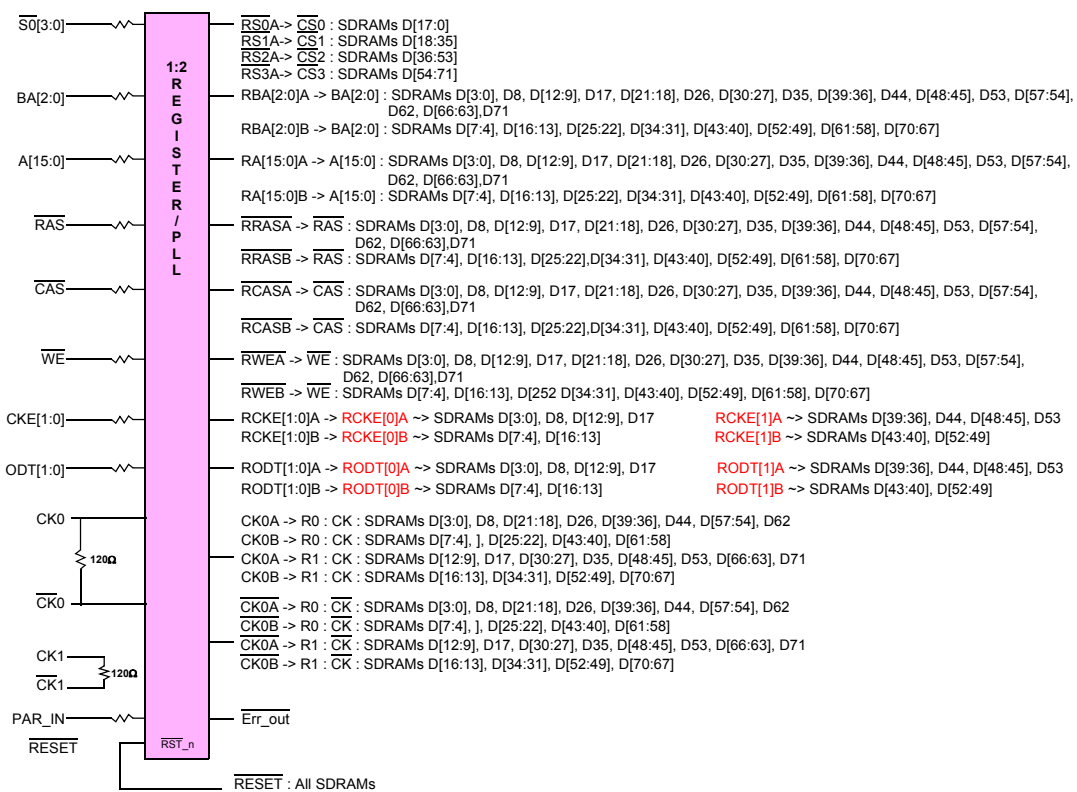

11. Absolute Maximum Ratings

11.1 Absolute Maximum DC Ratings

Symbol	Parameter	Rating	Units	NOTE
V_{DD}	Voltage on V_{DD} pin relative to V_{SS}	-0.4 V ~ 1.975 V	V	1,3
V_{DDQ}	Voltage on V_{DDQ} pin relative to V_{SS}	-0.4 V ~ 1.975 V	V	1,3
V_{IN}, V_{OUT}	Voltage on any pin relative to V_{SS}	-0.4 V ~ 1.975 V	V	1
T_{STG}	Storage Temperature	-55 to +100	°C	1, 2

NOTE :

- Stresses greater than those listed under "Absolute Maximum Ratings" may cause permanent damage to the device. This is a stress rating only and functional operation of the device at these or any other conditions above those indicated in the operational sections of this specification is not implied. Exposure to absolute maximum rating conditions for extended periods may affect reliability.
- Storage Temperature is the case surface temperature on the center/top side of the DRAM. For the measurement conditions, please refer to JESD51-2 standard.
- V_{DD} and V_{DDQ} must be within 300mV of each other at all times; and V_{REF} must be not greater than $0.6 \times V_{DDQ}$. When V_{DD} and V_{DDQ} are less than 500mV; V_{REF} may be equal to or less than 300mV.

11.2 DRAM Component Operating Temperature Range

Symbol	Parameter	rating	Unit	NOTE
T_{OPER}	Operating Temperature Range	0 to 95	°C	1, 2, 3

NOTE :

- Operating Temperature T_{OPER} is the case surface temperature on the center/top side of the DRAM. For measurement conditions, please refer to the JEDEC document JE51-2.
- The Normal Temperature Range specifies the temperatures where all DRAM specifications will be supported. During operation, the DRAM case temperature must be maintained between 0-85°C under all operating conditions
- Some applications require operation of the Extended Temperature Range between 85°C and 95°C case temperature. Full specifications are guaranteed in this range, but the following additional conditions apply:
 - Refresh commands must be doubled in frequency, therefore reducing the refresh interval $tREFI$ to 3.9us.
 - If Self-Refresh operation is required in the Extended Temperature Range, then it is mandatory to either use the Manual Self-Refresh mode with Extended Temperature Range capability (MR2 A6 = 0b and MR2 A7 = 1b), in this case $IDD6$ current can be increased around 10~20% than normal Temperature range.

12. AC & DC Operating Conditions

12.1 Recommended DC Operating Conditions

Symbol	Parameter	Operation Voltage	Rating			Units	NOTE
			Min.	Typ.	Max.		
V_{DD}	Supply Voltage	1.35V	1.283	1.35	1.45	V	1, 2, 3
		1.5V	1.425	1.5	1.575	V	1, 2, 3
V_{DDQ}	Supply Voltage for Output	1.35V	1.283	1.35	1.45	V	1, 2, 3
		1.5V	1.425	1.5	1.575	V	1, 2, 3

NOTE:

- Under all conditions V_{DDQ} must be less than or equal to V_{DD} .
- V_{DDQ} tracks with V_{DD} . AC parameters are measured with V_{DD} and V_{DDQ} tied together.
- V_{DD} & V_{DDQ} rating are determined by operation voltage.

13. AC & DC Input Measurement Levels

13.1 AC & DC Logic Input Levels for Single-ended Signals

[Table 2] Single Ended AC and DC input levels for Command and Address

Symbol	Parameter	DDR3-800/1066/1333/1600		Unit	NOTE
		Min.	Max.		
1.35V					
V _{IH,CA} (DC90)	DC input logic high	V _{REF} + 90	V _{DD}	mV	1,5 ^{a)}
V _{IL,CA} (DC90)	DC input logic low	V _{SS}	V _{REF} - 90	mV	1,6 ^{a)}
V _{IH,CA} (AC160)	AC input logic high	V _{REF} + 160	Note 2	mV	1,2
V _{IL,CA} (AC160)	AC input logic low	Note 2	V _{REF} - 160	mV	1,2
V _{IH,CA} (AC135)	AC input logic high	V _{REF} +135	Note 2	mV	1,2
V _{IL,CA} (AC135)	AC input logic lowM	Note 2	V _{REF} -135	mV	1,2
V _{REFCA} (DC)	Reference Voltage for ADD, CMD inputs	0.49*V _{DD}	0.51*V _{DD}	V	3,4
1.5V					
V _{IH,CA} (DC100)	DC input logic high	V _{REF} + 100	V _{DD}	mV	1,5 ^{b)}
V _{IL,CA} (DC100)	DC input logic low	V _{SS}	V _{REF} - 100	mV	1,6 ^{b)}
V _{IH,CA} (AC175)	AC input logic high	V _{REF} + 175	Note 2	mV	1,2,7
V _{IL,CA} (AC175)	AC input logic low	Note 2	V _{REF} - 175	mV	1,2,8
V _{IH,CA} (AC150)	AC input logic high	V _{REF} +150	Note 2	mV	1,2,7
V _{IL,CA} (AC150)	AC input logic low	Note 2	V _{REF} -150	mV	1,2,8
V _{REFCA} (DC)	Reference Voltage for ADD, CMD inputs	0.49*V _{DD}	0.51*V _{DD}	V	3,4

NOTE :

1. For input only pins except $\overline{\text{RESET}}$, V_{REF} = V_{REFCA}(DC)
2. See "Overshoot and Undershoot specifications" section.
3. The AC peak noise on V_{REF} may not allow V_{REF} to deviate from V_{REF}(DC) by more than ± 1% V_{DD} (for reference : approx. ± 15mV)
4. For reference : approx. V_{DD}/2 ± 15mV
5. V_{IH}(dc) is used as a simplified symbol for V_{IH,CA}(^{a)} 1.35V : DC90, ^{b)} 1.5V : DC100)
6. V_{IL}(dc) is used as a simplified symbol for V_{IL,CA}(^{a)} 1.35V : DC90, ^{b)} 1.5V : DC100)
7. V_{IH}(ac) is used as a simplified symbol for V_{IH,CA}(AC175) and V_{IH,CA}(AC150); V_{IH,CA}(AC175) value is used when V_{REF} + 175mV is referenced and V_{IH,CA}(AC150) value is used when V_{REF} + 150mV is referenced.
8. V_{IL}(ac) is used as a simplified symbol for V_{IL,CA}(AC175) and V_{IL,CA}(AC150); V_{IL,CA}(AC175) value is used when V_{REF} - 175mV is referenced and V_{IL,CA}(AC150) value is used when V_{REF} - 150mV is referenced.

[Table 3] Single Ended AC and DC input levels for DQ and DM

Symbol	Parameter	DDR3-800/1066		DDR3-1333/1600		Unit	NOTE
		Min.	Max.	Min.	Max.		
1.35V							
V _{IH.DQ} (DC90)	DC input logic high	V _{REF} + 90	V _{DD}	V _{REF} + 90	V _{DD}	mV	1,5 ^{a)}
V _{IL.DQ} (DC90)	DC input logic low	V _{SS}	V _{REF} - 90	V _{SS}	V _{REF} - 90	mV	1,6 ^{a)}
V _{IH.DQ} (AC160)	AC input logic high	V _{REF} + 160	Note 2	-	-	mV	1,2
V _{IL.DQ} (AC160)	AC input logic low	Note 2	V _{REF} - 160	-	-	mV	1,2
V _{IH.DQ} (AC135)	AC input logic high	V _{REF} + 135	Note 2	V _{REF} + 135	Note 2	mV	1,2
V _{IL.DQ} (AC135)	AC input logic low	Note 2	V _{REF} - 135	Note 2	V _{REF} - 135	mV	1,2
V _{REFDQ} (DC)	Reference Voltage for DQ, DM inputs	0.49*V _{DD}	0.51*V _{DD}	0.49*V _{DD}	0.51*V _{DD}	V	3,4
1.5V							
V _{IH.DQ} (DC100)	DC input logic high	V _{REF} + 100	V _{DD}	V _{REF} + 100	V _{DD}	mV	1,5 ^{b)}
V _{IL.DQ} (DC100)	DC input logic low	V _{SS}	V _{REF} - 100	V _{SS}	V _{REF} - 100	mV	1,6 ^{b)}
V _{IH.DQ} (AC175)	AC input logic high	V _{REF} + 175	NOTE 2	-	-	mV	1,2,7
V _{IL.DQ} (AC175)	AC input logic low	NOTE 2	V _{REF} - 175	-	-	mV	1,2,8
V _{IH.DQ} (AC150)	AC input logic high	V _{REF} + 150	NOTE 2	V _{REF} + 150	NOTE 2	mV	1,2,7
V _{IL.DQ} (AC150)	AC input logic low	NOTE 2	V _{REF} - 150	NOTE 2	V _{REF} - 150	mV	1,2,8
V _{REFDQ} (DC)	Reference Voltage for DQ, DM inputs	0.49*V _{DD}	0.51*V _{DD}	0.49*V _{DD}	0.51*V _{DD}	V	3,4

NOTE :

- For input only pins except $\overline{\text{RESET}}$, V_{REF} = V_{REFDQ}(DC)
- See 'Overshoot/Undershoot Specification' on page 18.
- The AC peak noise on V_{REF} may not allow V_{REF} to deviate from V_{REF}(DC) by more than ± 1% V_{DD} (for reference : approx. ± 15mV)
- For reference : approx. V_{DD}/2 ± 15mV
- V_{IH}(dc) is used as a simplified symbol for V_{IH,CA}(^{a)} 1.35V : DC90, ^{b)} 1.5V : DC100)
- V_{IL}(dc) is used as a simplified symbol for V_{IL,CA}(^{a)} 1.35V : DC90, ^{b)} 1.5V : DC100)
- V_{IH}(ac) is used as a simplified symbol for V_{IH,DQ}(AC175), V_{IH,DQ}(AC150) ; V_{IH,DQ}(AC175) value is used when V_{REF} + 175mV is referenced, V_{IH,DQ}(AC150) value is used when V_{REF} + 150mV is referenced.
- V_{IL}(ac) is used as a simplified symbol for V_{IL,DQ}(AC175), V_{IL,DQ}(AC150) ; V_{IL,DQ}(AC175) value is used when V_{REF} - 175mV is referenced, V_{IL,DQ}(AC150) value is used when V_{REF} - 150mV is referenced.

13.2 V_{REF} Tolerances

The dc-tolerance limits and ac-noise limits for the reference voltages V_{REFCA} and V_{REFDQ} are illustrate in Figure 1. It shows a valid reference voltage $V_{REF}(t)$ as a function of time. (V_{REF} stands for V_{REFCA} and V_{REFDQ} likewise).

$V_{REF}(DC)$ is the linear average of $V_{REF}(t)$ over a very long period of time (e.g. 1 sec). This average has to meet the min/max requirements of V_{REF} . Furthermore $V_{REF}(t)$ may temporarily deviate from $V_{REF}(DC)$ by no more than $\pm 1\% V_{DD}$.

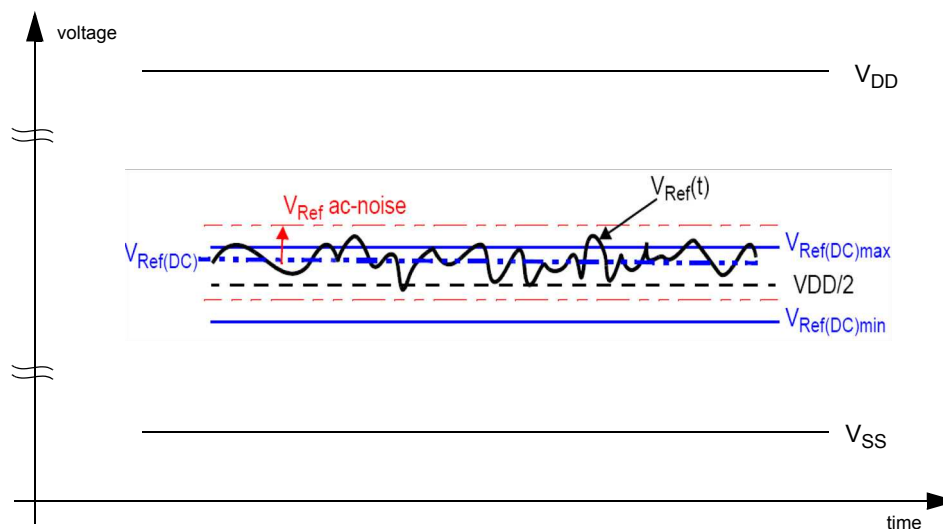

Figure 1. Illustration of $V_{REF}(DC)$ tolerance and V_{REF} ac-noise limits

The voltage levels for setup and hold time measurements $V_{IH}(AC)$, $V_{IH}(DC)$, $V_{IL}(AC)$ and $V_{IL}(DC)$ are dependent on V_{REF} .

" V_{REF} " shall be understood as $V_{REF}(DC)$, as defined in Figure 1.

This clarifies, that dc-variations of V_{REF} affect the absolute voltage a signal has to reach to achieve a valid high or low level and therefore the time to which setup and hold is measured. System timing and voltage budgets need to account for $V_{REF}(DC)$ deviations from the optimum position within the data-eye of the input signals.

This also clarifies that the DRAM setup/hold specification and derating values need to include time and voltage associated with V_{REF} ac-noise. Timing and voltage effects due to ac-noise on V_{REF} up to the specified limit ($\pm 1\%$ of V_{DD}) are included in DRAM timings and their associated deratings.

13.3 AC and DC Logic Input Levels for Differential Signals

13.3.1 Differential Signals Definition

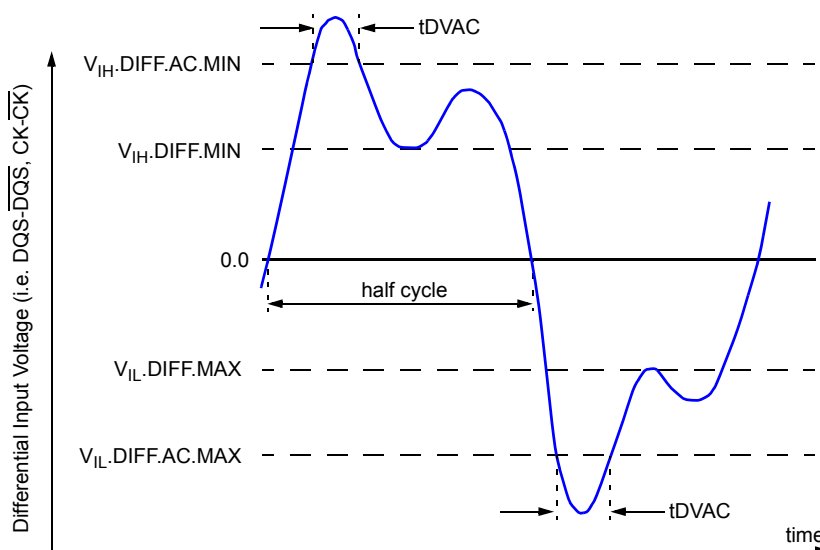

Figure 2. Definition of differential ac-swing and "time above ac level" tDVAC

13.3.2 Differential Swing Requirement for Clock (CK - CK-bar) and Strobe (DQS - DQS-bar)

Symbol	Parameter	DDR3-800/1066/1333/1600				unit	NOTE
		1.35V		1.5V			
		min	max	min	max		
V_{IHdiff}	differential input high	+0.18	NOTE 3	+0.20	NOTE 3	V	1
V_{ILdiff}	differential input low	NOTE 3	-0.18	NOTE 3	-0.20	V	1
$V_{IHdiff}(AC)$	differential input high ac	$2 \times (V_{IH}(AC) - V_{REF})$	NOTE 3	$2 \times (V_{IH}(AC) - V_{REF})$	NOTE 3	V	2
$V_{ILdiff}(AC)$	differential input low ac	NOTE 3	$2 \times (V_{IL}(AC) - V_{REF})$	NOTE 3	$2 \times (V_{IL}(AC) - V_{REF})$	V	2

- NOTE :**
- Used to define a differential signal slew-rate.
 - for CK - CK-bar use $V_{IH}/V_{IL}(AC)$ of ADD/CMD and V_{REFCA} ; for DQS - DQS-bar use $V_{IH}/V_{IL}(AC)$ of DQs and V_{REFDQ} ; if a reduced ac-high or ac-low level is used for a signal group, then the reduced level applies also here.
 - These values are not defined, however they single-ended signals CK, CK-bar, DQS, DQS-bar need to be within the respective limits ($V_{IH}(DC)$ max, $V_{IL}(DC)$ min) for single-ended signals as well as the limitations for overshoot and undershoot. Refer to "overshoot and Undersheet Specification"

[Table 4] Allowed time before ringback (tDVAC) for CK - $\overline{\text{CK}}$ and DQS - $\overline{\text{DQS}}$ (1.35V)

Slew Rate [V/ns]	tDVAC [ps] @ $ V_{IH/Ldiff}(AC) = 320mV$		tDVAC [ps] @ $ V_{IH/Ldiff}(AC) = 270mV$	
	min	max	min	max
> 4.0	TBD	-	TBD	-
4.0	TBD	-	TBD	-
3.0	TBD	-	TBD	-
2.0	TBD	-	TBD	-
1.8	TBD	-	TBD	-
1.6	TBD	-	TBD	-
1.4	TBD	-	TBD	-
1.2	TBD	-	TBD	-
1.0	TBD	-	TBD	-
< 1.0	TBD	-	TBD	-

[Table 5] Allowed time before ringback (tDVAC) for CK - $\overline{\text{CK}}$ and DQS - $\overline{\text{DQS}}$ (1.5V)

Slew Rate [V/ns]	tDVAC [ps] @ $ V_{IH/Ldiff}(AC) = 350mV$		tDVAC [ps] @ $ V_{IH/Ldiff}(AC) = 300mV$	
	min	max	min	max
> 4.0	75	-	175	-
4.0	57	-	170	-
3.0	50	-	167	-
2.0	38	-	163	-
1.8	34	-	162	-
1.6	29	-	161	-
1.4	22	-	159	-
1.2	13	-	155	-
1.0	0	-	150	-
< 1.0	0	-	150	-

13.3.3 Single-ended Requirements for Differential Signals

Each individual component of a differential signal (CK, DQS, \overline{CK} , \overline{DQS}) has also to comply with certain requirements for single-ended signals. CK and \overline{CK} have to approximately reach V_{SEHmin} / V_{SELmax} (approximately equal to the ac-levels ($V_{IH(AC)} / V_{IL(AC)}$) for ADD/CMD signals) in every half-cycle. DQS, \overline{DQS} have to reach V_{SEHmin} / V_{SELmax} (approximately the ac-levels ($V_{IH(AC)} / V_{IL(AC)}$) for DQ signals) in every half-cycle proceeding and following a valid transition. Note that the applicable ac-levels for ADD/CMD and DQ's might be different per speed-bin etc. E.g. if $V_{IH150(AC)}/V_{IL150(AC)}$ is used for ADD/CMD signals, then these ac-levels apply also for the single-ended signals CK and \overline{CK} .

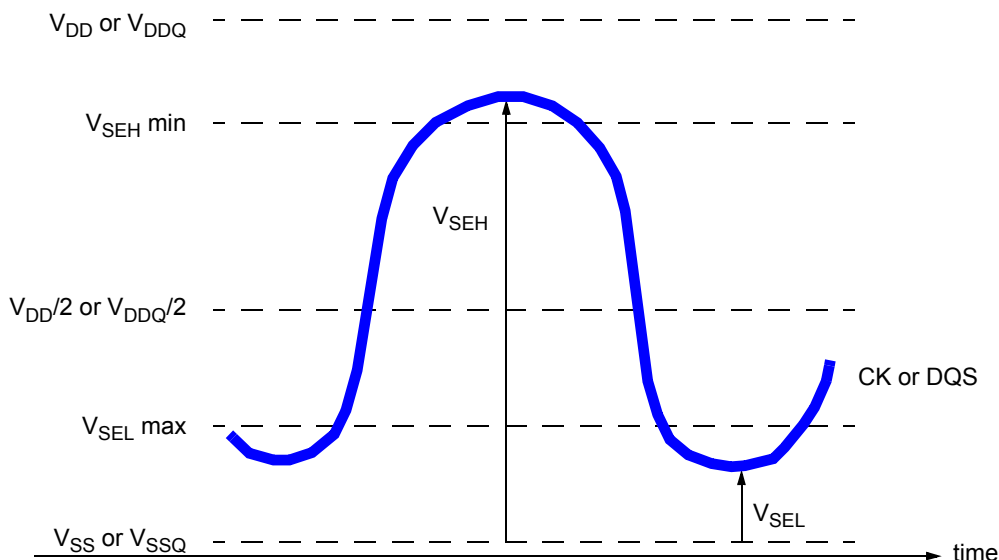

Figure 3. Single-ended requirement for differential signals

Note that while ADD/CMD and DQ signal requirements are with respect to V_{REF} , the single-ended components of differential signals have a requirement with respect to $V_{DD}/2$; this is nominally the same. The transition of single-ended signals through the ac-levels is used to measure setup time. For single-ended components of differential signals the requirement to reach V_{SELmax} , V_{SEHmin} has no bearing on timing, but adds a restriction on the common mode characteristics of these signals.

[Table 6] Single ended levels for CK, DQS, \overline{CK} , \overline{DQS}

Symbol	Parameter	DDR3-800/1066/1333/1600		Unit	NOTE
		Min	Max		
V_{SEH}	Single-ended high-level for strobes	$(V_{DD}/2)+0.175$	NOTE 3	V	1, 2
	Single-ended high-level for CK, \overline{CK}	$(V_{DD}/2)+0.175$	NOTE 3	V	1, 2
V_{SEL}	Single-ended low-level for strobes	NOTE 3	$(V_{DD}/2)-0.175$	V	1, 2
	Single-ended low-level for CK, \overline{CK}	NOTE 3	$(V_{DD}/2)-0.175$	V	1, 2

- NOTE :
- For CK, \overline{CK} use $V_{IH}/V_{IL(AC)}$ of ADD/CMD; for strobes (DQS, \overline{DQS}) use $V_{IH}/V_{IL(AC)}$ of DQs.
 - $V_{IH(AC)}/V_{IL(AC)}$ for DQs is based on V_{REFDQ} ; $V_{IH(AC)}/V_{IL(AC)}$ for ADD/CMD is based on V_{REFCA} ; if a reduced ac-high or ac-low level is used for a signal group, then the reduced level applies also here
 - These values are not defined, however the single-ended signals CK, \overline{CK} , DQS, \overline{DQS} need to be within the respective limits ($V_{IH(DC)}$ max, $V_{IL(DC)}$ min) for single-ended signals as well as the limitations for overshoot and undershoot. Refer to "Overshoot and Undershoot Specification"

13.3.4 Differential Input Cross Point Voltage

To guarantee tight setup and hold times as well as output skew parameters with respect to clock and strobe, each cross point voltage of differential input signals (CK, \overline{CK} and DQS, \overline{DQS}) must meet the requirements in below table. The differential input cross point voltage V_{IX} is measured from the actual cross point of true and complement signal to the mid level between of V_{DD} and V_{SS} .

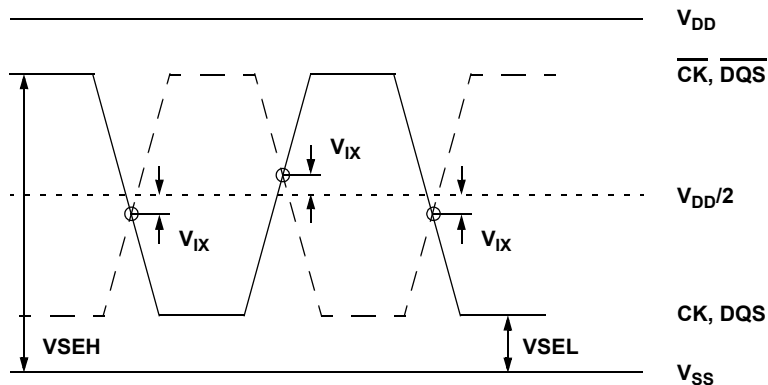

Figure 4. V_{IX} Definition

[Table 7] Cross point voltage for differential input signals (CK, DQS) : 1.35V

Symbol	Parameter	DDR3L-800/1066/1333/1600		Unit	NOTE
		Min	Max		
V_{IX}	Differential Input Cross Point Voltage relative to $V_{DD}/2$ for CK, \overline{CK}	-150	150	mV	1
V_{IX}	Differential Input Cross Point Voltage relative to $V_{DD}/2$ for DQS, \overline{DQS}	-150	150	mV	

NOTE :

- The relation between V_{ix} Min/Max and V_{SEL}/V_{SEH} should satisfy following.
 $(V_{DD}/2) + V_{ix}(\text{Min}) - V_{SEL} \geq 25\text{mV}$
 $V_{SEH} - ((V_{DD}/2) + V_{ix}(\text{Max})) \geq 25\text{mV}$

[Table 8] Cross point voltage for differential input signals (CK, DQS) : 1.5V

Symbol	Parameter	DDR3-800/1066/1333/1600		Unit	NOTE
		Min	Max		
V_{IX}	Differential Input Cross Point Voltage relative to $V_{DD}/2$ for CK, \overline{CK}	-150	150	mV	
V_{IX}	Differential Input Cross Point Voltage relative to $V_{DD}/2$ for DQS, \overline{DQS}	-175	175	mV	1
V_{IX}	Differential Input Cross Point Voltage relative to $V_{DD}/2$ for DQS, \overline{DQS}	-150	150	mV	

NOTE :

- Extended range for V_{IX} is only allowed for clock and if single-ended clock input signals CK and \overline{CK} are monotonic, have a single-ended swing V_{SEL} / V_{SEH} of at least $V_{DD}/2 \pm 250$ mV, and the differential slew rate of CK- \overline{CK} is larger than 3 V/ ns.

13.4 Slew Rate Definition for Single Ended Input Signals

See "Address / Command Setup, Hold and Derating" for single-ended slew rate definitions for address and command signals.
See "Data Setup, Hold and Slew Rate Derating" for single-ended slew rate definitions for data signals.

13.5 Slew rate definition for Differential Input Signals

Input slew rate for differential signals (CK, \overline{CK} and DQS, \overline{DQS}) are defined and measured as shown in below.

[Table 9] Differential input slew rate definition

Description	Measured		Defined by
	From	To	
Differential input slew rate for rising edge (CK- \overline{CK} and DQS- \overline{DQS})	$V_{ILdiffmax}$	$V_{IHdiffmin}$	$\frac{V_{IHdiffmin} - V_{ILdiffmax}}{\Delta TRdiff}$
Differential input slew rate for falling edge (CK- \overline{CK} and DQS- \overline{DQS})	$V_{IHdiffmin}$	$V_{ILdiffmax}$	$\frac{V_{IHdiffmin} - V_{ILdiffmax}}{\Delta TFdiff}$

NOTE : The differential signal (i.e. CK - \overline{CK} and DQS - \overline{DQS}) must be linear between these thresholds

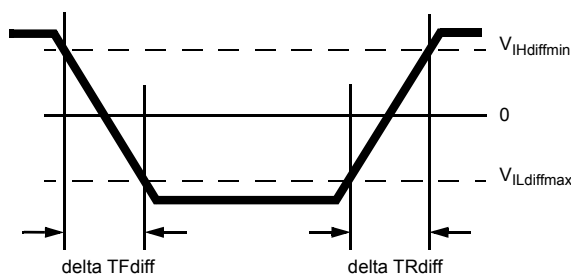

Figure 5. Differential input slew rate definition for DQS, \overline{DQS} and CK, \overline{CK}

14. AC & DC Output Measurement Levels

14.1 Single Ended AC and DC Output Levels

[Table 10] Single Ended AC and DC output levels

Symbol	Parameter	DDR3-800/1066/1333/1600	Units	NOTE
$V_{OH(DC)}$	DC output high measurement level (for IV curve linearity)	$0.8 \times V_{DDQ}$	V	
$V_{OM(DC)}$	DC output mid measurement level (for IV curve linearity)	$0.5 \times V_{DDQ}$	V	
$V_{OL(DC)}$	DC output low measurement level (for IV curve linearity)	$0.2 \times V_{DDQ}$	V	
$V_{OH(AC)}$	AC output high measurement level (for output SR)	$V_{TT} + 0.1 \times V_{DDQ}$	V	1
$V_{OL(AC)}$	AC output low measurement level (for output SR)	$V_{TT} - 0.1 \times V_{DDQ}$	V	1

NOTE : 1. The swing of $\pm 0.1 \times V_{DDQ}$ is based on approximately 50% of the static single ended output high or low swing with a driver impedance of 40Ω and an effective test load of 25Ω to $V_{TT} = V_{DDQ}/2$.

14.2 Differential AC and DC Output Levels

[Table 11] Differential AC and DC output levels

Symbol	Parameter	DDR3-800/1066/1333/1600	Units	NOTE
$V_{OHdiff(AC)}$	AC differential output high measurement level (for output SR)	$+0.2 \times V_{DDQ}$	V	1
$V_{OLdiff(AC)}$	AC differential output low measurement level (for output SR)	$-0.2 \times V_{DDQ}$	V	1

NOTE : 1. The swing of $\pm 0.2 \times V_{DDQ}$ is based on approximately 50% of the static single ended output high or low swing with a driver impedance of 40Ω and an effective test load of 25Ω to $V_{TT} = V_{DDQ}/2$ at each of the differential outputs.

14.3 Single-ended Output Slew Rate

With the reference load for timing measurements, output slew rate for falling and rising edges is defined and measured between $V_{OL(AC)}$ and $V_{OH(AC)}$ for single ended signals as shown in below.

[Table 12] Single ended Output slew rate definition

Description	Measured		Defined by
	From	To	
Single ended output slew rate for rising edge	$V_{OL(AC)}$	$V_{OH(AC)}$	$\frac{V_{OH(AC)}-V_{OL(AC)}}{\Delta TRse}$
Single ended output slew rate for falling edge	$V_{OH(AC)}$	$V_{OL(AC)}$	$\frac{V_{OH(AC)}-V_{OL(AC)}}{\Delta TFse}$

NOTE : Output slew rate is verified by design and characterization, and may not be subject to production test.

[Table 13] Single ended output slew rate

Parameter	Symbol	Operation Voltage	DDR3-800		DDR3-1066		DDR3-1333		DDR3-1600		Units
			Min	Max	Min	Max	Min	Max	Min	Max	
Single ended output slew rate	SRQse	1.35V	1.75	5 ¹⁾	1.75	5 ¹⁾	1.75	5 ¹⁾	1.75	5 ¹⁾	V/ns
		1.5V	2.5	5	2.5	5	2.5	5	2.5	5	V/ns

Description : SR : Slew Rate

Q : Query Output (like in DQ, which stands for Data-in, Query-Output)

se : Single-ended Signals

For Ron = RZQ/7 setting

NOTE : 1) In two cases, a maximum slew rate of 6V/ns applies for a single DQ signal within a byte lane.

- Case_1 is defined for a single DQ signal within a byte lane which is switching into a certain direction (either from high to low or low to high) while all remaining DQ signals in the same byte lane are static (i.e they stay at either high or low).
- Case_2 is defined for a single DQ signals in the same byte lane are switching into the opposite direction (i.e. from low to high or high to low respectively). For the remaining DQ signal switching into the opposite direction, the regular maximum limit of 5 V/ns applies.

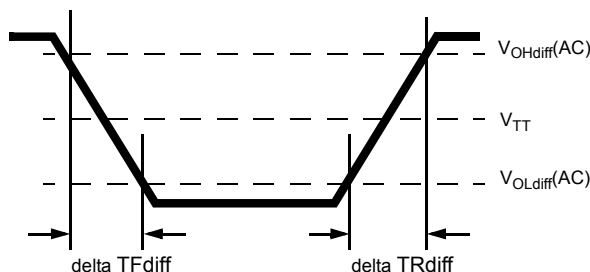

Figure 6. Single-ended output slew rate definition

14.4 Differential Output Slew Rate

With the reference load for timing measurements, output slew rate for falling and rising edges is defined and measured between $V_{OLdiff}(AC)$ and $V_{OHdiff}(AC)$ for differential signals as shown in below.

[Table 14] Differential Output slew rate definition

Description	Measured		Defined by
	From	To	
Differential output slew rate for rising edge	$V_{OLdiff}(AC)$	$V_{OHdiff}(AC)$	$\frac{V_{OHdiff}(AC)-V_{OLdiff}(AC)}{\Delta TR_{diff}}$
Differential output slew rate for falling edge	$V_{OHdiff}(AC)$	$V_{OLdiff}(AC)$	$\frac{V_{OHdiff}(AC)-V_{OLdiff}(AC)}{\Delta TF_{diff}}$

NOTE : Output slew rate is verified by design and characterization, and may not be subject to production test.

[Table 15] Differential Output slew rate

Parameter	Symbol	Operation Voltage	DDR3-800		DDR3-1066		DDR3-1333		DDR3-1600		Units
			Min	Max	Min	Max	Min	Max	Min	Max	
Differential output slew rate	SRQdiff	1.35V	3.5	12	3.5	12	3.5	12	3.5	12	V/ns
		1.5V	5	10	5	10	5	10	5	10	V/ns

Description : SR : Slew Rate

Q : Query Output (like in DQ, which stands for Data-in, Query-Output)

diff : Differential Signals

For Ron = RZQ/7 setting

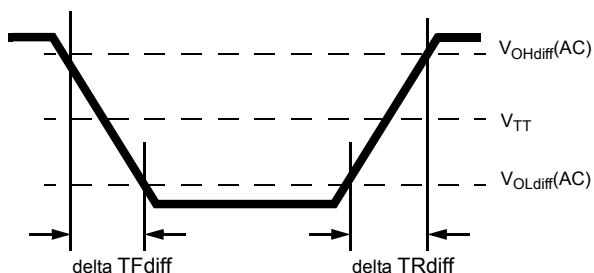

Figure 7. Differential output slew rate definition

15. IDD specification definition

Symbol	Description
IDD0	Operating One Bank Active-Precharge Current CKE: High; External clock: On; tCK, nRC, nRAS, CL: Refer to Component Datasheet for detail pattern ; BL: 8 ¹⁾ ; AL: 0; CS: High between ACT and PRE; Command, Address, Bank Address Inputs: partially toggling ; Data IO: FLOATING; DM: stable at 0; Bank Activity: Cycling with one bank active at a time: 0,0,1,1,2,2,... ; Output Buffer and RTT: Enabled in Mode Registers ²⁾ ; ODT Signal: stable at 0; Pattern Details: Refer to Component Datasheet for detail pattern
IDD1	Operating One Bank Active-Read-Precharge Current CKE: High; External clock: On; tCK, nRC, nRAS, nRCD, CL: Refer to Component Datasheet for detail pattern ; BL: 8 ¹⁾ ; AL: 0; CS: High between ACT, RD and PRE; Command, Address, Bank Address Inputs, Data IO: partially toggling ; DM: stable at 0; Bank Activity: Cycling with one bank active at a time: 0,0,1,1,2,2,... ; Output Buffer and RTT: Enabled in Mode Registers ²⁾ ; ODT Signal: stable at 0; Pattern Details: Refer to Component Datasheet for detail pattern
IDD2N	Precharge Standby Current CKE: High; External clock: On; tCK, CL: Refer to Component Datasheet for detail pattern ; BL: 8 ¹⁾ ; AL: 0; CS: stable at 1; Command, Address, Bank Address Inputs: partially toggling ; Data IO: FLOATING; DM: stable at 0; Bank Activity: all banks closed; Output Buffer and RTT: Enabled in Mode Registers ²⁾ ; ODT Signal: stable at 0; Pattern Details: Refer to Component Datasheet for detail pattern
IDD2P0	Precharge Power-Down Current Slow Exit CKE: Low; External clock: On; tCK, CL: Refer to Component Datasheet for detail pattern ; BL: 8 ¹⁾ ; AL: 0; CS: stable at 1; Command, Address, Bank Address Inputs: stable at 0; Data IO: FLOATING; DM: stable at 0; Bank Activity: all banks closed; Output Buffer and RTT: Enabled in Mode Registers ²⁾ ; ODT Signal: stable at 0; Precharge Power Down Mode: Slow Exit ³⁾
IDD2P1	Precharge Power-Down Current Fast Exit CKE: Low; External clock: On; tCK, CL: Refer to Component Datasheet for detail pattern ; BL: 8 ¹⁾ ; AL: 0; CS: stable at 1; Command, Address, Bank Address Inputs: stable at 0; Data IO: FLOATING; DM: stable at 0; Bank Activity: all banks closed; Output Buffer and RTT: Enabled in Mode Registers ²⁾ ; ODT Signal: stable at 0; Precharge Power Down Mode: Fast Exit ³⁾
IDD2Q	Precharge Quiet Standby Current CKE: High; External clock: On; tCK, CL: Refer to Component Datasheet for detail pattern ; BL: 8 ¹⁾ ; AL: 0; CS: stable at 1; Command, Address, Bank Address Inputs: stable at 0; Data IO: FLOATING; DM: stable at 0; Bank Activity: all banks closed; Output Buffer and RTT: Enabled in Mode Registers ²⁾ ; ODT Signal: stable at 0
IDD3N	Active Standby Current CKE: High; External clock: On; tCK, CL: Refer to Component Datasheet for detail pattern ; BL: 8 ¹⁾ ; AL: 0; CS: stable at 1; Command, Address, Bank Address Inputs: partially toggling ; Data IO: FLOATING; DM: stable at 0; Bank Activity: all banks open; Output Buffer and RTT: Enabled in Mode Registers ²⁾ ; ODT Signal: stable at 0; Pattern Details: Refer to Component Datasheet for detail pattern
IDD3P	Active Power-Down Current CKE: Low; External clock: On; tCK, CL: Refer to Component Datasheet for detail pattern ; BL: 8 ¹⁾ ; AL: 0; CS: stable at 1; Command, Address, Bank Address Inputs: stable at 0; Data IO: FLOATING; DM: stable at 0; Bank Activity: all banks open; Output Buffer and RTT: Enabled in Mode Registers ²⁾ ; ODT Signal: stable at 0
IDD4R	Operating Burst Read Current CKE: High; External clock: On; tCK, CL: Refer to Component Datasheet for detail pattern ; BL: 8 ¹⁾ ; AL: 0; CS: High between RD; Command, Address, Bank Address Inputs: partially toggling ; Data IO: seamless read data burst with different data between one burst and the next one ; DM: stable at 0; Bank Activity: all banks open, RD commands cycling through banks: 0,0,1,1,2,2,... ; Output Buffer and RTT: Enabled in Mode Registers ²⁾ ; ODT Signal: stable at 0; Pattern Details: Refer to Component Datasheet for detail pattern
IDD4W	Operating Burst Write Current CKE: High; External clock: On; tCK, CL: Refer to Component Datasheet for detail pattern ; BL: 8 ¹⁾ ; AL: 0; CS: High between WR; Command, Address, Bank Address Inputs: partially toggling ; Data IO: seamless write data burst with different data between one burst and the next one ; DM: stable at 0; Bank Activity: all banks open, WR commands cycling through banks: 0,0,1,1,2,2,... ; Output Buffer and RTT: Enabled in Mode Registers ²⁾ ; ODT Signal: stable at HIGH; Pattern Details: Refer to Component Datasheet for detail pattern
IDD5B	Burst Refresh Current CKE: High; External clock: On; tCK, CL, nRFC: Refer to Component Datasheet for detail pattern ; BL: 8 ¹⁾ ; AL: 0; CS: High between REF; Command, Address, Bank Address Inputs: partially toggling ; Data IO: FLOATING; DM: stable at 0; Bank Activity: REF command every nRFC ; Output Buffer and RTT: Enabled in Mode Registers ²⁾ ; ODT Signal: stable at 0; Pattern Details: Refer to Component Datasheet for detail pattern
IDD6	Self Refresh Current: Normal Temperature Range TCASE: 0 - 85°C; Auto Self-Refresh (ASR): Disabled ⁴⁾ ; Self-Refresh Temperature Range (SRT): Normal ⁵⁾ ; CKE: Low; External clock: Off; CK and CK: LOW; CL: Refer to Component Datasheet for detail pattern ; BL: 8 ¹⁾ ; AL: 0; CS, Command, Address, Bank Address, Data IO: FLOATING; DM: stable at 0; Bank Activity: Self-Refresh operation; Output Buffer and RTT: Enabled in Mode Registers ²⁾ ; ODT Signal: FLOATING
IDD6ET	Self-Refresh Current: Extended Temperature Range (optional)⁶⁾ TCASE: 0 - 95°C; Auto Self-Refresh (ASR): Disabled ⁴⁾ ; Self-Refresh Temperature Range (SRT): Extended ⁵⁾ ; CKE: Low; External clock: Off; CK and CK: LOW; CL: Refer to Component Datasheet for detail pattern ; BL: 8 ¹⁾ ; AL: 0; CS, Command, Address, Bank Address, Data IO: FLOATING; DM: stable at 0; Bank Activity: Extended Temperature Self-Refresh operation; Output Buffer and RTT: Enabled in Mode Registers ²⁾ ; ODT Signal: FLOATING
IDD7	Operating Bank Interleave Read Current CKE: High; External clock: On; tCK, nRC, nRAS, nRCD, nRRD, nFAW, CL: Refer to Component Datasheet for detail pattern ; BL: 8 ¹⁾ ; AL: CL-1; CS: High between ACT and RDA; Command, Address, Bank Address Inputs: partially toggling ; Data IO: read data bursts with different data between one burst and the next one ; DM: stable at 0; Bank Activity: two times interleaved cycling through banks (0, 1, ...7) with different addressing ; Output Buffer and RTT: Enabled in Mode Registers ²⁾ ; ODT Signal: stable at 0; Pattern Details: Refer to Component Datasheet for detail pattern
IDD8	RESET Low Current RESET : Low; External clock : off; CK and CK : LOW; CKE : FLOATING ; CS, Command, Address, Bank Address, Data IO : FLOATING ; ODT Signal : FLOATING

NOTE :

- 1) Burst Length: BL8 fixed by MRS: set MR0 A[1,0]=00B
- 2) Output Buffer Enable: set MR1 A[12] = 0B; set MR1 A[5,1] = 01B; RTT_Nom enable: set MR1 A[9,6,2] = 011B; RTT_Wr enable: set MR2 A[10,9] = 10B
- 3) Precharge Power Down Mode: set MR0 A12=0B for Slow Exit or MR0 A12=1B for Fast Exit
- 4) Auto Self-Refresh (ASR): set MR2 A6 = 0B to disable or 1B to enable feature
- 5) Self-Refresh Temperature Range (SRT): set MR2 A7=0B for normal or 1B for extended temperature range
- 6) Refer to DRAM supplier data sheet and/or DIMM SPD to determine if optional features or requirements are supported by DDR3 SDRAM device
- 7) IDD current measure method and detail patterns are described on DDR3 component datasheet
- 8) VDD and VDDQ are merged on module PCB.
- 9) DIMM IDD SPEC is measured with Qoff condition
(IDDQ values are not considered)

16. IDD SPEC Table

M392B1G70BH0 : 8GB(1Gx72) Module

Symbol	DDR3-1066		DDR3-1333		DDR3-1600		Unit	NOTE
	7-7-7		9-9-9		11-11-11			
	1.35V	1.5V	1.35V	1.5V	1.35V	1.5V		
IDD0	1330	1400	1350	1420	1370	1540	mA	
IDD1	1510	1580	1530	1600	1640	1720	mA	
IDD2P0(slow exit)	440	460	450	480	480	500	mA	
IDD2P1(fast exit)	440	460	450	480	480	500	mA	
IDD2N	950	1020	970	1040	1000	1070	mA	
IDD2Q	950	1020	960	1040	990	1070	mA	
IDD3P	440	550	540	570	570	590	mA	
IDD3N	1080	1240	1180	1260	1210	1280	mA	
IDD4R	1820	1890	2010	2090	2220	2310	mA	
IDD4W	1790	1940	2070	2150	2280	2440	mA	
IDD5B	2660	2820	3210	3290	3240	3320	mA	
IDD6	280	280	280	280	280	280	mA	
IDD7	2980	3050	3530	3610	3650	3720	mA	
IDD8	280	280	280	280	280	280	mA	

M392B1G73BH0 : 8GB(1Gx72) Module

Symbol	DDR3-1066		DDR3-1333		DDR3-1600		Unit	NOTE
	7-7-7		9-9-9		11-11-11			
	1.35V	1.5V	1.35V	1.5V	1.35V	1.5V		
IDD0	1150	1220	1170	1240	1190	1315	mA	1
IDD1	1195	1310	1260	1330	1325	1405	mA	1
IDD2P0(slow exit)	440	460	450	480	480	500	mA	
IDD2P1(fast exit)	440	460	450	480	480	500	mA	
IDD2N	950	1020	970	1040	1000	1070	mA	
IDD2Q	950	1020	960	1040	990	1070	mA	
IDD3P	440	550	540	570	570	590	mA	
IDD3N	1080	1240	1180	1260	1210	1280	mA	
IDD4R	1460	1530	1605	1685	1770	1860	mA	1
IDD4W	1475	1535	1575	1700	1785	1900	mA	1
IDD5B	1805	1920	2085	2165	2115	2195	mA	1
IDD6	280	280	280	280	280	280	mA	
IDD7	1990	2060	2315	2440	2390	2505	mA	1
IDD8	280	280	280	280	280	280	mA	

NOTE :

1. DIMM IDD SPEC is calculated with considering de-activated rank(IDLE) is IDD2N.

M392B2G70BM0 : 16GB(2Gx72) Module

Symbol	DDR3-1066		DDR3-1333		DDR3-1600		Unit	NOTE
	7-7-7		9-9-9		11-11-11			
	1.35V	1.5V	1.35V	1.5V	1.35V	1.5V		
IDD0	1690	1760	1710	1780	1730	1900	mA	1
IDD1	1780	1940	1890	1960	2000	2080	mA	1
IDD2P0(slow exit)	710	730	720	750	750	770	mA	
IDD2P1(fast exit)	710	730	720	750	750	770	mA	
IDD2N	1310	1380	1330	1400	1360	1430	mA	
IDD2Q	1310	1380	1320	1400	1350	1430	mA	
IDD3P	710	910	900	930	930	950	mA	
IDD3N	1530	1780	1720	1800	1750	1820	mA	
IDD4R	2180	2250	2370	2450	2580	2670	mA	1
IDD4W	2150	2300	2430	2510	2640	2800	mA	1
IDD5B	3020	3180	3570	3650	3600	3680	mA	1
IDD6	550	550	550	550	550	550	mA	
IDD7	3340	3410	3890	3970	4010	4080	mA	1
IDD8	550	550	550	550	550	550	mA	

NOTE :

1. DIMM IDD SPEC is calculated with considering de-activated rank(IDLE) is IDD2N.

M392B2G73BM0 : 16GB(2Gx72) Module

Symbol	DDR3-1066		DDR3-1333		Unit	NOTE
	7-7-7		9-9-9			
	1.35V	1.5V	1.35V	1.5V		
IDD0	1510	1580	1530	1600	mA	1
IDD1	1600	1670	1620	1690	mA	1
IDD2P0(slow exit)	710	730	720	750	mA	
IDD2P1(fast exit)	710	730	720	750	mA	
IDD2N	1310	1380	1330	1400	mA	
IDD2Q	1310	1380	1320	1400	mA	
IDD3P	710	910	900	930	mA	
IDD3N	1530	1780	1720	1800	mA	
IDD4R	1775	1845	1875	1955	mA	1
IDD4W	1680	1780	1810	1890	mA	1
IDD5B	2165	2280	2445	2525	mA	1
IDD6	550	550	550	550	mA	
IDD7	2350	2420	2630	2710	mA	1
IDD8	550	550	550	550	mA	

NOTE :

1. DIMM IDD SPEC is calculated with considering de-activated rank(IDLE) is IDD2N.

M392B4G70BE0 : 32GB(4Gx72) Module

Symbol	DDR3-1066		DDR3-1333		Unit	NOTE
	7-7-7		9-9-9			
	1.35V	1.5V	1.35V	1.5V		
IDD0	2410	2480	2430	2500	mA	1
IDD1	2590	2660	2610	2680	mA	1
IDD2P0(slow exit)	1520	1540	1530	1560	mA	
IDD2P1(fast exit)	1520	1540	1530	1560	mA	
IDD2N	2030	2100	2050	2120	mA	
IDD2Q	2030	2100	2040	2120	mA	
IDD3P	1520	1630	1620	1650	mA	
IDD3N	2160	2320	2260	2340	mA	
IDD4R	2900	2970	3090	3170	mA	1
IDD4W	2870	3020	3150	3230	mA	1
IDD5B	3740	3900	4290	4370	mA	1
IDD6	1360	1360	1360	1360	mA	
IDD7	4060	4130	4610	4690	mA	1
IDD8	1360	1360	1360	1360	mA	

NOTE :

1. DIMM IDD SPEC is calculated with considering de-actived rank(IDLE) is IDD2N.

17. Input/Output Capacitance

[Table 16] Input/Output Capacitance

Parameter	Symbol	DDR3-800		DDR3-1066		DDR3-1333		DDR3-1600		Units	NOTE
		Min	Max	Min	Max	Min	Max	Min	Max		
1.35V											
Input/output capacitance (DQ, DM, DQS, \overline{DQS} , TDQS, \overline{TDQS})	CIO	1.5	2.5	1.5	2.5	1.5	2.3	1.2	2.3	pF	1,2,3
Input capacitance (CK and \overline{CK})	CCK	0.8	1.6	0.8	1.6	0.8	1.4	0.8	1.4	pF	2,3
Input capacitance delta (CK and \overline{CK})	CDCK	0	0.15	0	0.15	0	0.15	0	0.15	pF	2,3,4
Input capacitance (All other input-only pins)	CI	0.75	1.3	0.75	1.3	0.75	1.3	0.75	1.3	pF	2,3,6
Input/Output capacitance delta (DQS and \overline{DQS})	CDDQS	0	0.2	0	0.2	0	0.15	0	0.15	pF	2,3,5
Input capacitance delta (All control input-only pins)	CDI_CTRL	-0.5	0.3	-0.5	0.3	-0.4	0.2	-0.4	0.2	pF	2,3,7,8
Input capacitance delta (all ADD and CMD input-only pins)	CDI_ADD_CMD	-0.5	0.5	-0.5	0.5	0.4	0.2	0.4	0.2	pF	2,3,9,10
Input/output capacitance delta (DQ, DM, DQS, \overline{DQS} , TDQS, \overline{TDQS})	CDIO	-0.5	0.3	-0.5	0.3	-0.5	0.3	-0.5	0.3	pF	2,3,11
Input/output capacitance of ZQ pin	CZQ	-	3	-	3	-	3	-	3	pF	2, 3, 12
1.5V											
Input/output capacitance (DQ, DM, DQS, \overline{DQS} , TDQS, \overline{TDQS})	CIO	1.4	3.0	1.4	2.7	1.4	2.5	1.4	2.3	pF	1,2,3
Input capacitance (CK and \overline{CK})	CCK	0.8	1.6	0.8	1.6	0.8	1.4	0.8	1.4	pF	2,3
Input capacitance delta (CK and \overline{CK})	CDCK	0	0.15	0	0.15	0	0.15	0	0.15	pF	2,3,4
Input capacitance (All other input-only pins)	CI	0.75	1.4	0.75	1.35	0.75	1.3	0.75	1.3	pF	2,3,6
Input capacitance delta (DQS and \overline{DQS})	CDDQS	0	0.2	0	0.2	0	0.15	0	0.15	pF	2,3,5
Input capacitance delta (All control input-only pins)	CDI_CTRL	-0.5	0.3	-0.5	0.3	-0.4	0.2	-0.4	0.2	pF	2,3,7,8
Input capacitance delta (all ADD and CMD input-only pins)	CDI_ADD_CMD	-0.5	0.5	-0.5	0.5	-0.4	0.4	-0.4	0.4	pF	2,3,9,10
Input/output capacitance delta (DQ, DM, DQS, \overline{DQS} , TDQS, \overline{TDQS})	CDIO	-0.5	0.3	-0.5	0.3	-0.5	0.3	-0.5	0.3	pF	2,3,11
Input/output capacitance of ZQ pin	CZQ	-	3	-	3	-	3	-	3	pF	2, 3, 12

NOTE : This parameter is Component Input/Output Capacitance so that is different from Module level Capacitance.

- Although the DM, TDQS and \overline{TDQS} pins have different functions, the loading matches DQ and DQS
- This parameter is not subject to production test. It is verified by design and characterization.
The capacitance is measured according to JEP147 ("PROCEDURE FOR MEASURING INPUT CAPACITANCE USING A VECTOR NETWORK ANALYZER (VNA)") with V_{DD} , V_{DDQ} , V_{SS} , V_{SSQ} applied and all other pins floating (except the pin under test, CKE, RESET and ODT as necessary). $V_{DD}=V_{DDQ}=1.5V$ or $1.35V$, $V_{BIAS}=V_{DD}/2$ and on-die termination off.
- This parameter applies to monolithic devices only; stacked/dual-die devices are not covered here
- Absolute value of CCK-CCK
- Absolute value of CIO(DQS)-CIO(\overline{DQS})
- CI applies to ODT, \overline{CS} , CKE, A0-A15, BA0-BA2, \overline{RAS} , \overline{CAS} , \overline{WE} .
- CDI_CTRL applies to ODT, \overline{CS} and CKE
- CDI_CTRL=CI(CTRL)-0.5*(CI(CLK)+CI(\overline{CLK}))
- CDI_ADD_CMD applies to A0-A15, BA0-BA2, \overline{RAS} , \overline{CAS} and \overline{WE}
- CDI_ADD_CMD=CI(ADD_CMD) - 0.5*(CI(CLK)+CI(\overline{CLK}))
- CDIO=CIO(DQ,DM) - 0.5*(CIO(DQS)+CIO(\overline{DQS}))
- Maximum external load capacitance on ZQ pin: 5pF

18. Electrical Characteristics and AC timing

[0 °C < T_{CASE} ≤ 95 °C, V_{DDQ} = 1.35V(1.28V~1.45V) & 1.5V(1.425V~1.575V); V_{DD} = 1.35V(1.28V~1.45V) & 1.5V(1.425V~1.575V)]

18.1 Refresh Parameters by Device Density

Parameter	Symbol	1Gb	2Gb	4Gb	8Gb	Units	NOTE	
All Bank Refresh to active/refresh cmd time	tRFC	110	160	260	350	ns		
Average periodic refresh interval	tREFI	0 °C ≤ T _{CASE} ≤ 85°C	7.8	7.8	7.8	7.8	μs	
		85 °C < T _{CASE} ≤ 95°C	3.9	3.9	3.9	3.9	μs	1

NOTE :

1. Users should refer to the DRAM supplier data sheet and/or the DIMM SPD to determine if DDR3 SDRAM devices support the following options or requirements referred to in this material.

18.2 Speed Bins and CL, tRCD, tRP, tRC and tRAS for Corresponding Bin

Speed	DDR3-800	DDR3-1066	DDR3-1333	DDR3-1600	Units	NOTE
Bin (CL - tRCD - tRP)	6-6-6	7-7-7	9-9-9	11-11-11		
Parameter	min	min	min	min		
CL	6	7	9	11	tCK	
tRCD	15	13.13	13.5	13.75	ns	
tRP	15	13.13	13.5	13.75	ns	
tRAS	37.5	37.5	36	35	ns	
tRC	52.5	50.63	49.5	48.75	ns	
tRRD	10	7.5	6.0	6.0	ns	
tFAW	40	37.5	30	30	ns	

18.3 Speed Bins and CL, tRCD, tRP, tRC and tRAS for Corresponding Bin

DDR3 SDRAM Speed Bins include tCK, tRCD, tRP, tRAS and tRC for each corresponding bin.

[Table 17] DDR3-800 Speed Bins

Speed		DDR3-800		Units	NOTE
CL-nRCD-nRP		6 - 6 - 6			
Parameter	Symbol	min	max		
Internal read command to first data	tAA	15	20	ns	
ACT to internal read or write delay time	tRCD	15	-	ns	
PRE command period	tRP	15	-	ns	
ACT to ACT or REF command period	tRC	52.5	-	ns	
ACT to PRE command period	tRAS	37.5	9*tREFI	ns	
CL = 6 / CWL = 5	tCK(AVG)	2.5	3.3	ns	1,2,3
Supported CL Settings		6		nCK	
Supported CWL Settings		5		nCK	

[Table 18] DDR3-1066 Speed Bins

Speed		DDR3-1066		Units	NOTE	
CL-nRCD-nRP		7 - 7 - 7				
Parameter	Symbol	min	max			
Internal read command to first data		tAA	13.125	20	ns	
ACT to internal read or write delay time		tRCD	13.125	-	ns	
PRE command period		tRP	13.125	-	ns	
ACT to ACT or REF command period		tRC	50.625	-	ns	
ACT to PRE command period		tRAS	37.5	9*tREFI	ns	
CL = 6	CWL = 5	tCK(AVG)	2.5	3.3	ns	1,2,3,5
	CWL = 6	tCK(AVG)	Reserved		ns	1,2,3,4
CL = 7	CWL = 5	tCK(AVG)	Reserved		ns	4
	CWL = 6	tCK(AVG)	1.875	<2.5	ns	1,2,3,4,8
CL = 8	CWL = 5	tCK(AVG)	Reserved		ns	4
	CWL = 6	tCK(AVG)	1.875	<2.5	ns	1,2,3
Supported CL Settings		6,7,8		nCK		
Supported CWL Settings		5,6		nCK		

[Table 19] DDR3-1333 Speed Bins

Speed		DDR3-1333		Units	NOTE	
CL-nRCD-nRP		9 - 9 - 9				
Parameter	Symbol	min	max			
Internal read command to first data		tAA	13.5 (13.125) ⁸	20	ns	
ACT to internal read or write delay time		tRCD	13.5 (13.125) ⁸	-	ns	
PRE command period		tRP	13.5 (13.125) ⁸	-	ns	
ACT to ACT or REF command period		tRC	49.5 (49.125) ⁸	-	ns	
ACT to PRE command period		tRAS	36	9*tREFI	ns	
CL = 6	CWL = 5	tCK(AVG)	2.5	3.3	ns	1,2,3,6
	CWL = 6	tCK(AVG)	Reserved		ns	1,2,3,4,6
	CWL = 7	tCK(AVG)	Reserved		ns	4
CL = 7	CWL = 5	tCK(AVG)	Reserved		ns	4
	CWL = 6	tCK(AVG)	1.875	<2.5	ns	1,2,3,4,6
	CWL = 7	tCK(AVG)	Reserved		ns	1,2,3,4
CL = 8	CWL = 5	tCK(AVG)	Reserved		ns	4
	CWL = 6	tCK(AVG)	1.875	<2.5	ns	1,2,3,6
	CWL = 7	tCK(AVG)	Reserved		ns	1,2,3,4
CL = 9	CWL = 5,6	tCK(AVG)	Reserved		ns	4
	CWL = 7	tCK(AVG)	1.5	<1.875	ns	1,2,3,4,8
CL = 10	CWL = 5,6	tCK(AVG)	Reserved		ns	4
	CWL = 7	tCK(AVG)	Reserved		ns	1,2,3
Supported CL Settings		6,7,8,9		nCK		
Supported CWL Settings		5,6,7		nCK		

[Table 20] DDR3-1600 Speed Bins

Speed		DDR3-1600		Units	NOTE	
CL-nRCD-nRP		11-11-11				
Parameter	Symbol	min	max			
Internal read command to first data	tAA	13.75 (13.125) ⁸	20	ns		
ACT to internal read or write delay time	tRCD	13.75 (13.125) ⁸	-	ns		
PRE command period	tRP	13.75 (13.125) ⁸	-	ns		
ACT to ACT or REF command period	tRC	48.75 (48.125) ⁸	-	ns		
ACT to PRE command period	tRAS	35	9*tREFI	ns		
CL = 6	CWL = 5	tCK(AVG)	2.5	3.3	ns	1,2,3,7
	CWL = 6	tCK(AVG)	Reserved		ns	1,2,3,4,7
	CWL = 7, 8	tCK(AVG)	Reserved		ns	4
CL = 7	CWL = 5	tCK(AVG)	Reserved		ns	4
	CWL = 6	tCK(AVG)	1.875	<2.5	ns	1,2,3,4,7
	CWL = 7	tCK(AVG)	Reserved		ns	1,2,3,4,7
	CWL = 8	tCK(AVG)	Reserved		ns	4
CL = 8	CWL = 5	tCK(AVG)	Reserved		ns	4
	CWL = 6	tCK(AVG)	1.875	<2.5	ns	1,2,3,7
	CWL = 7	tCK(AVG)	Reserved		ns	1,2,3,4,7
	CWL = 8	tCK(AVG)	Reserved		ns	1,2,3,4
CL = 9	CWL = 5,6	tCK(AVG)	Reserved		ns	4
	CWL = 7	tCK(AVG)	1.5	<1.875	ns	1,2,3,4,7
	CWL = 8	tCK(AVG)	Reserved		ns	1,2,3,4
CL = 10	CWL = 5,6	tCK(AVG)	Reserved		ns	4
	CWL = 7	tCK(AVG)	1.5	<1.875	ns	1,2,3,7
	CWL = 8	tCK(AVG)	Reserved		ns	1,2,3,4
CL = 11	CWL = 5,6,7	tCK(AVG)	Reserved		ns	4
	CWL = 8	tCK(AVG)	1.25	<1.5	ns	1,2,3,8
Supported CL Settings		6,7,8,9,10,11		nCK		
Supported CWL Settings		5,6,7,8		nCK		

18.3.1 Speed Bin Table Notes

Absolute Specification [T_{OPER} ; $V_{DDQ} = V_{DD} = 1.35V(1.28V\sim 1.45V) \& 1.5V(1.425V\sim 1.575V)$];

NOTE :

1. The CL setting and CWL setting result in tCK(AVG).MIN and tCK(AVG).MAX requirements. When making a selection of tCK(AVG), both need to be fulfilled: Requirements from CL setting as well as requirements from CWL setting.
2. tCK(AVG).MIN limits: Since CAS Latency is not purely analog - data and strobe output are synchronized by the DLL - all possible intermediate frequencies may not be guaranteed. An application should use the next smaller JEDEC standard tCK(AVG) value (2.5, 1.875, 1.5, or 1.25 ns) when calculating CL [nCK] = tAA [ns] / tCK(AVG) [ns], rounding up to the next "SupportedCL".
3. tCK(AVG).MAX limits: Calculate tCK(AVG) = tAA.MAX / CL SELECTED and round the resulting tCK(AVG) down to the next valid speed bin (i.e. 3.3ns or 2.5ns or 1.875 ns or 1.25 ns). This result is tCK(AVG).MAX corresponding to CL SELECTED.
4. "Reserved" settings are not allowed. User must program a different value.
5. Any DDR3-1066 speed bin also supports functional operation at lower frequencies as shown in the table which are not subject to Production Tests but verified by Design/Characterization.
6. Any DDR3-1333 speed bin also supports functional operation at lower frequencies as shown in the table which are not subject to Production Tests but verified by Design/Characterization.
7. Any DDR3-1600 speed bin also supports functional operation at lower frequencies as shown in the table which are not subject to Production Tests but verified by Design/Characterization.
8. For devices supporting optional downshift to CL=7 and CL=9, tAA/tRCD/tRP min must be 13.125 ns or lower. SPD settings must be programmed to match. For example, DDR3-1333(CL9) devices supporting downshift to DDR3-1066(CL7) should program 13.125 ns in SPD bytes for tAAmin (Byte 16), tRCDmin (Byte 18), and tRPmin (Byte 20). DDR3-1600(CL11) devices supporting downshift to DDR3-1333(CL9) or DDR3-1066(CL7) should program 13.125 ns in SPD bytes for tAAmin (Byte16), tRCDmin (Byte 18), and tRPmin (Byte 20). Once tRP (Byte 20) is programmed to 13.125ns, tRCmin (Byte 21,23) also should be programmed accordingly. For example, 49.125ns (tRASmin + tRPmin=36ns+13.125ns) for DDR3-1333(CL9) and 48.125ns (tRASmin+tRPmin=35ns+13.125ns) for DDR3-1600(CL11).

19. Timing Parameters by Speed Grade

[Table 21] Timing Parameters by Speed Bin (Cont.)

Speed		DDR3-800		DDR3-1066		DDR3-1333		DDR3-1600		Units	NOTE
Parameter	Symbol	MIN	MAX	MIN	MAX	MIN	MAX	MIN	MAX		
Clock Timing											
Minimum Clock Cycle Time (DLL off mode)	tCK(DLL_OFF)	8	-	8	-	8	-	8	-	ns	6
Average Clock Period	tCK(avg)	See Speed Bins Table								ps	
Clock Period	tCK(abs)	tCK(avg)min + tJIT(per)min	tCK(avg)max + tJIT(per)max	tCK(avg)min + tJIT(per)min	tCK(avg)max + tJIT(per)max	tCK(avg)min + tJIT(per)min	tCK(avg)max + tJIT(per)max	tCK(avg)min + tJIT(per)min	tCK(avg)max + tJIT(per)max	ps	
Average high pulse width	tCH(avg)	0.47	0.53	0.47	0.53	0.47	0.53	0.47	0.53	tCK(avg)	
Average low pulse width	tCL(avg)	0.47	0.53	0.47	0.53	0.47	0.53	0.47	0.53	tCK(avg)	
Clock Period Jitter	tJIT(per)	-100	100	-90	90	-80	80	-70	70	ps	
Clock Period Jitter during DLL locking period	tJIT(per, lck)	-90	90	-80	80	-70	70	-60	60	ps	
Cycle to Cycle Period Jitter	tJIT(cc)	200		180		160		140		ps	
Cycle to Cycle Period Jitter during DLL locking period	tJIT(cc, lck)	180		160		140		120		ps	
Cumulative error across 2 cycles	tERR(2per)	-147	147	-132	132	-118	118	-103	103	ps	
Cumulative error across 3 cycles	tERR(3per)	-175	175	-157	157	-140	140	-122	122	ps	
Cumulative error across 4 cycles	tERR(4per)	-194	194	-175	175	-155	155	-136	136	ps	
Cumulative error across 5 cycles	tERR(5per)	-209	209	-188	188	-168	168	-147	147	ps	
Cumulative error across 6 cycles	tERR(6per)	-222	222	-200	200	-177	177	-155	155	ps	
Cumulative error across 7 cycles	tERR(7per)	-232	232	-209	209	-186	186	-163	163	ps	
Cumulative error across 8 cycles	tERR(8per)	-241	241	-217	217	-193	193	-169	169	ps	
Cumulative error across 9 cycles	tERR(9per)	-249	249	-224	224	-200	200	-175	175	ps	
Cumulative error across 10 cycles	tERR(10per)	-257	257	-231	231	-205	205	-180	180	ps	
Cumulative error across 11 cycles	tERR(11per)	-263	263	-237	237	-210	210	-184	184	ps	
Cumulative error across 12 cycles	tERR(12per)	-269	269	-242	242	-215	215	-188	188	ps	
Cumulative error across n = 13, 14 ... 49, 50 cycles	tERR(nper)	tERR(nper)min = (1 + 0.68ln(n))*tJIT(per)min tERR(nper)max = (1 + 0.68ln(n))*tJIT(per)max								ps	24
Absolute clock HIGH pulse width	tCH(abs)	0.43	-	0.43	-	0.43	-	0.43	-	tCK(avg)	25
Absolute clock Low pulse width	tCL(abs)	0.43	-	0.43	-	0.43	-	0.43	-	tCK(avg)	26
Data Timing											
DQS, \overline{DQS} to DQ skew, per group, per access	tDQSQ	-	200	-	150	-	125	-	100	ps	13
DQ output hold time from DQS, \overline{DQS}	tQH	0.38	-	0.38	-	0.38	-	0.38	-	tCK(avg)	13, g
DQ low-impedance time from CK, \overline{CK}	tLZ(DQ)	-800	400	-600	300	-500	250	-450	225	ps	13,14, f
DQ high-impedance time from CK, \overline{CK}	tHZ(DQ)	-	400	-	300	-	250	-	225	ps	13,14, f
Data setup time to DQS, \overline{DQS} referenced to $V_{IH}(AC)V_{IL}(AC)$ levels	1.35V										
	tDS(base) AC160	90	-	40	-	-	-	-	-	ps	d, 17
	1.5V										
	tDS(base) AC175	75	-	25	-	-	-	-	-	ps	d, 17
Data hold time from DQS, \overline{DQS} referenced to $V_{IH}(DC)V_{IL}(DC)$ levels	1.35V										
	tDH(base) DC90	160	-	110	-	75	-	55	-	ps	d, 17
	1.5V										
	tDH(base) DC100	150	-	100	-	65	-	45	-	ps	d, 17
Data setup time to DQS, \overline{DQS} referenced to $V_{IH}(AC)V_{IL}(AC)$ levels	1.35V										
	tDS(base) AC135	140	-	90	-	45	-	25	-	ps	
	1.5V										
	tDS(base) AC150	125	-	75	-	30	-	10	-	ps	
DQ and DM Input pulse width for each input	tDIPW	600	-	490	-	400	-	360	-	ps	28



[Table 21] Timing Parameters by Speed Bin (Cont.)

Speed		DDR3-800		DDR3-1066		DDR3-1333		DDR3-1600		Units	NOTE
Parameter	Symbol	MIN	MAX	MIN	MAX	MIN	MAX	MIN	MAX		
Data Strobe Timing											
DQS, $\overline{\text{DQS}}$ differential READ Preamble	tRPRE	0.9	Note 19	0.9	Note 19	0.9	Note 19	0.9	Note 19	tCK	13, 19, g
DQS, $\overline{\text{DQS}}$ differential READ Postamble	tRPST	0.3	Note 11	0.3	Note 11	0.3	Note 11	0.3	Note 11	tCK	11, 13, b
DQS, $\overline{\text{DQS}}$ differential output high time	tQSH	0.38	-	0.38	-	0.4	-	0.4	-	tCK(avg)	13, g
DQS, $\overline{\text{DQS}}$ differential output low time	tQSL	0.38	-	0.38	-	0.4	-	0.4	-	tCK(avg)	13, g
DQS, $\overline{\text{DQS}}$ differential WRITE Preamble	tWPRE	0.9	-	0.9	-	0.9	-	0.9	-	tCK	
DQS, $\overline{\text{DQS}}$ differential WRITE Postamble	tWPST	0.3	-	0.3	-	0.3	-	0.3	-	tCK	
DQS, $\overline{\text{DQS}}$ rising edge output access time from rising CK, $\overline{\text{CK}}$	tDQSCK	-400	400	-300	300	-255	255	-225	225	ps	13, f
DQS, $\overline{\text{DQS}}$ low-impedance time (Referenced from RL-1)	tLZ(DQS)	-800	400	-600	300	-500	250	-450	225	ps	13, 14, f
DQS, $\overline{\text{DQS}}$ high-impedance time (Referenced from RL+BL/2)	tHZ(DQS)	-	400	-	300	-	250	-	225	ps	12, 13, 14
DQS, $\overline{\text{DQS}}$ differential input low pulse width	tDQSL	0.45	0.55	0.45	0.55	0.45	0.55	0.45	0.55	tCK	29, 31
DQS, $\overline{\text{DQS}}$ differential input high pulse width	tDQSH	0.45	0.55	0.45	0.55	0.45	0.55	0.45	0.55	tCK	30, 31
DQS, $\overline{\text{DQS}}$ rising edge to CK, $\overline{\text{CK}}$ rising edge	tDQSS	-0.25	0.25	-0.25	0.25	-0.25	0.25	-0.27	0.27	tCK(avg)	c
DQS, $\overline{\text{DQS}}$ falling edge setup time to CK, $\overline{\text{CK}}$ rising edge	tDSS	0.2	-	0.2	-	0.2	-	0.18	-	tCK(avg)	c, 32
DQS, $\overline{\text{DQS}}$ falling edge hold time to CK, $\overline{\text{CK}}$ rising edge	tDSH	0.2	-	0.2	-	0.2	-	0.18	-	tCK(avg)	c, 32
Command and Address Timing											
DLL locking time	tDLLK	512	-	512	-	512	-	512	-	nCK	
internal READ Command to PRECHARGE Command delay	tRTP	max (4nCK, 7.5ns)	-	max (4nCK, 7.5ns)	-	max (4nCK, 7.5ns)	-	max (4nCK, 7.5ns)	-		e
Delay from start of internal write transaction to internal read command	tWTR	max (4nCK, 7.5ns)	-	max (4nCK, 7.5ns)	-	max (4nCK, 7.5ns)	-	max (4nCK, 7.5ns)	-		e, 18
WRITE recovery time	tWR	15	-	15	-	15	-	15	-	ns	e
Mode Register Set command cycle time	tMRD	4	-	4	-	4	-	4	-	nCK	
Mode Register Set command update delay	tMOD	max (12nCK, 15ns)	-	max (12nCK, 15ns)	-	max (12nCK, 15ns)	-	max (12nCK, 15ns)	-		
$\overline{\text{CAS}}$ to $\overline{\text{CAS}}$ command delay	tCCD	4	-	4	-	4	-	4	-	nCK	
Auto precharge write recovery + precharge time	tDAL(min)	WR + roundup (tRP / tCK(AVG))								nCK	
Multi-Purpose Register Recovery Time	tMPRR	1	-	1	-	1	-	1	-	nCK	22
ACTIVE to PRECHARGE command period	tRAS	See "Speed Bins and CL, tRCD, tRP, tRC and tRAS for corresponding Bin"								ns	e
ACTIVE to ACTIVE command period for 1KB page size	tRRD	max (4nCK, 10ns)	-	max (4nCK, 7.5ns)	-	max (4nCK, 6ns)	-	max (4nCK, 6ns)	-		e
ACTIVE to ACTIVE command period for 2KB page size	tRRD	max (4nCK, 10ns)	-	max (4nCK, 10ns)	-	max (4nCK, 7.5ns)	-	max (4nCK, 7.5ns)	-		e
Four activate window for 1KB page size	tFAW	40	-	37.5	-	30	-	30	-	ns	e
Four activate window for 2KB page size	tFAW	50	-	50	-	45	-	40	-	ns	e
Command and Address setup time to CK, $\overline{\text{CK}}$ referenced to $V_{IH}(AC)$ / $V_{IL}(AC)$ levels	1.35V										
	tIS(base) AC160	215	-	140	-	80	-	60	-	ps	b, 16
Command and Address hold time from CK, $\overline{\text{CK}}$ referenced to $V_{IH}(DC)$ / $V_{IL}(DC)$ levels	1.5V										
	tIS(base) AC175	200	-	125	-	65	-	45	-	ps	b, 16
Command and Address hold time from CK, $\overline{\text{CK}}$ referenced to $V_{IH}(DC)$ / $V_{IL}(DC)$ levels	1.35V										
	tIH(base) DC90	285	-	210	-	150	-	130	-	ps	b, 16
Command and Address setup time to CK, $\overline{\text{CK}}$ referenced to $V_{IH}(AC)$ / $V_{IL}(AC)$ levels	1.5V										
	tIH(base) DC100	275	-	200	-	140	-	120	-	ps	b, 16
Command and Address setup time to CK, $\overline{\text{CK}}$ referenced to $V_{IH}(AC)$ / $V_{IL}(AC)$ levels	1.35V										
	tIS(base) AC135	365	-	290	-	205	-	185	-	ps	b, 16, 27
Control & Address Input pulse width for each input	1.5V										
	tIS(base) AC150	350	-	275	-	190	-	170	-	ps	b, 16, 27
Control & Address Input pulse width for each input	tIPW	900	-	780	-	620	-	560	-	ps	28
Calibration Timing											
Power-up and RESET calibration time	tZQinitl	512	-	512	-	512	-	512	-	nCK	
Normal operation Full calibration time	tZQoper	256	-	256	-	256	-	256	-	nCK	
Normal operation short calibration time	tZQCS	64	-	64	-	64	-	64	-	nCK	23

[Table 21] Timing Parameters by Speed Bin

Speed		DDR3-800		DDR3-1066		DDR3-1333		DDR3-1600		Units	NOTE
Parameter	Symbol	MIN	MAX	MIN	MAX	MIN	MAX	MIN	MAX		
Reset Timing											
Exit Reset from CKE HIGH to a valid command	tXPR	max(5nCK, tRFC + 10ns)	-	max(5nCK, tRFC + 10ns)	-	max(5nCK, tRFC + 10ns)	-	max(5nCK, tRFC + 10ns)	-		
Self Refresh Timing											
Exit Self Refresh to commands not requiring a locked DLL	tXS	max(5nCK, tRFC + 10ns)	-	max(5nCK, tRFC + 10ns)	-	max(5nCK, tRFC + 10ns)	-	max(5nCK, tRFC + 10ns)	-		
Exit Self Refresh to commands requiring a locked DLL	tXSDLL	tDLLK(min)	-	tDLLK(min)	-	tDLLK(min)	-	tDLLK(min)	-	nCK	
Minimum CKE low width for Self refresh entry to exit timing	tCKESR	tCKE(min) + t1CK	-	tCKE(min) + t1CK	-	tCKE(min) + t1CK	-	tCKE(min) + t1CK	-		
Valid Clock Requirement after Self Refresh Entry (SRE) or Power-Down Entry (PDE)	tCKSRE	max(5nCK, 10ns)	-	max(5nCK, 10ns)	-	max(5nCK, 10ns)	-	max(5nCK, 10ns)	-		
Valid Clock Requirement before Self Refresh Exit (SRX) or Power-Down Exit (PDX) or Reset Exit	tCKSRX	max(5nCK, 10ns)	-	max(5nCK, 10ns)	-	max(5nCK, 10ns)	-	max(5nCK, 10ns)	-		
Power Down Timing											
Exit Power Down with DLL on to any valid command; Exit Precharge Power Down with DLL frozen to commands not requiring a locked DLL	tXP	max(3nCK, 7.5ns)	-	max(3nCK, 7.5ns)	-	max(3nCK, 6ns)	-	max(3nCK, 6ns)	-		
Exit Precharge Power Down with DLL frozen to commands requiring a locked DLL	tXPDLL	max(10nCK, 24ns)	-	max(10nCK, 24ns)	-	max(10nCK, 24ns)	-	max(10nCK, 24ns)	-		2
CKE minimum pulse width	tCKE	max(3nCK, 7.5ns)	-	max(3nCK, 5.625ns)	-	max(3nCK, 5.625ns)	-	max(3nCK, 5ns)	-		
Command pass disable delay	tCPDED	1	-	1	-	1	-	1	-	nCK	
Power Down Entry to Exit Timing	tPD	tCKE(min)	9*tREFI	tCKE(min)	9*tREFI	tCKE(min)	9*tREFI	tCKE(min)	9*tREFI	tCK	15
Timing of ACT command to Power Down entry	tACTPDEN	1	-	1	-	1	-	1	-	nCK	20
Timing of PRE command to Power Down entry	tPRPDEN	1	-	1	-	1	-	1	-	nCK	20
Timing of RD/RDA command to Power Down entry	tRDPDEN	RL + 4 + 1	-	RL + 4 + 1	-	RL + 4 + 1	-	RL + 4 + 1	-		
Timing of WR command to Power Down entry (BL8OTF, BL8MRS, BC4OTF)	tWRPDEN	WL + 4 + (tWR/ tCK(avg))	-	WL + 4 + (tWR/ tCK(avg))	-	WL + 4 + (tWR/ tCK(avg))	-	WL + 4 + (tWR/ tCK(avg))	-	nCK	9
Timing of WRA command to Power Down entry (BL8OTF, BL8MRS, BC4OTF)	tWRAPDEN	WL + 4 + WR + 1	-	WL + 4 + WR + 1	-	WL + 4 + WR + 1	-	WL + 4 + WR + 1	-	nCK	10
Timing of WR command to Power Down entry (BC4MRS)	tWRPDEN	WL + 2 + (tWR/ tCK(avg))	-	WL + 2 + (tWR/ tCK(avg))	-	WL + 2 + (tWR/ tCK(avg))	-	WL + 2 + (tWR/ tCK(avg))	-	nCK	9
Timing of WRA command to Power Down entry (BC4MRS)	tWRAPDEN	WL + 2 + WR + 1	-	WL + 2 + WR + 1	-	WL + 2 + WR + 1	-	WL + 2 + WR + 1	-	nCK	10
Timing of REF command to Power Down entry	tREFPDEN	1	-	1	-	1	-	1	-		20,21
Timing of MRS command to Power Down entry	tMRSPDEN	tMOD(min)	-	tMOD(min)	-	tMOD(min)	-	tMOD(min)	-		
ODT Timing											
ODT high time without write command or with write command and BC4	ODTH4	4	-	4	-	4	-	4	-	nCK	
ODT high time with Write command and BL8	ODTH8	6	-	6	-	6	-	6	-	nCK	
Asynchronous RTT turn-on delay (Power-Down with DLL frozen)	tAONPD	2	8.5	2	8.5	2	8.5	2	8.5	ns	
Asynchronous RTT turn-off delay (Power-Down with DLL frozen)	tAOPFD	2	8.5	2	8.5	2	8.5	2	8.5	ns	
RTT turn-on	tAON	-400	400	-300	300	-250	250	-225	225	ps	7,f
RTT_NOM and RTT_WR turn-off time from ODTLoff reference	tAOF	0.3	0.7	0.3	0.7	0.3	0.7	0.3	0.7	tCK(avg)	8,f
RTT dynamic change skew	tADC	0.3	0.7	0.3	0.7	0.3	0.7	0.3	0.7	tCK(avg)	f
Write Leveling Timing											
First DQS/DQS rising edge after write leveling mode is programmed	tWLMRD	40	-	40	-	40	-	40	-	tCK	3
DQS/DQS delay after write leveling mode is programmed	tWLDQSEN	25	-	25	-	25	-	25	-	tCK	3
Write leveling setup time from rising CK, CK crossing to rising DQS, DQS crossing	tWLH	325	-	245	-	195	-	165	-	ps	
Write leveling hold time from rising DQS, DQS crossing to rising CK, CK crossing	tWLH	325	-	245	-	195	-	165	-	ps	
Write leveling output delay	tWLO	0	9	0	9	0	9	0	7.5	ns	
Write leveling output error	tWLOE	0	2	0	2	0	2	0	2	ns	

19.1 Jitter Notes

- Specific Note a** Unit 'tCK(avg)' represents the actual tCK(avg) of the input clock under operation. Unit 'nCK' represents one clock cycle of the input clock, counting the actual clock edges.ex) tMRD = 4 [nCK] means; if one Mode Register Set command is registered at Tm, another Mode Register Set command may be registered at Tm+4, even if (Tm+4 - Tm) is 4 x tCK(avg) + tERR(4per),min.
- Specific Note b** These parameters are measured from a command/address signal (CKE, $\overline{\text{CS}}$, $\overline{\text{RAS}}$, $\overline{\text{CAS}}$, $\overline{\text{WE}}$, ODT, BA0, A0, A1, etc.) transition edge to its respective clock signal (CK/ $\overline{\text{CK}}$) crossing. The spec values are not affected by the amount of clock jitter applied (i.e. tJIT(per), tJIT(cc), etc.), as the setup and hold are relative to the clock signal crossing that latches the command/address. That is, these parameters should be met whether clock jitter is present or not.
- Specific Note c** These parameters are measured from a data strobe signal (DQS, $\overline{\text{DQS}}$) crossing to its respective clock signal (CK, $\overline{\text{CK}}$) crossing. The spec values are not affected by the amount of clock jitter applied (i.e. tJIT(per), tJIT(cc), etc.), as these are relative to the clock signal crossing. That is, these parameters should be met whether clock jitter is present or not.
- Specific Note d** These parameters are measured from a data signal (DM, DQ0, DQ1, etc.) transition edge to its respective data strobe signal (DQS, $\overline{\text{DQS}}$) crossing.
- Specific Note e** For these parameters, the DDR3 SDRAM device supports tPARAM [nCK] = RU{ tPARAM [ns] / tCK(avg) [ns] }, which is in clock cycles, assuming all input clock jitter specifications are satisfied. For example, the device will support tRP = RU{tRP / tCK(avg)}, which is in clock cycles, if all input clock jitter specifications are met. This means: For DDR3-800 6-6-6, of which tRP = 15ns, the device will support tRP = RU{tRP / tCK(avg)} = 6, as long as the input clock jitter specifications are met, i.e. Precharge command at Tm and Active command at Tm+6 is valid even if (Tm+6 - Tm) is less than 15ns due to input clock jitter.
- Specific Note f** When the device is operated with input clock jitter, this parameter needs to be derated by the actual tERR(mper),act of the input clock, where 2 <= m <= 12. (output deratings are relative to the SDRAM input clock.)
For example, if the measured jitter into a DDR3-800 SDRAM has tERR(mper),act,min = - 172 ps and tERR(mper),act,max = + 193 ps, then tDQSCK,min(derated) = tDQSCK,min - tERR(mper),act,max = - 400 ps - 193 ps = - 593 ps and tDQSCK,max(derated) = tDQSCK,max - tERR(mper),act,min = 400 ps + 172 ps = + 572 ps. Similarly, tLZ(DQ) for DDR3-800 derates to tLZ(DQ),min(derated) = - 800 ps - 193 ps = - 993 ps and tLZ(DQ),max(derated) = 400 ps + 172 ps = + 572 ps. (Caution on the min/max usage!)
Note that tERR(mper),act,min is the minimum measured value of tERR(nper) where 2 <= n <= 12, and tERR(mper),act,max is the maximum measured value of tERR(nper) where 2 <= n <= 12.
- Specific Note g** When the device is operated with input clock jitter, this parameter needs to be derated by the actual tJIT(per),act of the input clock. (output deratings are relative to the SDRAM input clock.) For example, if the measured jitter into a DDR3-800 SDRAM has tCK(avg),act = 2500 ps, tJIT(per),act,min = - 72 ps and tJIT(per),act,max = + 93 ps, then tRPRE,min(derated) = tRPRE,min + tJIT(per),act,min = 0.9 x tCK(avg),act + tJIT(per),act,min = 0.9 x 2500 ps - 72 ps = + 2178 ps. Similarly, tQH,min(derated) = tQH,min + tJIT(per),act,min = 0.38 x tCK(avg),act + tJIT(per),act,min = 0.38 x 2500 ps - 72 ps = + 878 ps. (Caution on the min/max usage!)

19.2 Timing Parameter Notes

- Actual value dependant upon measurement level definitions which are TBD.
- Commands requiring a locked DLL are: READ (and RAP) and synchronous ODT commands.
- The max values are system dependent.
- WR as programmed in mode register
- Value must be rounded-up to next higher integer value
- There is no maximum cycle time limit besides the need to satisfy the refresh interval, tREFI.
- For definition of RTT turn-on time tAON see "Device Operation & Timing Diagram Datasheet"
- For definition of RTT turn-off time tAOF see "Device Operation & Timing Diagram Datasheet".
- tWR is defined in ns, for calculation of tWRPDEN it is necessary to round up tWR / tCK to the next integer.
- WR in clock cycles as programmed in MR0
- The maximum read postamble is bound by tDQSCk(min) plus tQSH(min) on the left side and tHZ(DQS)max on the right side. See "Device Operation & Timing Diagram Datasheet.
- Output timing deratings are relative to the SDRAM input clock. When the device is operated with input clock jitter, this parameter needs to be derated by TBD
- Value is only valid for RON34
- Single ended signal parameter. Refer to chapter 8 and chapter 9 for definition and measurement method.
- tREFI depends on T_{OPER}
- tIS(base) and tIH(base) values are for 1V/ns CMD/ADD single-ended slew rate and 2V/ns CK, \overline{CK} differential slew rate. Note for DQ and DM signals, $V_{REF}(DC) = V_{REF}DQ(DC)$. For input only pins except RESET, $V_{REF}(DC) = V_{REF}CA(DC)$. See "Address/Command Setup, Hold and Derating" on component datasheet.
- tDS(base) and tDH(base) values are for 1V/ns DQ single-ended slew rate and 2V/ns DQS, \overline{DQS} differential slew rate. Note for DQ and DM signals, $V_{REF}(DC) = V_{REF}DQ(DC)$. For input only pins except RESET, $V_{REF}(DC) = V_{REF}CA(DC)$. See "Data Setup, Hold and Slew Rate Derating" on component datasheet.
- Start of internal write transaction is defined as follows ;
For BL8 (fixed by MRS and on-the-fly) : Rising clock edge 4 clock cycles after WL.
For BC4 (on-the-fly) : Rising clock edge 4 clock cycles after WL
For BC4 (fixed by MRS) : Rising clock edge 2 clock cycles after WL
- The maximum read preamble is bound by tLZDQS(min) on the left side and tDQSCk(max) on the right side. See "Device Operation & Timing Diagram Datasheet"
- CKE is allowed to be registered low while operations such as row activation, precharge, autorecharge or refresh are in progress, but power-down IDD spec will not be applied until finishing those operations.
- Although CKE is allowed to be registered LOW after a REFRESH command once tREFPDEN(min) is satisfied, there are cases where additional time such as tXPDLL(min) is also required. See "Device Operation & Timing Diagram Datasheet".
- Defined between end of MPR read burst and MRS which reloads MPR or disables MPR function.
- One ZQCS command can effectively correct a minimum of 0.5 % (ZQCorrection) of RON and RTT impedance error within 64 nCK for all speed bins assuming the maximum sensitivities specified in the 'Output Driver Voltage and Temperature Sensitivity' and 'ODT Voltage and Temperature Sensitivity' tables. The appropriate interval between ZQCS commands can be determined from these tables and other application specific parameters. One method for calculating the interval between ZQCS commands, given the temperature (Tdriftrate) and voltage (Vdriftrate) drift rates that the SDRAM is subject to in the application, is illustrated. The interval could be defined by the following formula:

$$\frac{ZQCorrection}{(TSens \times Tdriftrate) + (VSens \times Vdriftrate)}$$

where TSens = max(dRRTTdT, dRONdTM) and VSens = max(dRRTTdV, dRONdVM) define the SDRAM temperature and voltage sensitivities.

For example, if TSens = 1.5% /°C, VSens = 0.15% / mV, Tdriftrate = 1°C / sec and Vdriftrate = 15 mV / sec, then the interval between ZQCS commands is calculated as:

$$\frac{0.5}{(1.5 \times 1) + (0.15 \times 15)} = 0.133 \approx 128\text{ms}$$

- n = from 13 cycles to 50 cycles. This row defines 38 parameters.
- tCH(abs) is the absolute instantaneous clock high pulse width, as measured from one rising edge to the following falling edge.
- tCL(abs) is the absolute instantaneous clock low pulse width, as measured from one falling edge to the following rising edge.
- The tIS(base) AC150 specifications are adjusted from the tIS(base) specification by adding an additional 100 ps of derating to accommodate for the lower alternate threshold of 150 mV and another 25 ps to account for the earlier reference point [(175 mv - 150 mV) / 1 V/ns].
- Pulse width of a input signal is defined as the width between the first crossing of $V_{REF}(DC)$ and the consecutive crossing of $V_{REF}(DC)$
- tDQSL describes the instantaneous differential input low pulse width on $DQS-\overline{DQS}$, as measured from one falling edge to the next consecutive rising edge.
- tDQSH describes the instantaneous differential input high pulse width on $DQS-\overline{DQS}$, as measured from one rising edge to the next consecutive falling edge.
- tDQSH, act + tDQSL, act = 1 tCK, act ; with tXYZ, act being the actual measured value of the respective timing parameter in the application.
- tDSH, act + tDSS, act = 1 tCK, act ; with tXYZ, act being the actual measured value of the respective timing parameter in the application.

20. Physical Dimensions

20.1 1Gbx4 based 1Gx72 Module (1 Rank) - M392B1G70BH0

Units : Millimeters

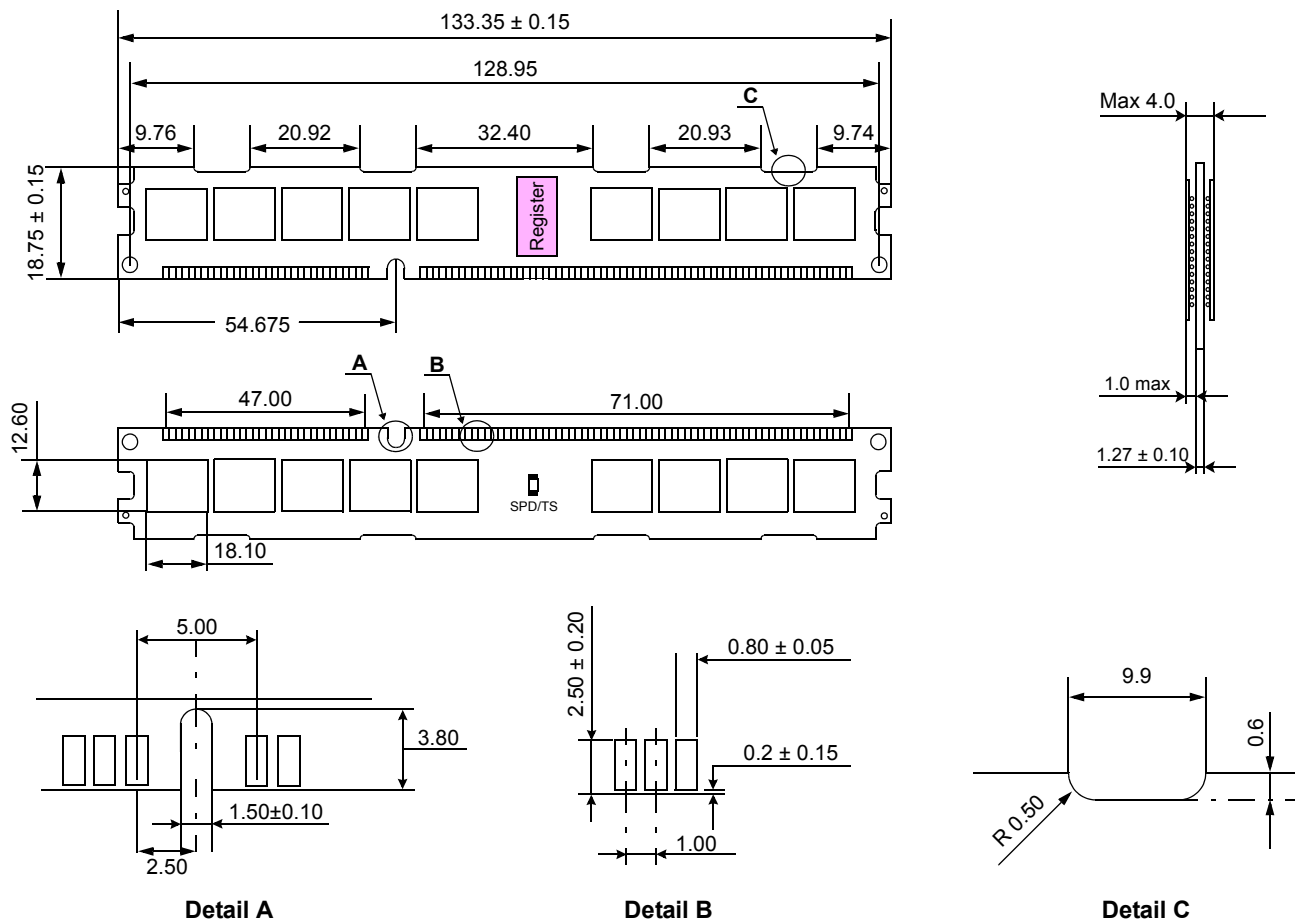

20.1.1 x72 DIMM, populated as one physical rank of x4 DDR3 SDRAMs

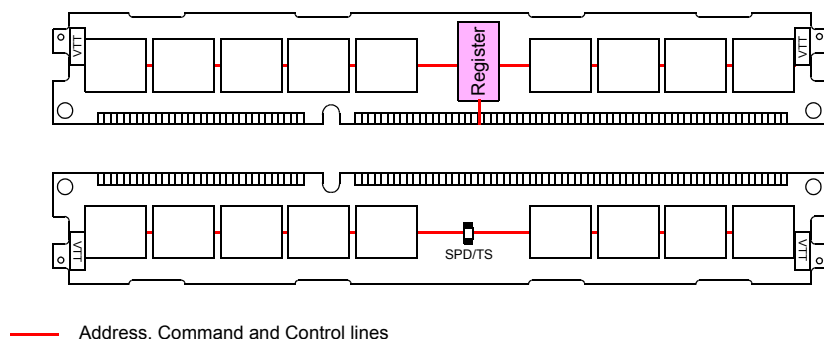

The used device is 1Gb x4 DDR3L SDRAM, FBGA.
 DDR3 SDRAM Part NO : K4B4G0446B-HY**

* **NOTE** : Tolerances on all dimensions ±0.15 unless otherwise specified.

20.2 512Mbx8 based 1Gx72 Module (2 Ranks) - M392B1G73BH0

Units : Millimeters

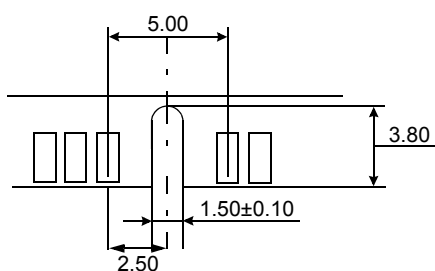
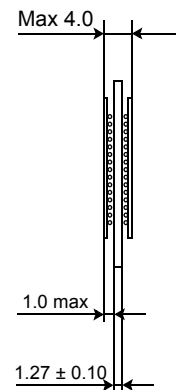
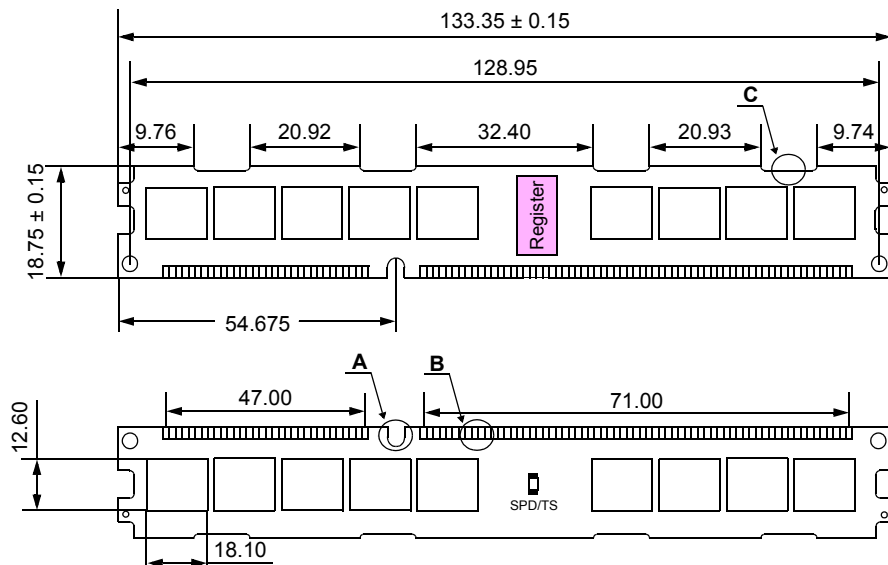

Detail A

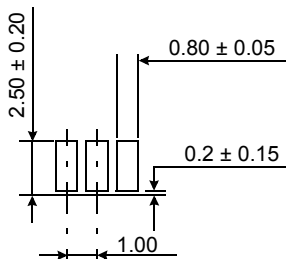

Detail B

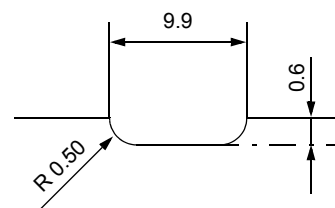

Detail C

20.2.1 x72 DIMM, populated as two physical ranks of x8 DDR3 SDRAMs

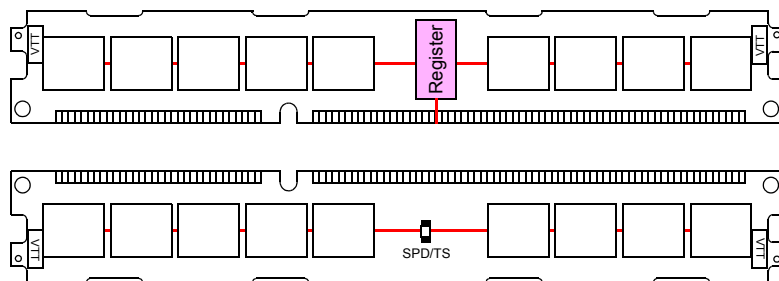

— Address, Command and Control lines

The used device is 512M x8 DDR3L SDRAM, FBGA.
 DDR3 SDRAM Part NO : K4B4G0846B-HY**

* NOTE : Tolerances on all dimensions ±0.15 unless otherwise specified.

20.3 2Gbx4(DDP) based 2Gx72 Module (2 Ranks) - M392B2G70BM0

Units : Millimeters

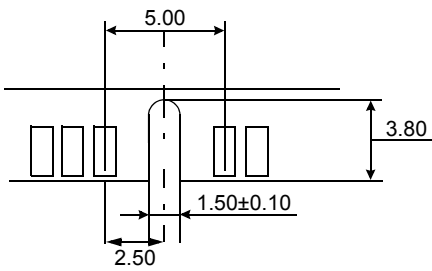
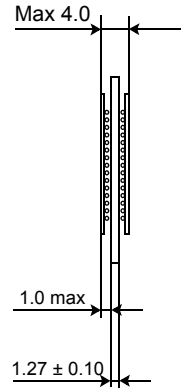
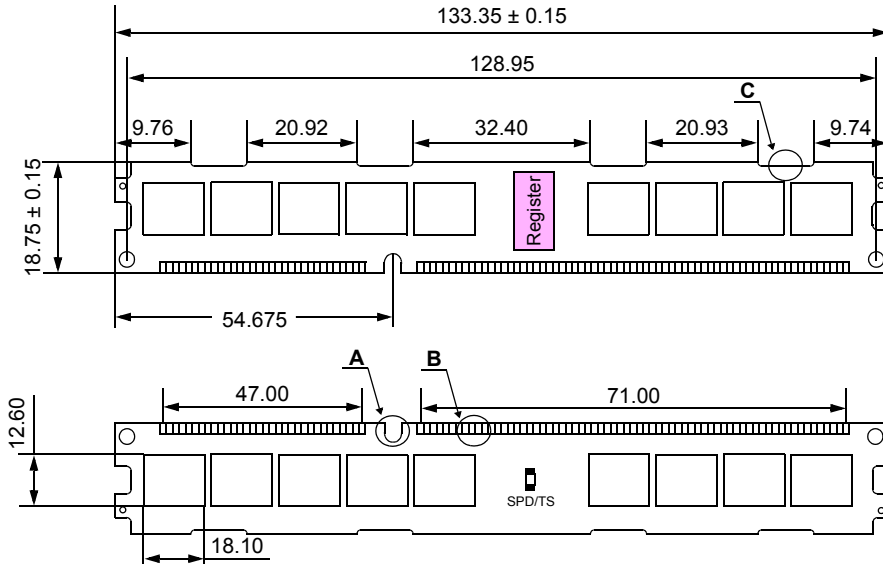

Detail A

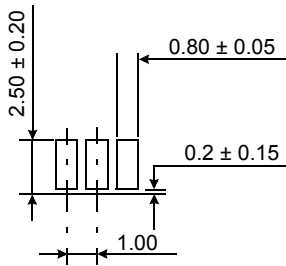

Detail B

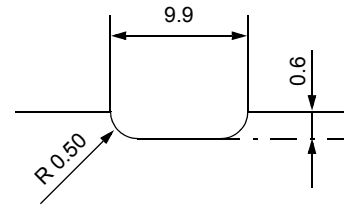

Detail C

20.3.1 x72 DIMM, populated as two physical ranks of x4 DDR3 SDRAMs

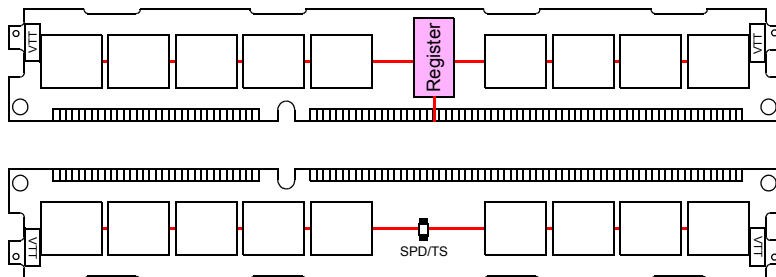

— Address, Command and Control lines

The used device is 2G x4(DDP) DDR3L SDRAM, FBGA.
 DDR3 SDRAM Part NO : K4B8G0446B-MY**

* NOTE : Tolerances on all dimensions ±0.15 unless otherwise specified.

20.4 1Gbx8(DDP) based 2Gx72 Module (4 Ranks) - M392B2G73BM0

Units : Millimeters

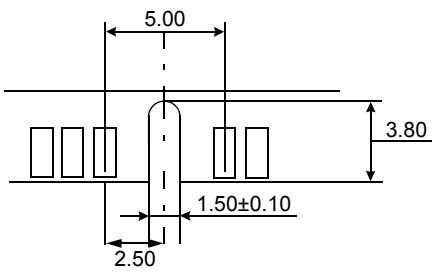
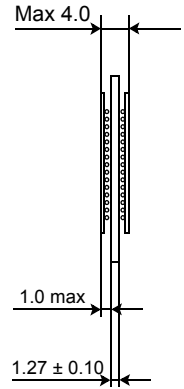
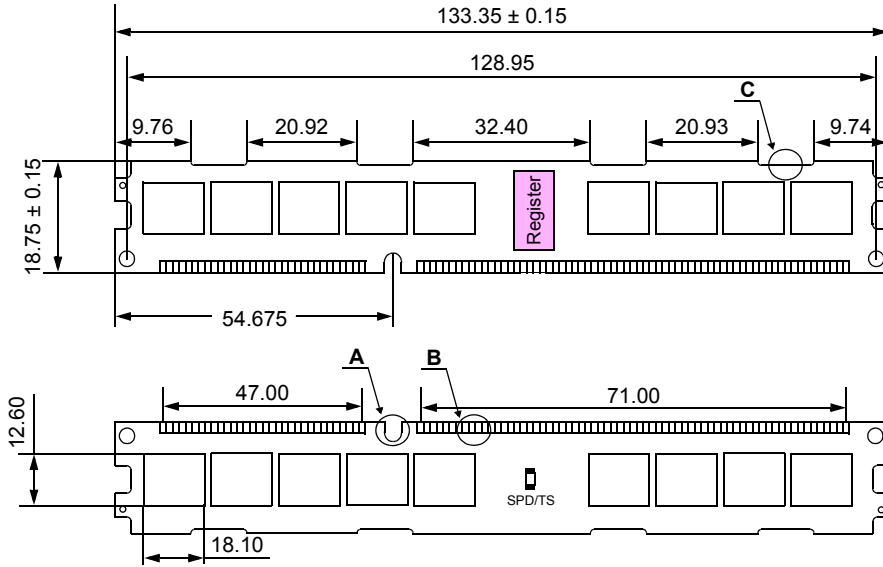

Detail A

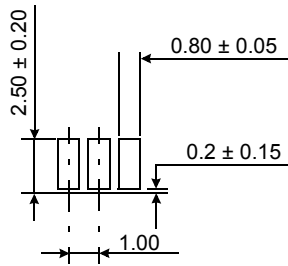

Detail B

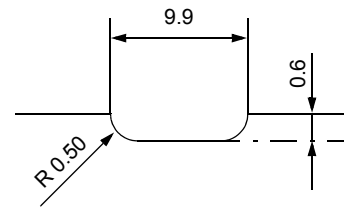

Detail C

20.4.1 x72 DIMM, populated as four physical ranks of x8 DDR3 SDRAMs

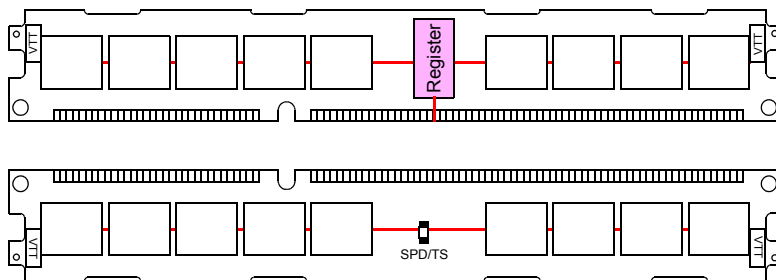

— Address, Command and Control lines

The used device is 1G x8(DDP) DDR3L SDRAM, FBGA.
DDR3 SDRAM Part NO : K4B8G0846B-MY**

* NOTE : Tolerances on all dimensions ±0.15 unless otherwise specified.

20.4.2 16GB Heat Spreader Design Guide

1. FRONT PART

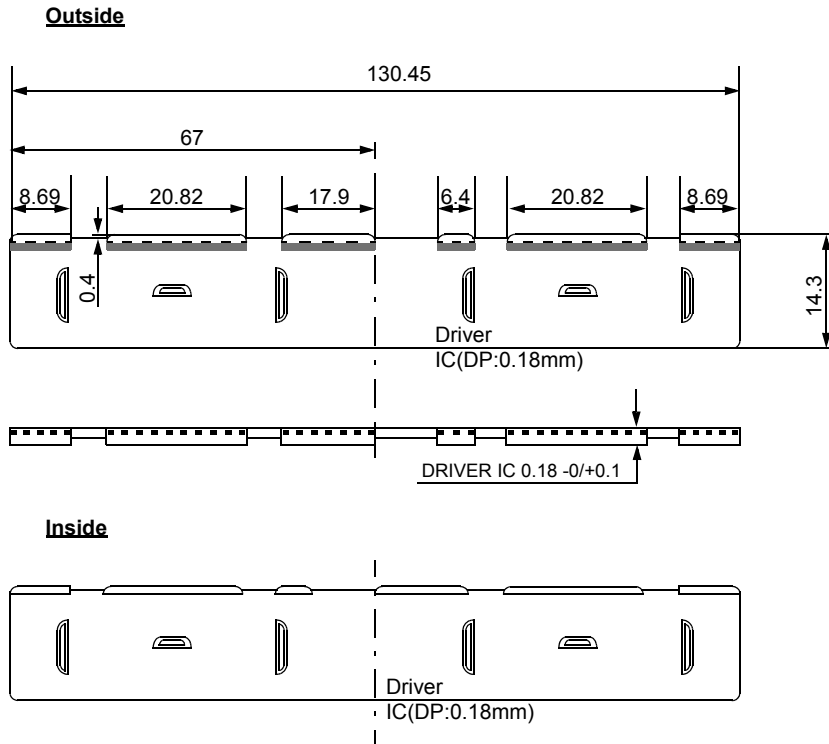

2. BACK PART

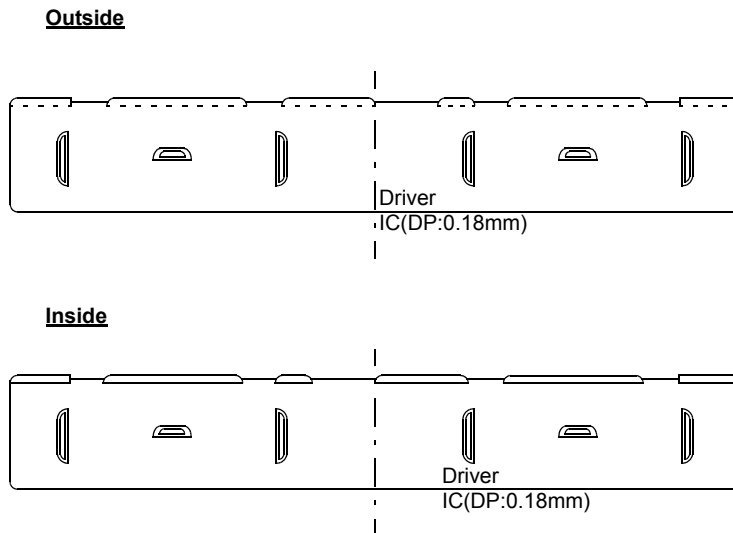

3. CLIP PART

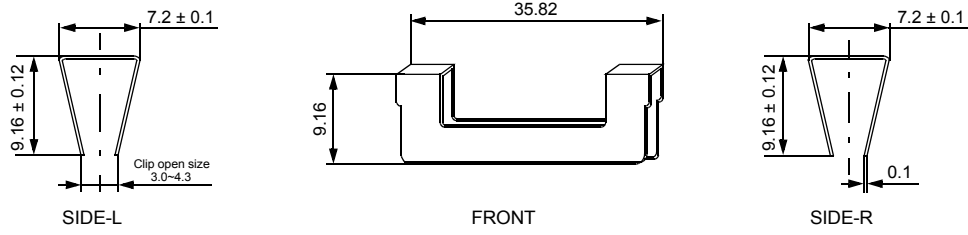

4. ASS'Y VIEW

Reference thickness total (Maximum) : 7.55 (With Clip thickness)

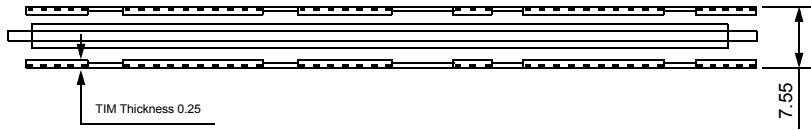

20.5 4Gbx4(QDP) based 4Gx72 Module (4 Ranks) - M392B4G70BE0

Units : Millimeters

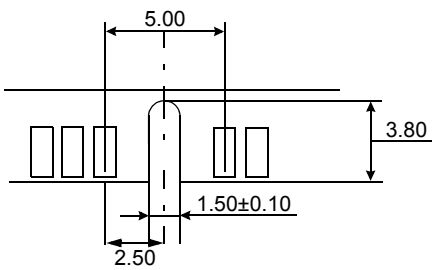
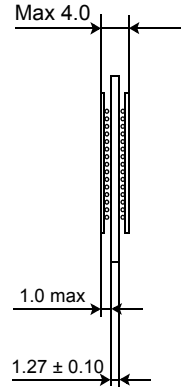
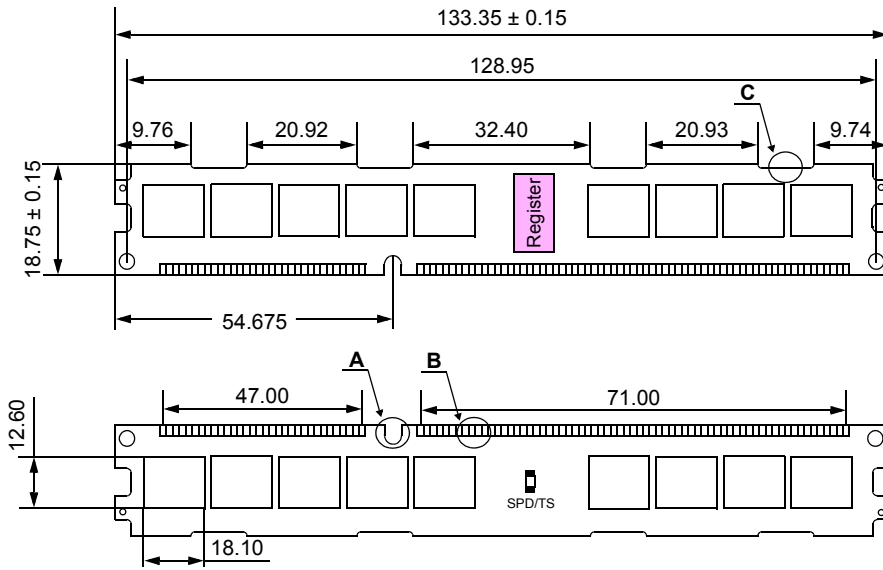

Detail A

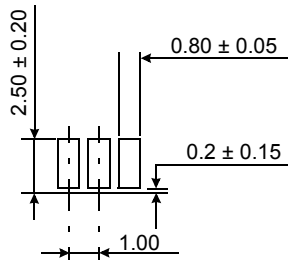

Detail B

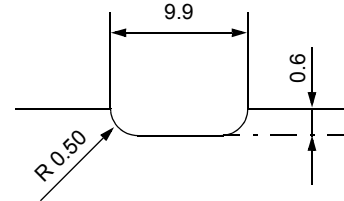

Detail C

20.5.1 x72 DIMM, populated as four physical ranks of x4 DDR3 SDRAMs

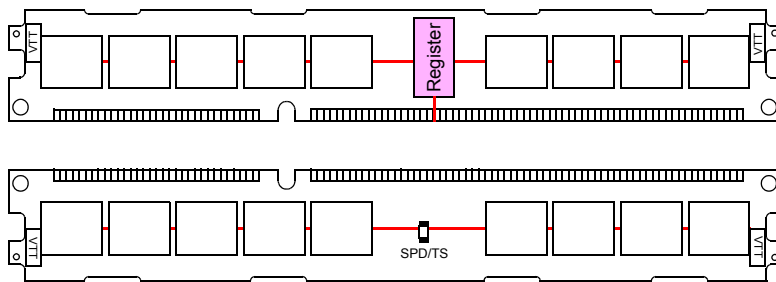

— Address, Command and Control lines

The used device is 4G x4(QDP) DDR3L SDRAM, FBGA.
DDR3 SDRAM Part NO : K4BAG0446B-EY**

* NOTE : Tolerances on all dimensions ±0.15 unless otherwise specified.

20.5.2 32GB Heat Spreader Design Guide

1. FRONT PART

Outside

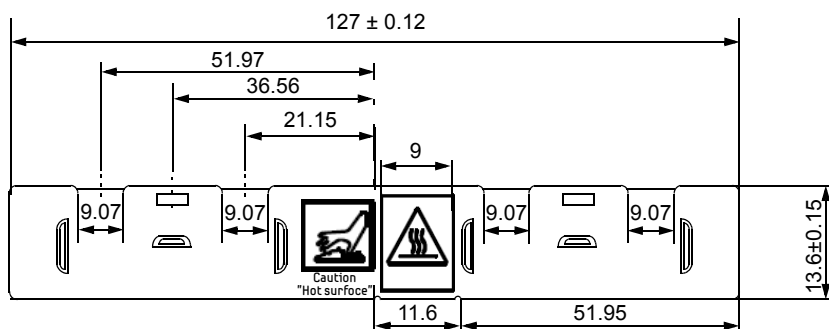

Inside

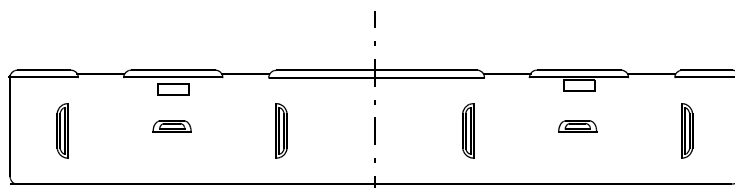

2. BACK PART

Outside

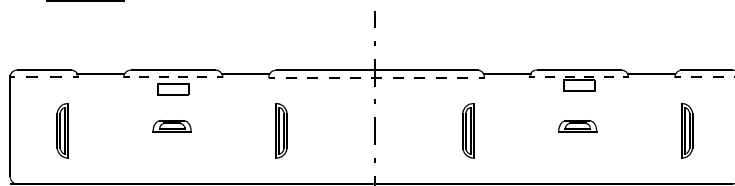

Inside

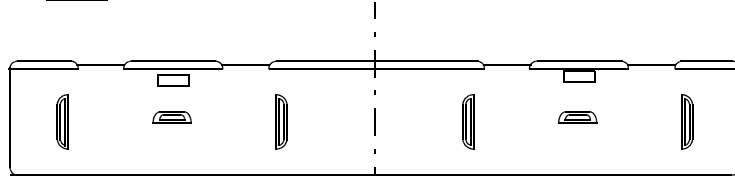

3. CLIP PART

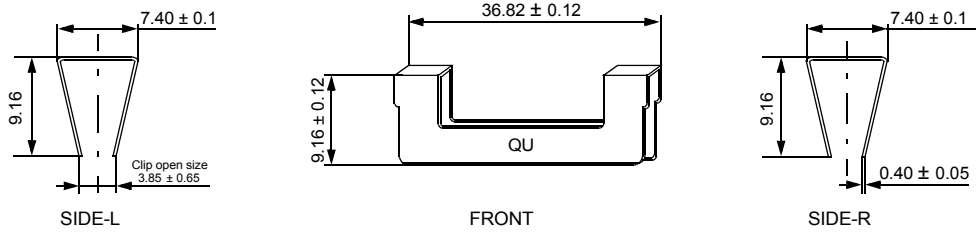

4. ASS'Y VIEW

Reference thickness total (Maximum) : 8 (With Clip thickness)

