



# U74ACT14

CMOS IC

## HEX SCHMITT-TRIGGER INVERTERS

### DESCRIPTION

The **U74ACT14** contains six inverters with Schmitt-trigger, provides the Function  $Y = \bar{A}$ .

The **U74ACT14** have hysteresis between the positive-going and negative-going and negative-going input thresholds.

### FEATURES

- \* Inputs are TTL-Voltage Compatible
- \* Outputs source/sink 24mA
- \* Pb-Free Packages are available

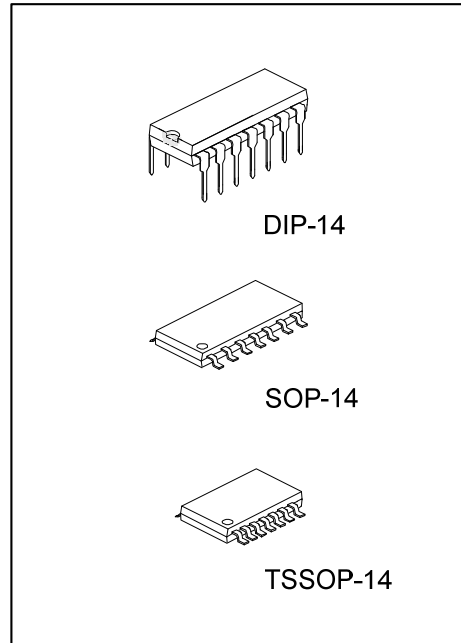

\*Pb-free plating product number:  
U74ACT14L

### ORDERING INFORMATION

Ordering Number		Package	Packing
Normal	Lead Free Plating		
U74ACT14-D14-T	U74ACT14L-D14-T	DIP-14	Tube
U74ACT14-S14-T	U74ACT14L-S14-T	SOP-14	Tube
U74ACT14-S14-R	U74ACT14L-S14-R	SOP-14	Tape Reel
U74ACT14-P14-T	U74ACT14L-P14-T	TSSOP-14	Tube

<p>U74ACT14L-D14-T</p> <p>(1)Packing Type (2)Package Type (3)Lead Plating</p>	<p>(1) R: Tape Reel, T: Tube (2) D14: DIP-14, S14: SOP-14, P14: TSSOP-14 (3) L: Lead Free Plating, Blank: Pb/Sn</p>
---	---

■ PIN CONFIGURATION

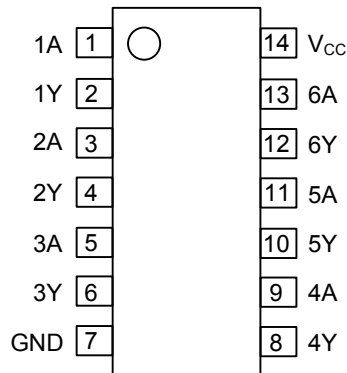

■ FUNCTIONAL DIAGRAM

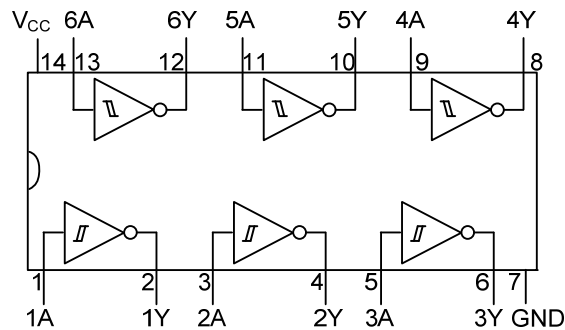

■ FUNCTION TABLE

INPUT	OUTPUT
A	Y
L	H
H	L

■ LOGIC DIAGRAM (positive logic)

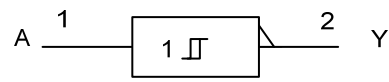
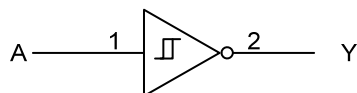

IEC logic symbol

## ■ ABSOLUTE MAXIMUM RATINGS (unless otherwise specified)

PARAMETER	SYMBOL	RATINGS	UNIT
Supply Voltage	$V_{CC}$	-0.5~7	V
Input Voltage	$V_{IN}$	-0.5~ $V_{CC}+0.5$	V
Output Voltage	$V_{OUT}$	-0.5~ $V_{CC}+0.5$	V
Input Clamp Current	$I_{IK}$	±20	mA
Output Clamp Current	$I_{OK}$	±20	mA
Output Current	$I_{OUT}$	±50	mA
$V_{CC}$ or GND Current	$I_{CC}$	±50	mA
Storage Temperature	$T_{STG}$	-65 ~ +150	°C

Note: Absolute maximum ratings are those values beyond which the device could be permanently damaged.

Absolute maximum ratings are stress ratings only and functional device operation is not implied.

## ■ RECOMMENDED OPERATING CONDITIONS

PARAMETER	SYMBOL	MIN	TYP	MAX	UNIT
Supply Voltage	$V_{CC}$	4.5		5.5	V
Input Voltage	$V_{IN}$	0		$V_{CC}$	V
Output Voltage	$V_{OUT}$	0		$V_{CC}$	V
Operating Temperature	$T_A$	-40		+85	°C

## ■ ELECTRICAL CHARACTERISTICS ( $T_a=25^{\circ}C$ )

PARAMETER	SYMBOL	TEST CONDITIONS	MIN	TYP	MAX	UNIT
High-Level Input Voltage	$V_{IH}$	$V_{CC}=4.5V$	2.0			V
		$V_{CC}=5.5V$	2.0			V
Low-Level Input Voltage	$V_{IL}$	$V_{CC}=4.5V$			0.8	V
		$V_{CC}=5.5V$			0.8	V
Hysteresis	$V_{TH}$	$V_{CC}=4.5V$	0.4		1.4	V
		$V_{CC}=5.5V$	0.5		1.6	V
High-Level Output Voltage	$V_{OH}$	$V_{CC}=4.5V, I_{OH}=-50\mu A$	4.34	4.49		V
		$V_{CC}=5.5V, I_{OH}=-50\mu A$	5.4	5.49		V
		$V_{CC}=4.5V, I_{OH}=-24mA$	3.86			V
		$V_{CC}=5.5V, I_{OH}=-24mA$	4.86			V
Low-Level Output Voltage	$V_{OL}$	$V_{CC}=4.5V, I_{OL}=50\mu A$		0.001	0.1	V
		$V_{CC}=5.5V, I_{OL}=50\mu A$		0.001	0.1	V
		$V_{CC}=4.5V, I_{OL}=24mA$			0.36	V
		$V_{CC}=5.5V, I_{OL}=24mA$			0.36	V
Input Leakage Current	$I_{I(LEAK)}$	$V_{CC}=5.5V, V_{IN}=5.5V$ or GND			±0.1	μA
Maximum $I_{CC}$ /Input	$I_{CCT}$	$V_{CC}=5.5V, V_{IN}=V_{CC}-2.1V$		0.6		mA
Quiescent Supply Current	$I_Q$	$V_{CC}=5.5V, V_{IN}=V_{CC}$ or GND, $I_{OUT}=0$			2.0	μA
Input Capacitance	$C_{IN}$	$V_{CC}=OPEN$		4.5		pF

Note: Not more than one output should be tested at a time, and the duration of the test should not exceed 2 ms.

## ■ SWITCHING CHARACTERISTICS ( $T_a=25^{\circ}C$ )

PARAMETER	SYMBOL	TEST CONDITIONS	MIN	TYP	MAX	UNIT
Propagation delay from input (A) to output(Y)	$t_{PLH}$	$V_{CC}=5.0V\pm 0.5V, C_L=50pF$	3.0	8.0	10.0	ns
	$t_{PHL}$	$V_{CC}=5.0V\pm 0.5V, C_L=50pF$	3.0	8.0	10.0	ns

## ■ OPERATING CHARACTERISTIC

PARAMETER	SYMBOL	TEST CONDITIONS	MIN	TYP	MAX	UNIT
Power Dissipation Capacitance	$C_{pd}$	$V_{CC}=5$		80		pF

## ■ TEST CIRCUIT AND WAVEFORMS

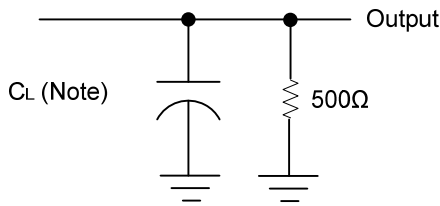

Note:  $C_L$  includes probe and jig capacitance.

Fig-1 Load circuitry for switching times.

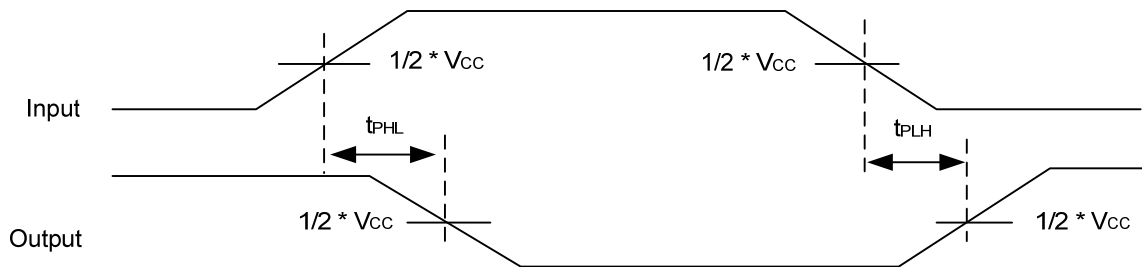

Fig-2 Propagation delay from input(A) to output(Y).

UTC assumes no responsibility for equipment failures that result from using products at values that exceed, even momentarily, rated values (such as maximum ratings, operating condition ranges, or other parameters) listed in products specifications of any and all UTC products described or contained herein. UTC products are not designed for use in life support appliances, devices or systems where malfunction of these products can be reasonably expected to result in personal injury. Reproduction in whole or in part is prohibited without the prior written consent of the copyright owner. The information presented in this document does not form part of any quotation or contract, is believed to be accurate and reliable and may be changed without notice.