



# UT3401Z

Power MOSFET

## P-CHANNEL ENHANCEMENT MODE

### DESCRIPTION

The UTC **UT3401Z** is P-channel enhancement mode Power MOSFET, designed with high density cell, with fast switching speed, low on-resistance, excellent thermal and electrical capabilities and operation with low gate voltages.

This device is suitable for use as a load switch or in PWM applications.

### SYMBOL

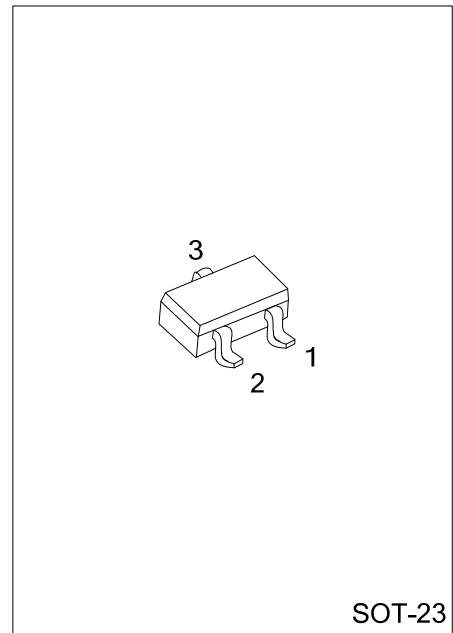
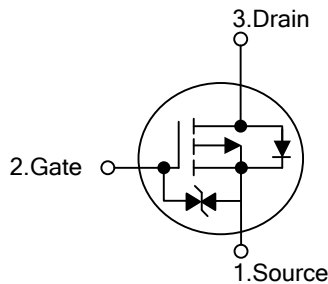

SOT-23

### ORDERING INFORMATION

Ordering Number		Package	Pin Assignment			Packing
Lead Free	Halogen Free		1	2	3	
UT3401ZL-AE3-R	UT3401ZG-AE3-R	SOT-23	S	G	D	Tape Reel

<p>UT3401ZL-AE3-R</p> <p>(1) Packing Type (2) Package Type (3) Lead Plating</p>	<p>(1) R: Tape Reel (2) AE3: SOT-23 (3) G: Halogen Free, L: Lead Free</p>
---	---

### MARKING

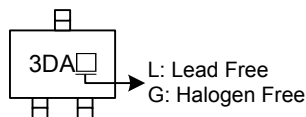

### ■ ABSOLUTE MAXIMUM RATINGS (Ta = 25°C, unless otherwise specified)

PARAMETER	SYMBOL	RATINGS	UNITS	
Drain-Source Voltage	V <sub>DSS</sub>	-30	V	
Gate-Source Voltage	V <sub>GSS</sub>	±12	V	
Drain Current	Continuous (Note2)	I <sub>D</sub>	-4.2	A
	Pulsed (Note3)	I <sub>DM</sub>	-30	A
Power Dissipation (Note 2)	P <sub>D</sub>	1.4	W	
ESD(HBM)		±100	V	
Junction Temperature	T <sub>J</sub>	+150	°C	
Storage Temperature	T <sub>STG</sub>	-55 ~ +150	°C	

Notes: 1. Absolute maximum ratings are those values beyond which the device could be permanently damaged.

Absolute maximum ratings are stress ratings only and functional device operation is not implied.

2. Pulse width limited by T<sub>J(MAX)</sub>

3. Pulse width ≤300μs, duty cycle ≤2%

### ■ THERMAL DATA

PARAMETER	SYMBOL	MIN	TYP	MAX	UNIT
Junction to Ambient	θ <sub>JA</sub>		65	90	°C/W

### ■ ELECTRICAL CHARACTERISTICS (Ta=25°C, unless otherwise specified)

PARAMETER	SYMBOL	TEST CONDITIONS	MIN	TYP	MAX	UNIT
<b>OFF CHARACTERISTICS</b>						
Drain-Source Breakdown Voltage	BV <sub>DSS</sub>	I <sub>D</sub> =-250μA, V <sub>GS</sub> =0V	-30			V
Drain-Source Leakage Current	I <sub>DSS</sub>	V <sub>DS</sub> =-24V, V <sub>GS</sub> =0V			-1	μA
Gate-Source Leakage Current	I <sub>GSS</sub>	V <sub>DS</sub> =0V, V <sub>GS</sub> =±12V			±5	μA
<b>ON CHARACTERISTICS</b>						
Gate Threshold Voltage	V <sub>GS(TH)</sub>	V <sub>DS</sub> =V <sub>GS</sub> , I <sub>D</sub> =-250μA	-0.7	-1	-1.3	V
Drain-Source On-State Resistance (Note 2)	R <sub>DS(ON)</sub>	V <sub>GS</sub> =-10V, I <sub>D</sub> =-4.2A		42	50	mΩ
		V <sub>GS</sub> =-4.5V, I <sub>D</sub> =-4A		53	65	mΩ
		V <sub>GS</sub> =-2.5V, I <sub>D</sub> =-1A		80	120	mΩ
<b>DYNAMIC PARAMETERS</b>						
Input Capacitance	C <sub>ISS</sub>	V <sub>GS</sub> =0V, V <sub>DS</sub> =-15V, f=1MHz		954		pF
Output Capacitance	C <sub>OSS</sub>			115		pF
Reverse Transfer Capacitance	C <sub>RSS</sub>			77		pF
<b>SWITCHING PARAMETERS</b>						
Turn-ON Delay Time (Note 2)	t <sub>D(ON)</sub>	V <sub>GS</sub> =-10V, V <sub>DS</sub> =-15V R <sub>L</sub> =3.6Ω, R <sub>G</sub> =6Ω		6.3		ns
Turn-ON Rise Time	t <sub>R</sub>			3.2		ns
Turn-OFF Delay Time	t <sub>D(OFF)</sub>			38.2		ns
Turn-OFF Fall Time	t <sub>F</sub>			12		ns
Total Gate Charge (Note 2)	Q <sub>G</sub>	V <sub>GS</sub> =-4.5V, V <sub>DS</sub> =-15V, I <sub>D</sub> =-4A		9.4		nC
Gate-Source Charge	Q <sub>GS</sub>			2		nC
Gate-Drain Charge	Q <sub>GD</sub>			3		nC
<b>SOURCE- DRAIN DIODE RATINGS AND CHARACTERISTICS</b>						
Drain-Source Diode Forward Voltage(Note2)	V <sub>SD</sub>	V <sub>DS</sub> =0V, I <sub>S</sub> =-1A		-0.75	-1	V
Maximum Continuous Drain-Source Diode Forward Current	I <sub>S</sub>				-2.2	A
Reverse Recovery Time	t <sub>RR</sub>	I <sub>F</sub> =-4A, dI/dt=100A/μs		20.2		ns
Reverse Recovery Charge	Q <sub>RR</sub>				11.2	

Notes: 1. Pulse width limited by T<sub>J(MAX)</sub>

2. Pulse width ≤300μs, duty cycle ≤2%

3. Surface mounted on 1 in<sup>2</sup> copper pad of FR4 board

## TYPICAL CHARACTERISTICS

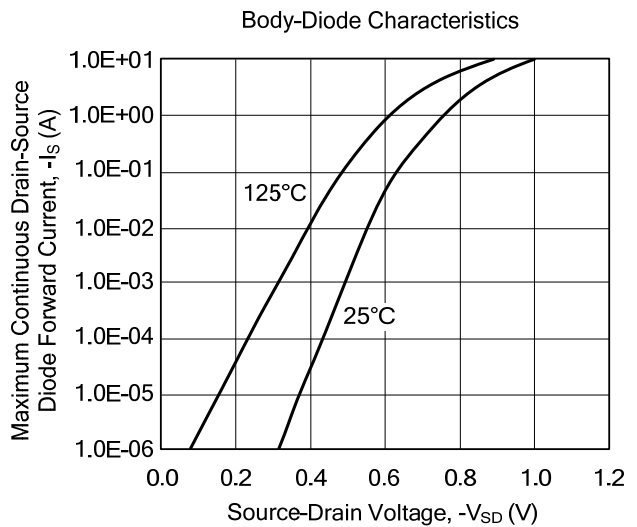
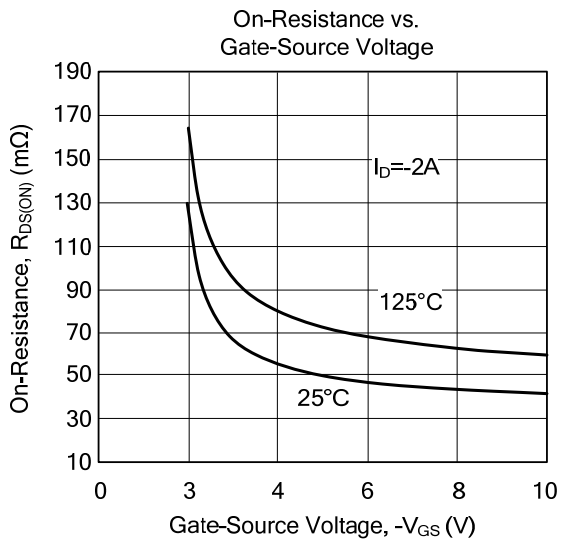
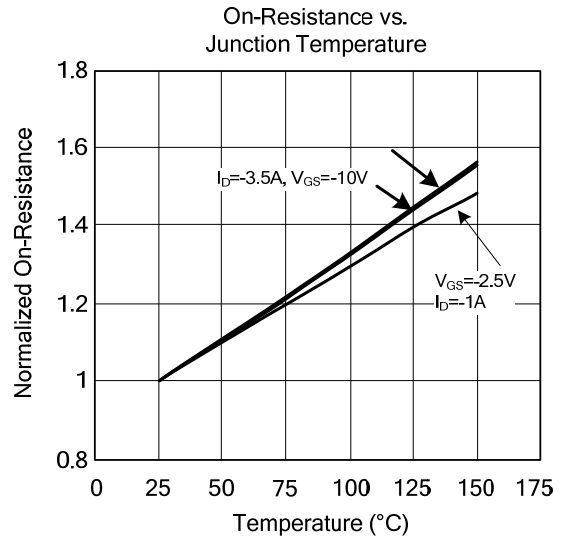
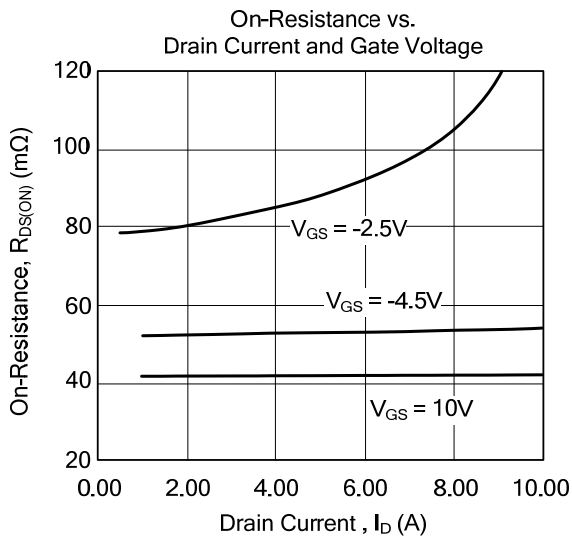
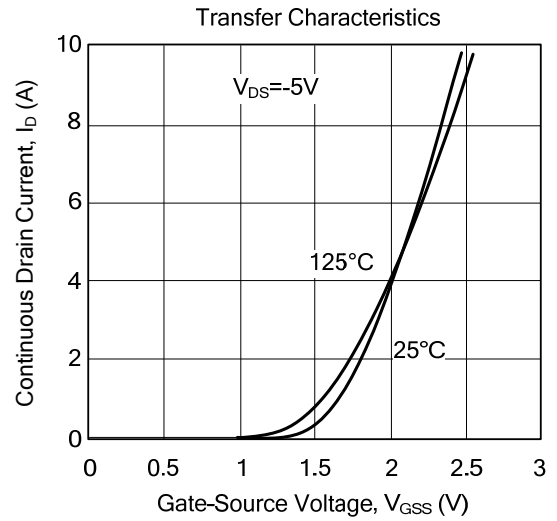
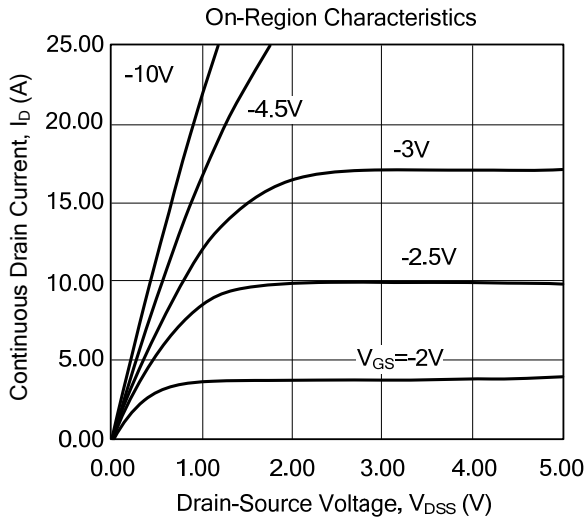

## TYPICAL CHARACTERISTICS(Cont.)

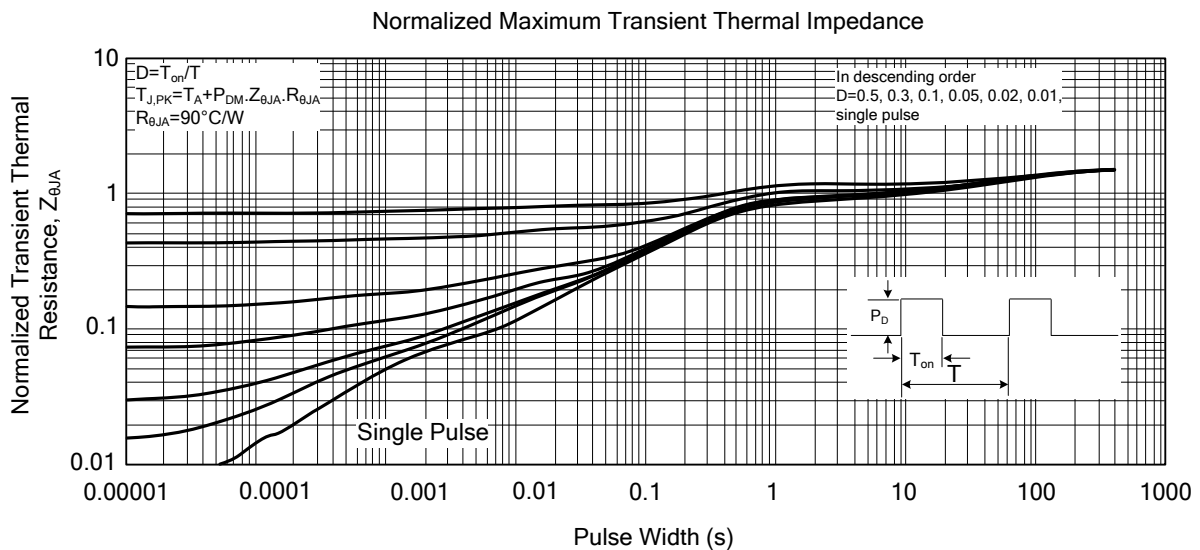
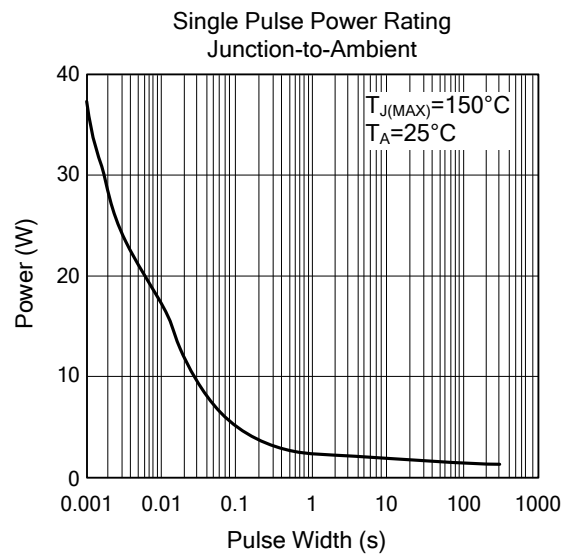
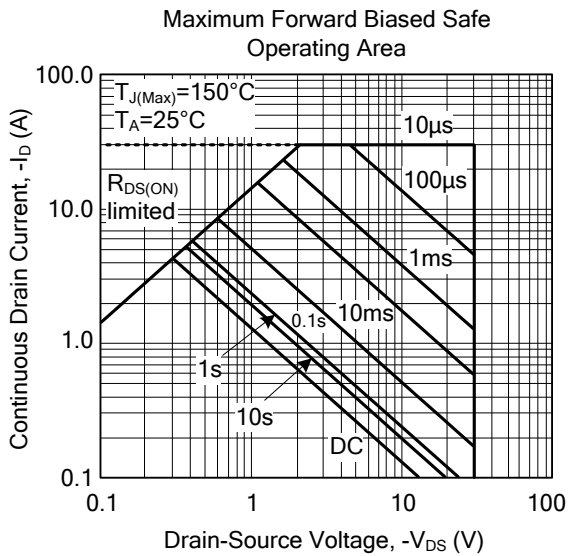
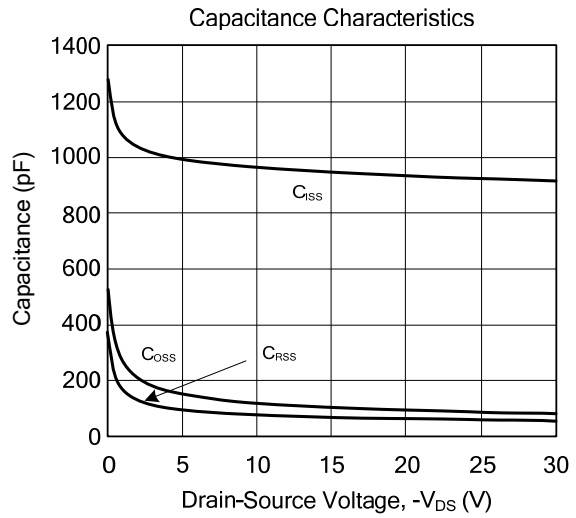
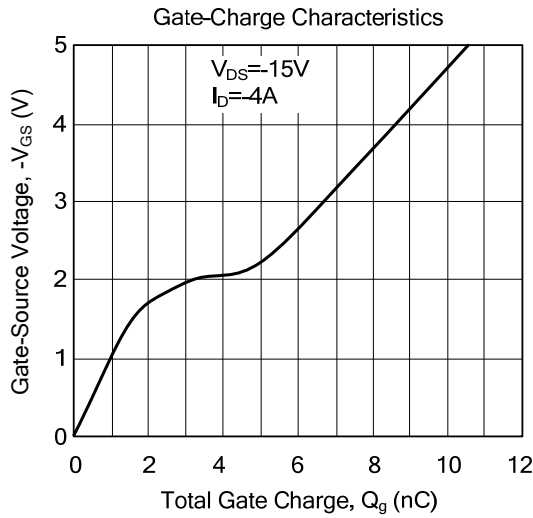

UTC assumes no responsibility for equipment failures that result from using products at values that exceed, even momentarily, rated values (such as maximum ratings, operating condition ranges, or other parameters) listed in products specifications of any and all UTC products described or contained herein. UTC products are not designed for use in life support appliances, devices or systems where malfunction of these products can be reasonably expected to result in personal injury. Reproduction in whole or in part is prohibited without the prior written consent of the copyright owner. The information presented in this document does not form part of any quotation or contract, is believed to be accurate and reliable and may be changed without notice.