

TRIACS

DESCRIPTION

Passivated triacs in a full pack plastic envelope, intended for use in applications requiring high bidirectional transient and blocking voltage capability and high thermal cycling performance. Typical applications include motor control, industrial and domestic lighting, heating and static switching.

SYMBOL

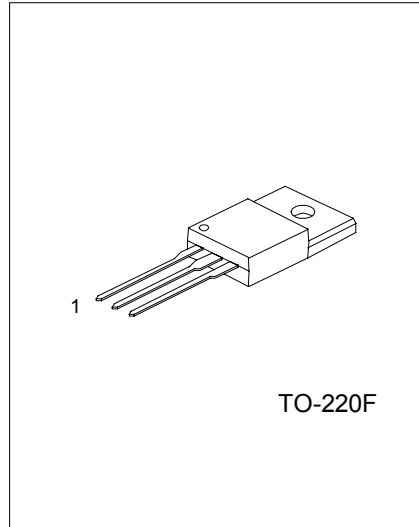
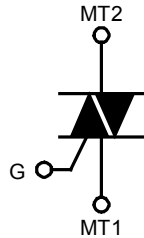

1:MT1 2:MT2 3:GATE

ABSOLUTE MAXIMUM RATINGS

PARAMETER	SYMBOL	RATINGS	UNIT
Repetitive Peak Off State Voltage UT137FF/FG-5 UT137FF/FG-6 UT137FF/FG-8	V _{DRM}	500* 600* 800	V
RMS On-state Current (Full sine wave, T _{hs} ≤ 73°C)	I _{T(RMS)}	8	A
Non-Repetitive Peak. On-State Current (Full sine wave, T _j = 125°C prior to surge, with reapplied V _{DRM(max)}) t = 20ms t = 16.7ms	I _{TSM}	55 60	A
I ² t For Fusing (t = 10ms)	I ² t	21	A ² s
Repetitive Rate of Rise of On-state Current after Triggering I _{TM} = 12A, I _G = 0.2A, dI _G /dt = 0.2A/μs T2+ G+ T2+ G- T2- G- T2- G+	dI _T /dt	50 50 50 10	A/μs
Peak Gate Voltage	V _{GM}	5	V
Peak Gate Current	I _{GM}	2	A
Peak Gate Power	P _{GM}	5	W
Average Gate Power (Over any 20ms period)	P _{G(AV)}	0.5	W
Operating Junction Temperature	T _j	125	°C
Storage Temperature	T _{stg}	-40~150	°C

*Although not recommended, off-state voltages up to 800V may be applied without damage, but the triac may switch to the on-state. The rate of rise of current should not exceed 6A/μs.

ISOLATION LIMITING VALUE & CHARACTERISTIC (T_{HS}=25°C, unless otherwise specified)

PARAMETER	SYMBOL	MIN	TYP	MAX	UNIT
Repetitive peak voltage from all three terminals to external heatsink (R.H. ≤ 65%, clean and dustfree)	V _{isol}			1500	V
Capacitance from MT2 to external heatsink (f=1MHz)	C _{isol}		12		pF

THERMAL RESISTANCES

PARAMETER	SYMBOL	MIN	TYP	MAX	UNIT
Thermal Resistance Junction to heatsink (full or half cycle) with heatsink compound without heatsink compound	R _{th j-hs}			4.5 6.5	K/W
Thermal Resistance Junction to Ambient (In free air)	R _{th j-a}		55		K/W

STATIC CHARACTERISTICS (T_J=25°C, unless otherwise specified)

PARAMETER	SYMBOL	CONDITIONS	MIN	TYP	MAX		UNIT
					UT137FF	UT137FG	
Gate trigger current	I _{GT}	V _D =12V, I _T =0.1A T2+ G+ T2+ G- T2- G- T2- G+		5	25	50	mA
				8	25	50	
				11	25	50	
				30	70	100	
Latching current	I _L	V _D =12V, I _{GT} =0.1A T2+ G+ T2+ G- T2- G- T2- G+		7	30	45	mA
				16	45	60	
				5	30	45	
				7	45	60	
Holding current	I _H	V _D = 12 V, I _{GT} = 0.1 A		5	20	40	mA
On-state voltage	V _T	I _T =10A		1.3	1.65		V
Gate trigger voltage	V _{GT}	V _D =12V, I _T =0.1A		0.7	1.5		V
		V _D =400V, I _T =0.1A, T _J =125°C	0.25	0.4			V
Off-state leakage current	I _D	V _D =V _{DRM(max)} , T _J =125°C		0.1	0.5		mA

DYNAMIC CHARACTERISTICS (T_J=25°C, unless otherwise specified)

PARAMETER	SYMBOL	CONDITIONS	MIN		TYP	MAX	UNIT
			UT137FF	UT137FG			
Critical rate of rise of Off-state voltage	dV _D /dt	V _{DM} = 67% V _{DRM(max)} ; T _J =125°C; exponential waveform; gate open circuit	50	200	250		V/μs
Critical rate of change of Commutating voltage	dV _{com} /dt	V _{DM} =400V; T _J =95°C; I _{T(RMS)} =8A; dI _{com} /dt =3.6A/ms; gate open circuit		10	20		V/μs
Gate controlled turn-on time	t _{gt}	I _{TM} = 12 A; V _D = V _{DRM(max)} ; I _G =0.1A; dI _G /dt=5A/μs			2		μs

TYPICAL CHARACTERISTICS

Figure 1. Maximum on-state Dissipation, P_{tot} vs RMS On-state Current, $I_T(RMS)$, Where α = Conduction Angle.

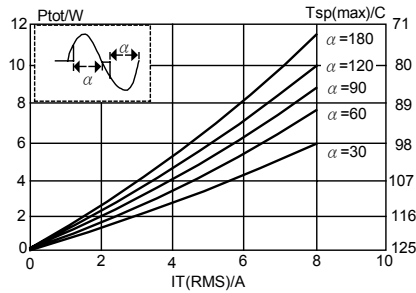

Figure 2. Maximum Permissible Non-repetitive Peak On-state Current I_{TSM} , vs Pulse Width t_p , for Sinusoidal Currents, $t_p \leq 20ms$

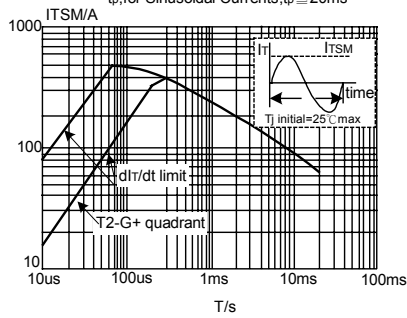

Figure 3. Maximum Permissible Non-Repetitive peak on-state Current I_{TSM} , vs Number of Cycles, for Sinusoidal Currents, $f=50Hz$

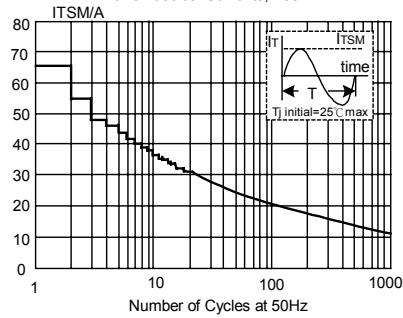

Figure 4. Maximum Permissible RMS Current $I_T(RMS)$ vs Heatsink Temperature T_{hs}

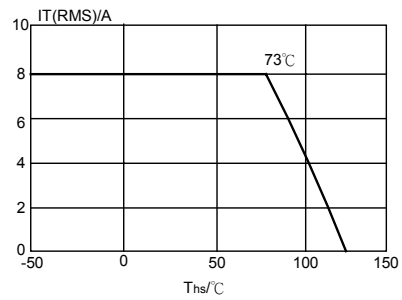

Figure 5. Maximum Permissible Repetitive RMS on-state Current $I_T(RMS)$, vs Surge Duration, for Sinusoidal Currents, $f=50Hz$, $T_{hs} \leq 73^\circ C$

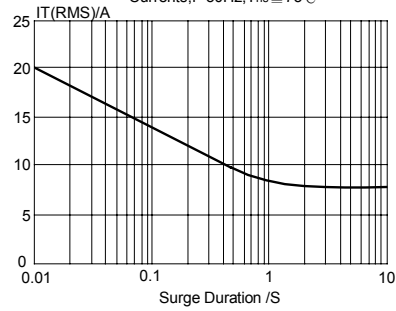

Figure 6. Normalised Gate Trigger Voltage $V_{GT}(T_j) / V_{GT}(25^\circ C)$, vs Junction Temperature T_j

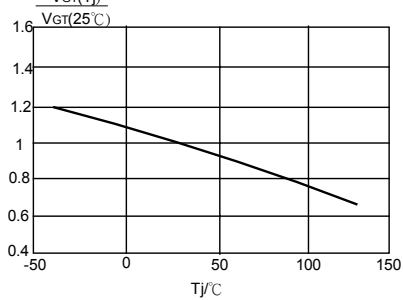

Figure 7. Normalised Gate Trigger Current $I_{GT}(T_j)/I_{GT}(25^\circ\text{C})$, vs Junction Temperature T_j

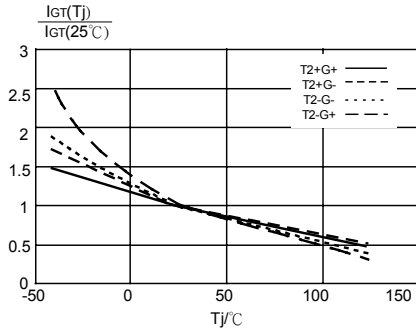

Figure 8. Normalised Latching Current $I_L(T_j)/I_L(25^\circ\text{C})$, vs Junction Temperature T_j

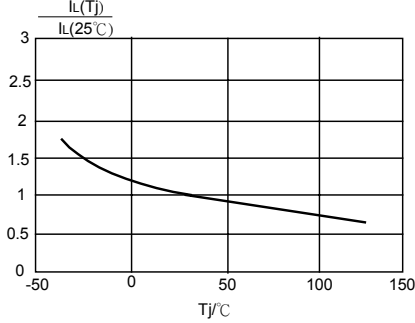

Figure 9. Normalised Holding Current $I_H(T_j)/I_H(25^\circ\text{C})$, vs Junction Temperature T_j

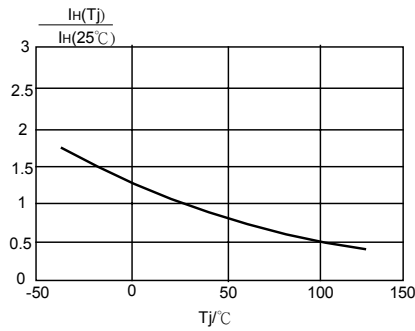

Figure 10. Typical and Maximum On-state Characteristic

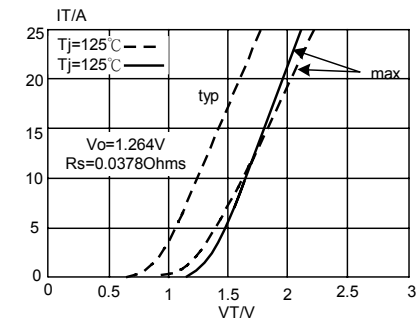

Figure 11. Transient Thermal Impedance $Z_{th\ j-hs}$, vs Pulse Width t_p

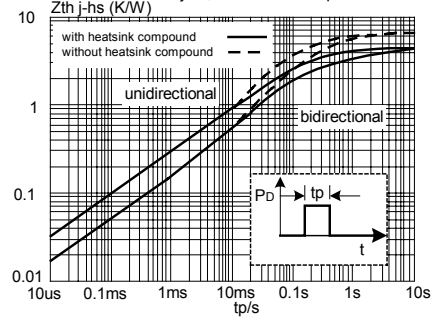
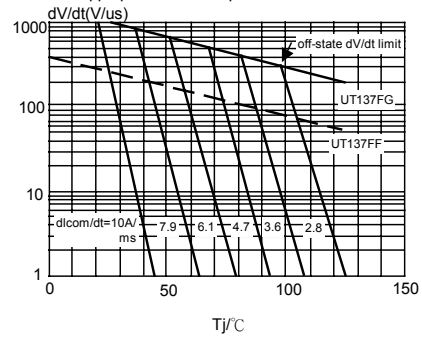

Figure 12. Typical commutation dV/dt vs junction temperature, parameter commutation dI/dt . The triac should commute when the dV/dt is below the value on the appropriate curve for pre-commutation dI/dt



UTC assumes no responsibility for equipment failures that result from using products at values that exceed, even momentarily, rated values (such as maximum ratings, operating condition ranges, or other parameters) listed in products specifications of any and all UTC products described or contained herein. UTC products are not designed for use in life support appliances, devices or systems where malfunction of these products can be reasonably expected to result in personal injury. Reproduction in whole or in part is prohibited without the prior written consent of the copyright owner. The information presented in this document does not form part of any quotation or contract, is believed to be accurate and reliable and may be changed without notice.