



# U74AHC1G32

CMOS IC

## SINGLE 2-INPUT POSITIVE-OR GATE

### DESCRIPTION

The UTC **U74AHC1G32** is a single 2-input positive-or gate, which provides the function  $Y=A+B$  in positive logic.

### FEATURES

- \* Operate from 2V to 5.5V
- \* Max  $t_{PD}$  of 6.5ns at 5 V
- \* Low Power Current:  $I_{CC}=10\mu A(\text{Max}) @ T_A=25^\circ C$

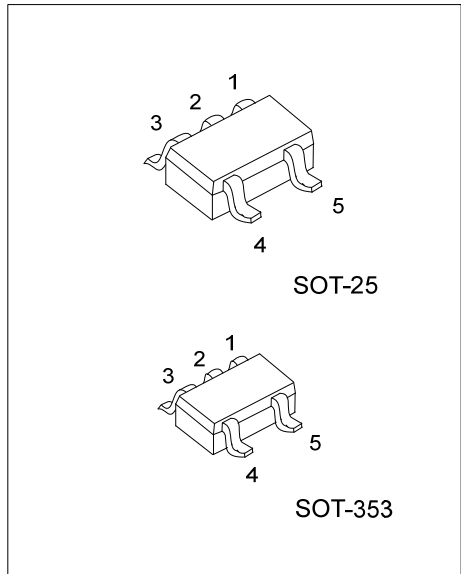

### ORDERING INFORMATION

Ordering Number		Package	Packing
Lead Free	Halogen Free		
U74AHC1G32L-AF5-R	U74AHC1G32G-AF5-R	SOT-25	Tape Reel
U74AHC1G32L-AL5-R	U74AHC1G32G-AL5-R	SOT-353	Tape Reel

<p>U74AHC1G32L-AL5-R</p> <p>(1) Packing Type (2) Package Type (3) Lead Free</p>	<p>(1) R: Tape Reel (2) AF5: SOT-25, AL5: SOT-353 (3) G: Halogen Free, L: Lead Free</p>
---	---

### MARKING

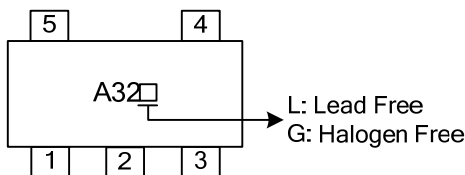

## ■ PIN CONFIGURATION

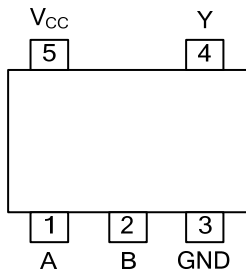

## ■ FUNCTION TABLE

INPUT(A)	INPUT(B)	OUTPUT(Y)
H	X	H
X	H	H
L	L	L

Note: H: high voltage level; L: low voltage level.

## ■ LOGIC DIAGRAM

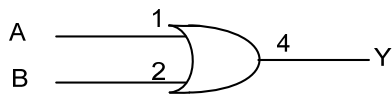

## ■ ABSOLUTE MAXIMUM RATING

PARAMETER	SYMBOL	RATINGS	UNIT
Supply Voltage	$V_{CC}$	-0.5 ~ 7	V
Input Voltage	$V_{IN}$	-0.5 ~ 7	V
Output Voltage	$V_{OUT}$	-0.5 ~ $V_{CC} + 0.5$	V
$V_{CC}$ or GND Current	$I_{CC}$	±50	mA
Output Current	$I_{OUT}$	±25	mA
Input Clamp Current	$I_{IK}$	-20	mA
Output Clamp Current	$I_{OK}$	±20	mA
Operating Temperature	$T_{OPR}$	-40 ~ +85	°C
Storage Temperature	$T_{STG}$	-65 ~ +150	°C

Note: Absolute maximum ratings are those values beyond which the device could be permanently damaged.

Absolute maximum ratings are stress ratings only and functional device operation is not implied.

## ■ RECOMMENDED OPERATING CONDITIONS

PARAMETER	SYMBOL	TEST CONDITIONS	MIN	TYP	MAX	UNIT
Supply Voltage	$V_{CC}$		2		5.5	V
Input Voltage	$V_{IN}$		0		5.5	V
Output Voltage	$V_{OUT}$	High or low state	0		$V_{CC}$	V
High-Level Input Voltage	$V_{IH}$	$V_{CC}=2.0V$	1.5			V
		$V_{CC}=3.0V$	2.1			
		$V_{CC}=5.5V$	3.85			
Low-Level Input Voltage	$V_{IL}$	$V_{CC}=2.0V$			0.5	V
		$V_{CC}=3.0V$			0.9	
		$V_{CC}=5.5V$			1.65	
High-Level Output Current	$I_{OH}$	$V_{CC}=2.0V$			-50	μA
		$V_{CC}=3.3V \pm 0.3V$			-4	mA
		$V_{CC}=5.0V \pm 0.5V$			-8	
Low-Level Output Current	$I_{OL}$	$V_{CC}=2.0V$			50	μA
		$V_{CC}=3.3V \pm 0.3V$			4	mA
		$V_{CC}=5.0V \pm 0.5V$			8	
Input Transition Rise or Fall Rate	$t_R, t_F$	$V_{CC}=3.3V \pm 0.3V$			100	ns/V
		$V_{CC}=5.0V \pm 0.5V$			20	

## ■ ELECTRICAL CHARACTERISTICS

PARAMETER	SYMBOL	TEST CONDITIONS	MIN	TYP	MAX	UNIT
High-Level Output Voltage	$V_{OH}$	$V_{CC}=2.0V, I_{OH}=-50\mu A$	1.9	2.0		V
		$V_{CC}=3.0V, I_{OH}=-50\mu A$	2.9	3.0		
		$V_{CC}=4.5V, I_{OH}=-50\mu A$	4.4	4.5		
		$V_{CC}=3.0V, I_{OH}=-4mA$	2.58			
		$V_{CC}=4.5V, I_{OH}=-8mA$	3.94			
Low-Level Output Voltage	$V_{OL}$	$V_{CC}=2.0V, I_{OH}=50\mu A$			0.1	V
		$V_{CC}=3.0V, I_{OH}=50\mu A$			0.1	
		$V_{CC}=4.5V, I_{OH}=50\mu A$			0.1	
		$V_{CC}=3.0V, I_{OH}=4mA$			0.36	
		$V_{CC}=4.5V, I_{OH}=8mA$			0.36	
Input Leakage Current	$I_{I(LEAK)}$	$V_{CC}=0 \sim 5.5V, V_{IN}=5.5V$ or GND			±0.1	μA
Quiescent Supply Current	$I_Q$	$V_{CC}=5.5V, V_{IN}=V_{CC}$ or GND, $I_{OUT}=0A$			1	μA
Input Capacitance	$C_I$	$V_{CC}=5.0V, V_{IN}=V_{CC}$ or GND		2	10	pF

■ DYNAMIC CHARACTERISTICS

PARAMETER	SYMBOL	TEST CONDITIONS	MIN	TYP	MAX	UNIT
Propagation Delay Time Input(A or B) to Output(Y)	$t_{PLH}$	$V_{CC}=3.3V\pm 0.3V, C_L=15pF$		5.5	7.9	ns
	$t_{PHL}$			5.5	7.9	
	$t_{PLH}$	$V_{CC}=3.3V\pm 0.3V, C_L=50pF$		8	11.4	
	$t_{PHL}$			8	11.4	
Propagation Delay Time Input(A or B) to Output(Y)	$t_{PLH}$	$V_{CC}=5V\pm 0.5V, C_L=15pF$		3.8	5.5	ns
	$t_{PHL}$			3.8	5.5	
	$t_{PLH}$	$V_{CC}=5V\pm 0.5V, C_L=50pF$		5.3	7.5	
	$t_{PHL}$			5.3	7.5	

■ OPERATING CHARACTERISTICS ( $T_a=25^\circ C$ )

PARAMETER	SYMBOL	TEST CONDITIONS	MIN	TYP	MAX	UNIT
Power Dissipation Capacitance	$C_{PD}$	No load, $V_{CC}=5V, f=1MHz$		14		pF

## ■ TEST CIRCUIT AND WAVEFORMS

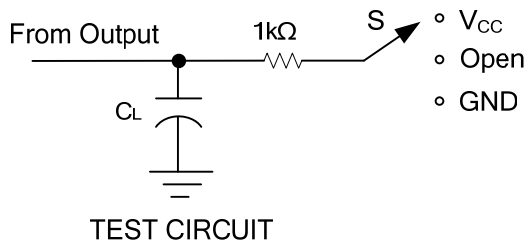

TEST	S
t <sub>PLH</sub> /t <sub>PHL</sub>	Open
t <sub>PHZ</sub> /t <sub>PZH</sub>	GND
t <sub>PLZ</sub> /t <sub>PZL</sub>	V <sub>CC</sub>

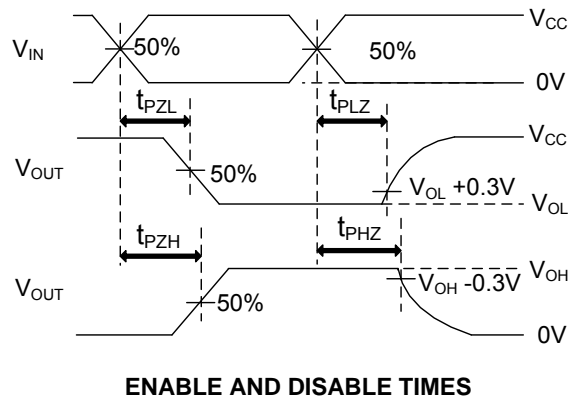
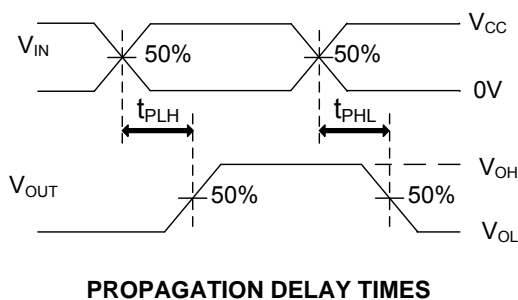
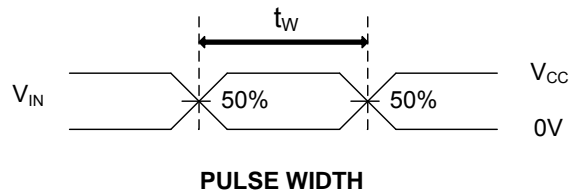
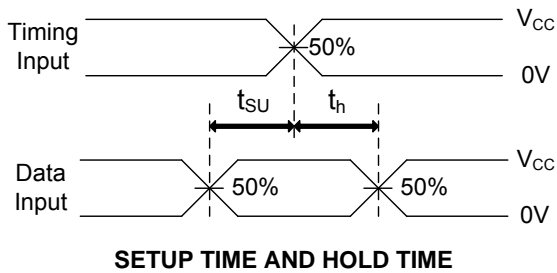

Note: C<sub>L</sub> includes probe and jig capacitance.  
 P<sub>RR</sub> ≅ 1MHz, Z<sub>O</sub> = 50Ω, t<sub>r</sub> ≅ 3ns, t<sub>f</sub> ≅ 3ns

UTC assumes no responsibility for equipment failures that result from using products at values that exceed, even momentarily, rated values (such as maximum ratings, operating condition ranges, or other parameters) listed in products specifications of any and all UTC products described or contained herein. UTC products are not designed for use in life support appliances, devices or systems where malfunction of these products can be reasonably expected to result in personal injury. Reproduction in whole or in part is prohibited without the prior written consent of the copyright owner. The information presented in this document does not form part of any quotation or contract, is believed to be accurate and reliable and may be changed without notice.