

General Specifications

Electrical Capacity (Resistive Load)

Logic Level: 0.4VA maximum @ 28V AC/DC maximum
(Applicable Range 0.1mA ~ 0.1A @ 20mV ~ 28V)
Note: Find additional explanation of operating range in Supplement section.

Other Ratings

Contact Resistance: 50 milliohms maximum
Insulation Resistance: 500 megohms minimum @ 500V DC
Dielectric Strength: 500V AC minimum between contacts for 1 minute minimum;
500V AC minimum between contacts & case for 1 minute minimum
Mechanical Life: 100,000 operations minimum for On-None-On & On-Off-On
50,000 operations minimum for other circuits
Electrical Life: 50,000 operations minimum
Nominal Operating Force: 1.47N (momentary); 1.18N (maintained) for .394" (10.0mm) toggles
2.73N (momentary); 1.84N (maintained) for all other toggles
Contact Timing: Nonshorting (break-before-make)
Angle of Throw: 26°

Materials & Finishes

Toggle: Glass fiber reinforced polyamide for antistatic; nickel plated brass for all others
Case Housing: Glass fiber reinforced polyamide
Support Bracket: Tin plated phosphor bronze
Movable Contact: Phosphor bronze with gold plating
Stationary Contacts: Brass with gold plating
Terminals: Brass with gold plating

Environmental Data

Operating Temperature Range: -30°C through +85°C (-22°F through +185°F)
Humidity: 90 ~ 95% humidity for 240 hours @ 40°C (104°F)
Vibration: 10 ~ 55Hz with peak-to-peak amplitude of 1.5mm traversing the frequency range & returning in 1 minute; 3 right angled directions for 2 hours
Shock: 50G (490m/s²) acceleration (tested in 6 right angled directions, with 5 shocks in each direction)

PCB Processing

Soldering: Wave Soldering Recommended. See Profile A in Supplement section.
Manual Soldering: See Profile B in Supplement section.
Cleaning: Automated cleaning. See Cleaning Specifications in Supplement section.

Standards & Certifications

The A Series toggles have not been tested for UL recognition or CSA certification. These switches are designed for use in a low-voltage, low-current, logic-level circuit. When used as intended in a logic-level circuit, the results do not produce hazardous energy.

Distinctive Characteristics

Subminiature size saves space on PC boards.

Specifically developed for logic-level applications.

Totally sealed body construction prevents contact contamination and allows time- and money-saving automated soldering and cleaning.

Award-winning STC contact mechanism with benefits unavailable in conventional mechanisms: smoother, positive detent actuation, increased contact stability and unparalleled logic-level reliability. (Additional STC details in Terms & Acronyms; see Supplement contents.)

Molded-in, epoxy sealed or ultrasonically welded terminals lock out flux, solvents, and other contaminants.

.100" x .100" (2.54mm x 2.54mm) terminal spacing conforms to standard PC board grid spacing.

Toggle option in antistatic material available for dissipating electrostatic discharges.

Matching indicators available.

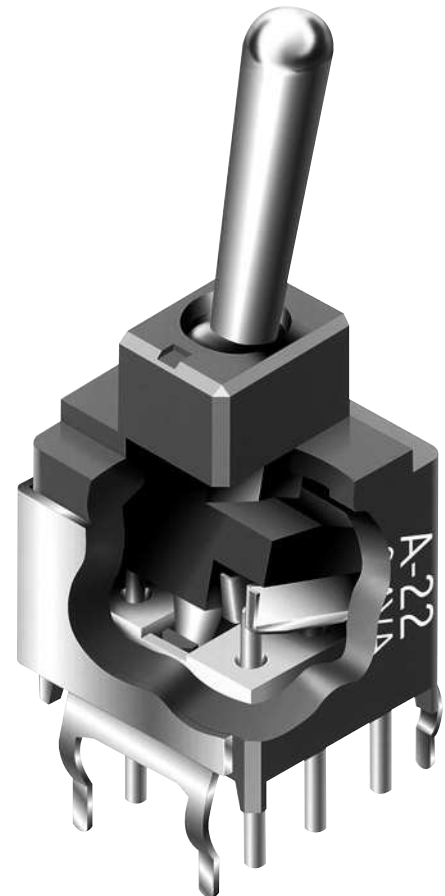

Actual Size

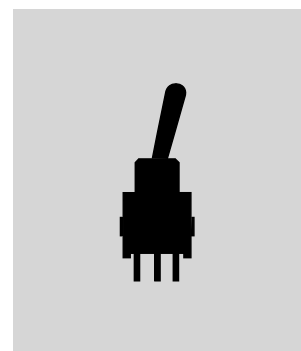



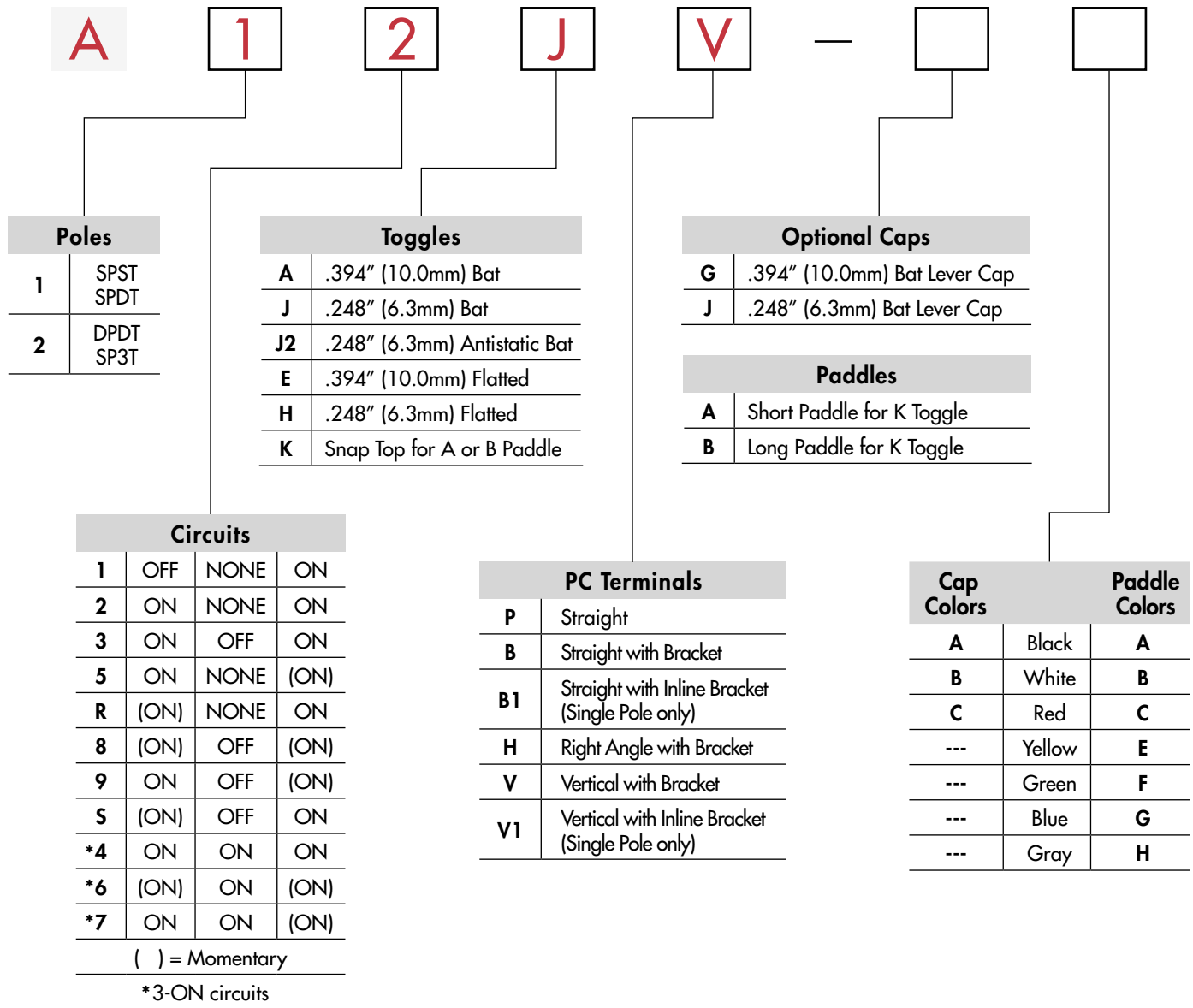





TYPICAL SWITCH ORDERING EXAMPLE



DESCRIPTION FOR TYPICAL ORDERING EXAMPLE

A12JV

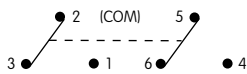

POLES & CIRCUITS								
Pole	Model	Toggle Position () = Momentary			Connected Terminals			Throw & Schematics
		Up 	Center 	Down 	Up 	Center 	Down 	
SP	A11	OFF	NONE	ON	OPEN	OPEN	3-1	SPST 
SP	A12 A13 A15 A1R A18 A19 A1S	ON ON ON (ON) (ON) ON (ON)	NONE OFF NONE NONE OFF OFF OFF	ON ON (ON) ON (ON) (ON) ON	2-3	OPEN	2-1	SPDT 
DP	A22 A23 A25 A2R A28 A29 A2S	ON ON ON (ON) (ON) ON (ON)	NONE OFF NONE NONE OFF OFF OFF	ON ON (ON) ON (ON) (ON) ON	2-3 5-6	OPEN	2-1 5-4	DPDT 

For 3 Throw (3-on)

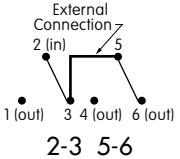
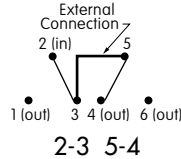
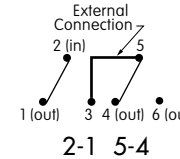
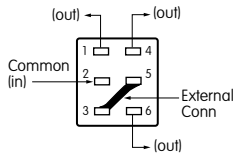
Connected Terminals & Schematics					External Connection
Pole	Model	Up	Center	Down	
SP	A24 A26 A27	ON (ON) ON 	ON ON ON 	ON (ON) (ON) 	The SP3T model utilizes a double pole base. External connections must be made during field installation. 

TOGGLES

Standard Material & Finish: Brass with Bright Nickel Material & Finish for J2: Matte finish black glass fiber reinforced polyamide

A .394" (10.0mm) Bat

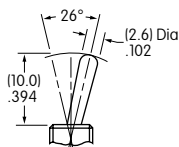

J .248" (6.3mm) Bat

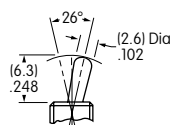

J2 .248" (6.3mm) Antistatic Bat

Dissipating 20Kv ESD: Straight PC
Dissipating 10Kv ESD: Straight PC with Bracket, Right Angle, & Vertical

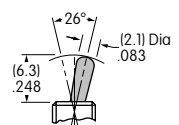

E .394" (10.0mm) Flatted

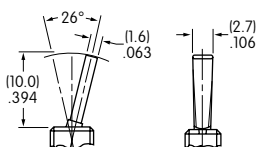

H .248" (6.3mm) Flatted

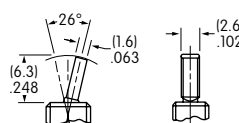

K Snap Top for Paddles

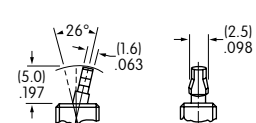

PC TERMINALS

Use of a support bracket is recommended to increase PCB mounting strength and stability.

P Straight

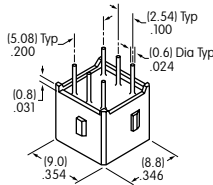

B Straight with Bracket

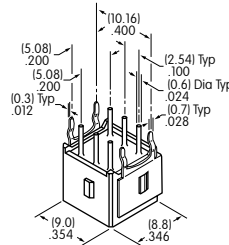

B1 Straight with Inline Bracket
Single Pole only

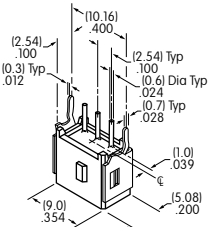

H Right Angle
with Bracket

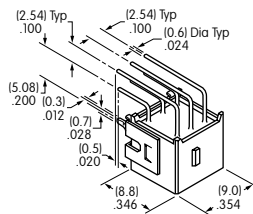

V Vertical with Bracket

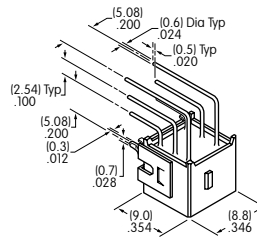

V1 Vertical with Inline Bracket
Single Pole only

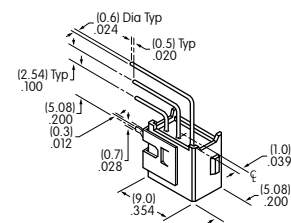

CAPS & PADDLES

G AT4003
.394" (10.0mm) Bat Lever Cap

Material: PVC
Colors Available:
A, B, C

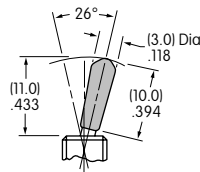

J AT4064
.248" (6.3mm) Bat Lever Cap

Material: PVC
Colors Available:
A, B, C

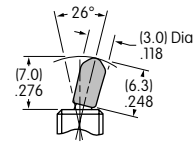

A AT467
Short Paddle

Material: Polyamide
Colors Available:
A, B, C, E, F, G, H

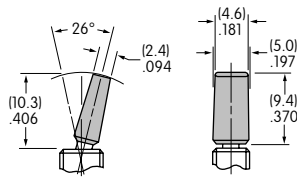

B AT468
Long Paddle

Material: Polyamide
Colors Available:
A, B, C, E, F, G, H

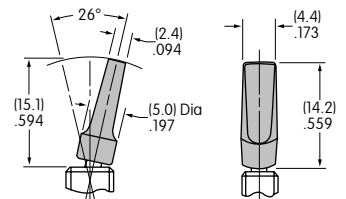

Color Codes:

- A** Black
- B** White
- C** Red
- E** Yellow
- F** Green
- G** Blue
- H** Gray

TYPICAL SWITCH DIMENSIONS

Single Pole

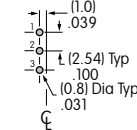
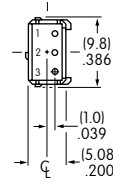
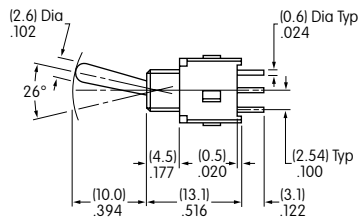
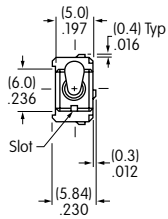

Straight PC



A11 models do not have Terminal 2

A12AP

Double Pole

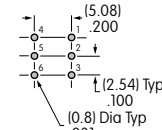
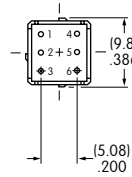
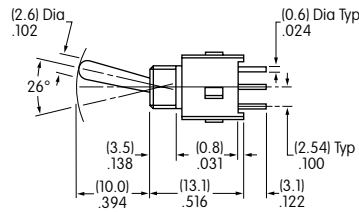
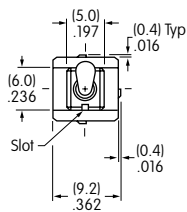

Straight PC



A22AP

Single Pole

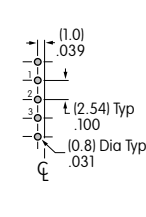
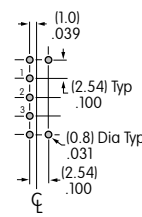
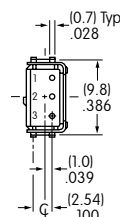
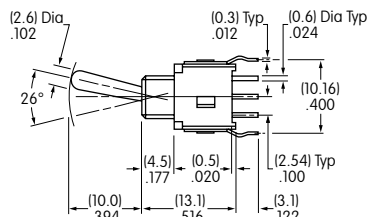
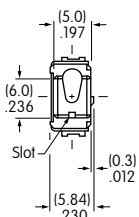

Straight PC • Bracket



B Terminals

B1 Terminals

A12AB

Double Pole

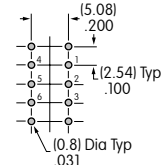
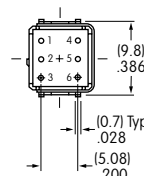
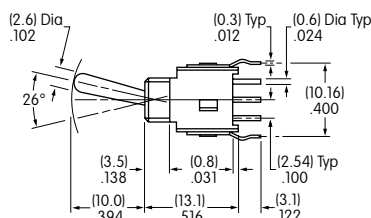
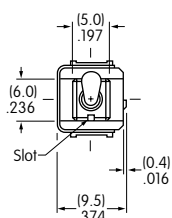

Straight PC • Bracket



A22AB

TYPICAL SWITCH DIMENSIONS

Rockers

Pushbuttons

Illuminated PB

Programmable

Keylocks

Rotaries

Slides

Tactiles

Tilt

Touch

Indicators

Accessories

Supplement

Right Angle PC

Single Pole

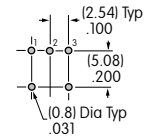
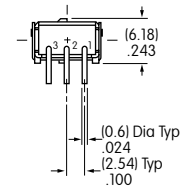
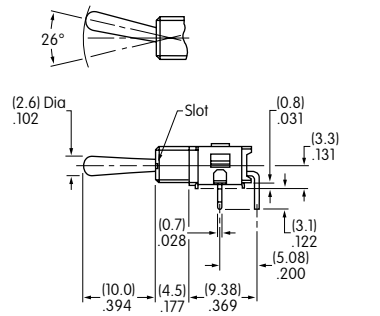
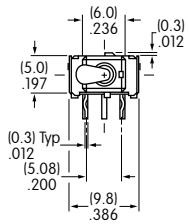

A12AH

Right Angle PC

Double Pole

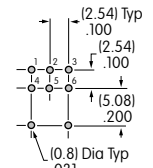
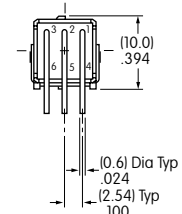
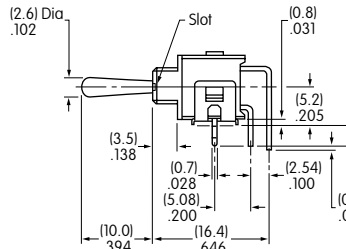
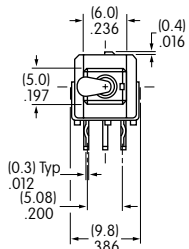

A22AH

Vertical PC

Single Pole

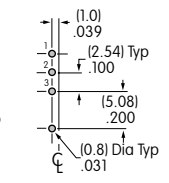
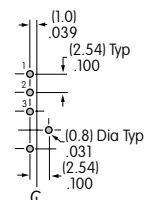
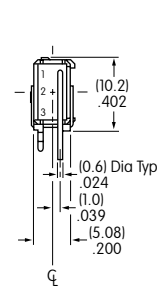
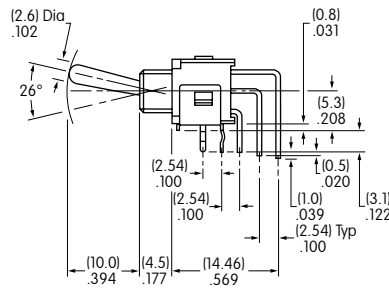
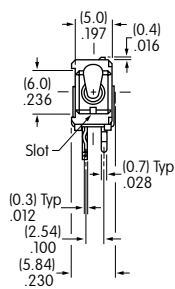

A12AV

V Terminals

V1 Terminals

Vertical PC

Double Pole

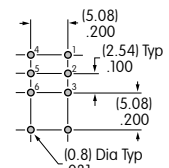
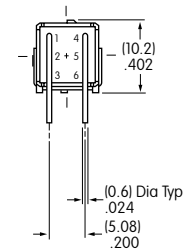
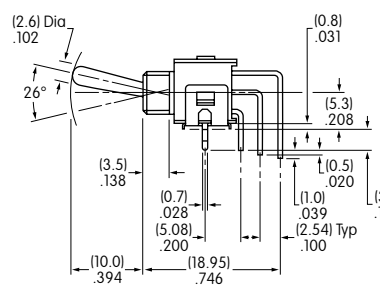
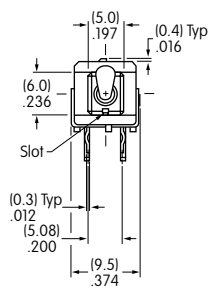

A22AV