

SPECIFICATIONS:

ELECTRICAL:

INSULATOR RESISTANCE: 5 G OHMS Min.
 DIELECTRIC WITHSTANDING: 1,000VAC r.m.s.
 OPERATING TEMPERATURE: -55° C ~ +125° C
 POWER CONTACT RESISTANCE: 1.0 Milliohms Max.
 SIGNAL CONTACT RESISTANCE: 2.7 Milliohms Max.
 POWER PINS: 40 AMPS
 SIGNAL PINS: 5 AMPS

MECHANICAL:

CONTACT INSERTION FORCE: 4.5 Kg Max.
 CONTACT SEPARATOR FORCE: 0.3Kg Min.

MATERIALS:

CONTACTS: COPPER ALLOY
 INSULATOR: PBT UL94V-0 RATED, BLK 230°C PROCESS TEMP.
 SHELL: STEEL
 BOARD LOCK: BRASS, NICKEL PLATED
 CINCHNUT: BRASS, NICKEL PLATED
 BRACKET: STEEL, NICKEL PLATED

FINISH:

SHELL: NICKEL
 CONTACTS: FULL GOLD FLASH

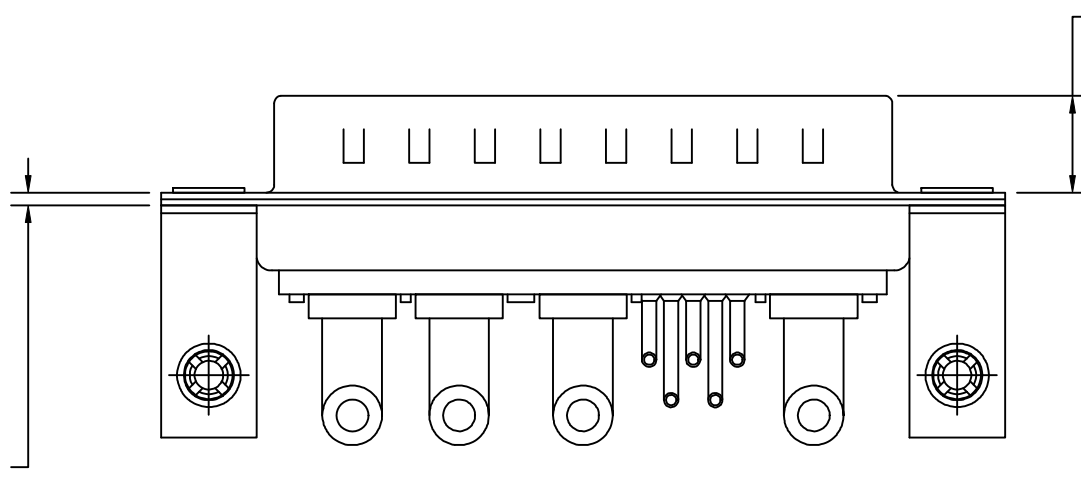
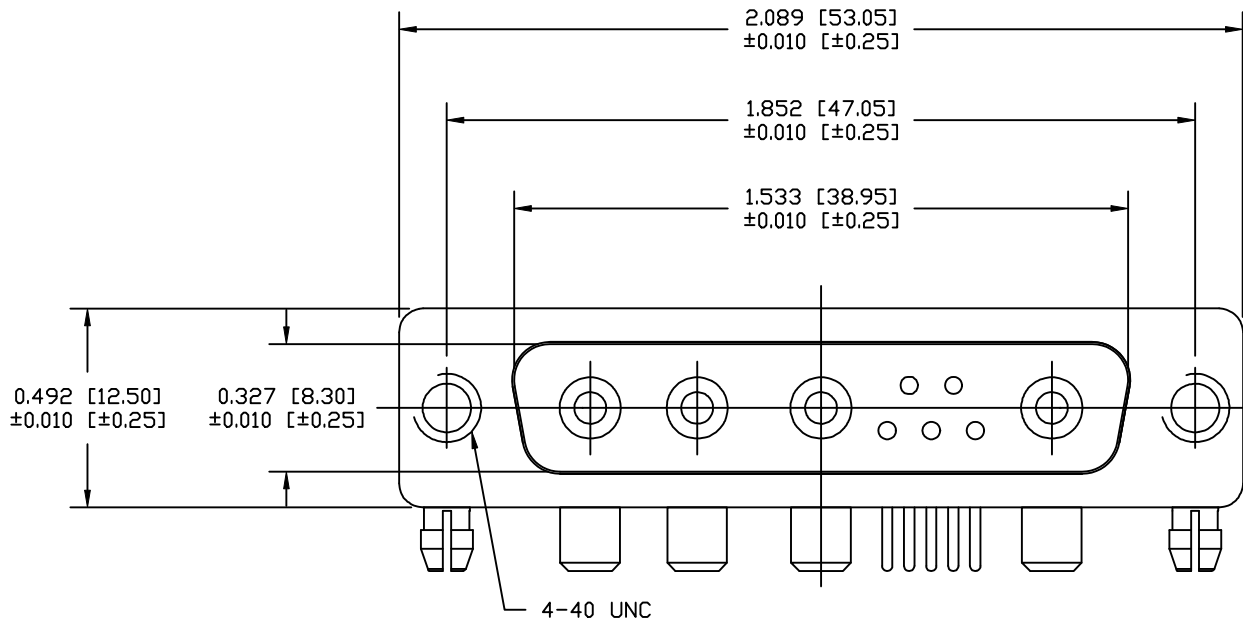

684M9W4103L461

46 = 4-40 INSERTS / BOARD LOCKS

DO NOT SCALE FROM DRAWING

RoHS COMPLIANT

	THESE DRAWINGS AND SPECIFICATIONS ARE THE PROPERTY OF NorComp AND SHALL NOT BE REPRODUCED, COPIED OR USED AS THE BASIS FOR THE MANUFACTURE OF SALE OF APPARATUS WITHOUT WRITTEN PERMISSION.		DRAWN: M. SIGMON	DATE: 08-20-12
	<h1>NorComp</h1>		CHECKED:	DATE:
SCALE: N.T.S.			SHEET 1 OF 2	REV 2
			DWG NO. 684M9W4103L461	

**NOTE:
POWER CONTACTS COME
PRE-LOADED INTO INSULATORS**

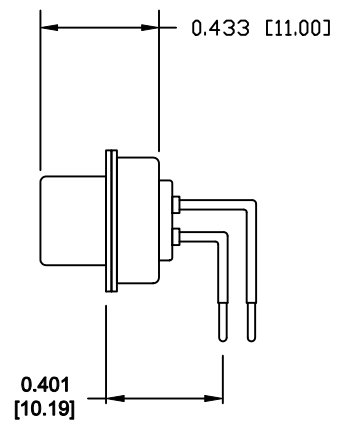
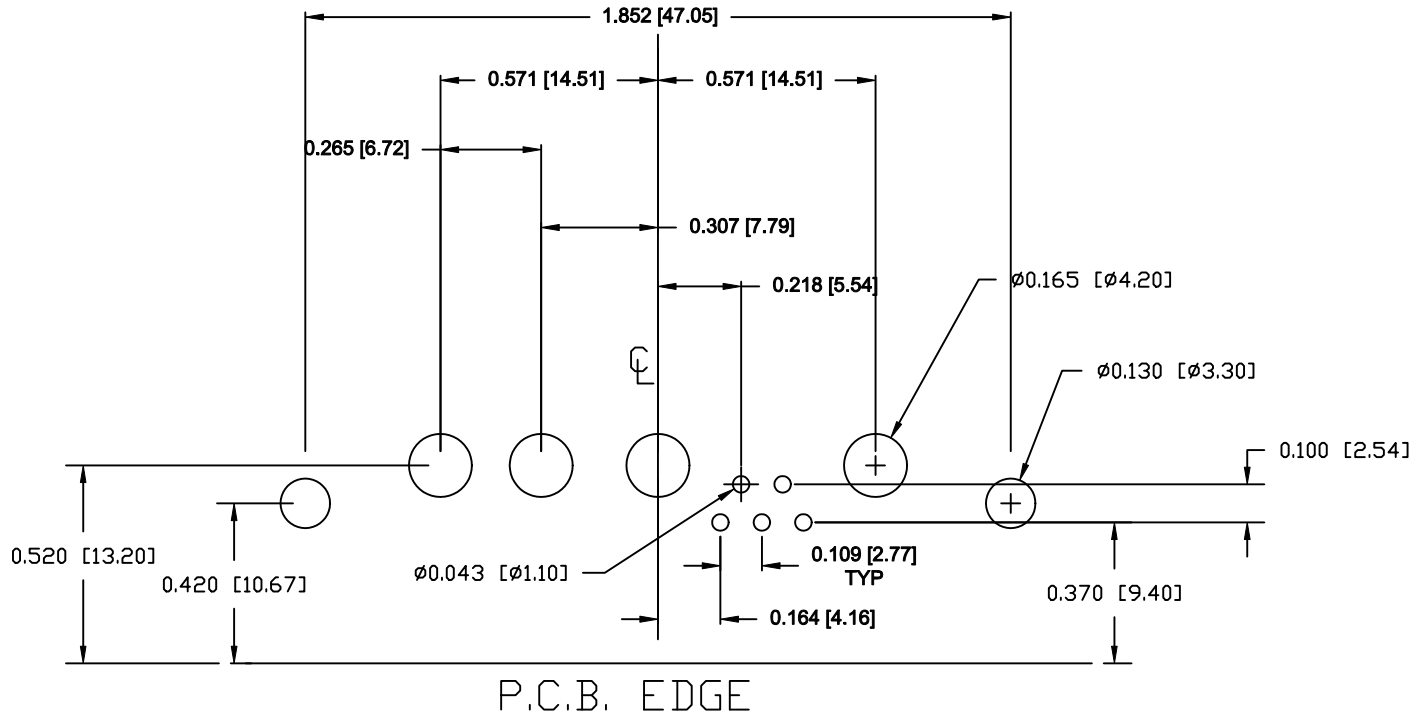

SIGNAL CONTACTS

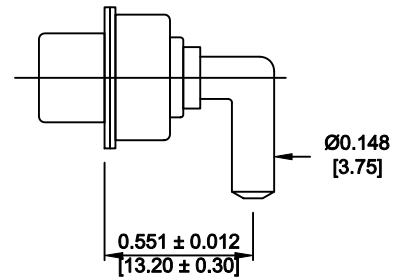

40 AMP POWER CONTACT

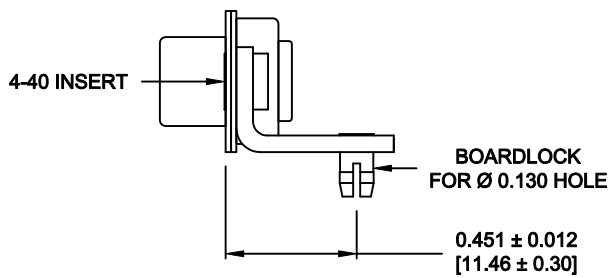

MOUNTING HARDWARE

DO NOT SCALE FROM DRAWING

	THESE DRAWINGS AND SPECIFICATIONS ARE THE PROPERTY OF NorComp AND SHALL NOT BE REPRODUCED, COPIED OR USED AS THE BASIS FOR THE MANUFACTURE OF SALE OF APPARATUS WITHOUT WRITTEN PERMISSION.		DRAWN: M. SIGMON	DATE: 08-20-12
			CHECKED:	DATE:

RoHS COMPLIANT

NorComp

SCALE: N.T.S.	SHEET 2	OF 2	REV 2
DWG NO. 684M9W4103L461			