

# SH CONNECTOR

1.0mm pitch/Disconnectable Crimp style connectors

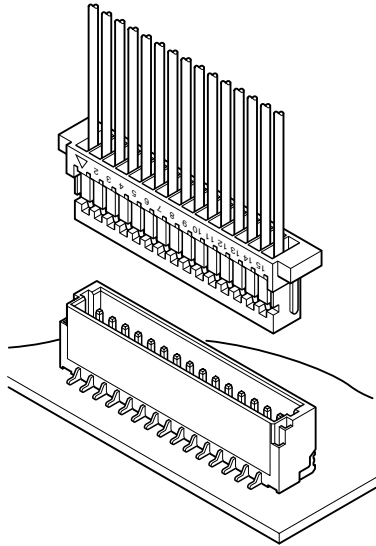

The world's first 1.0mm pitch crimp style connector.

- Compact, low profile design
- Compatible with the SR insulation displacement connectors
- Housing lances

## Specifications

- Current rating: 1.0A AC, DC (AWG #28)
  - Voltage rating: 50V AC, DC
  - Temperature range: -25°C to +85°C  
(including temperature rise in applying electrical current)
  - Contact resistance: Initial value/20m Ω max.  
After environmental testing/40m Ω max.
  - Insulation resistance: 100M Ω min.
  - Withstanding voltage: 500V AC/minute
  - Applicable wire: Conductor size/AWG #32 to #28  
Insulation O.D./0.4 to 0.8mm
- \* Compliant with RoHS.  
\* Refer to "General Instruction and Notice when using Terminals and Connectors" at the end of this catalog.  
\* Contact JST for details.

## Standards

- Ⓜ Recognized E60389
- Ⓢ Certified LR20812

## PC board layout (viewed from component side) and Assembly layout

### Top entry type

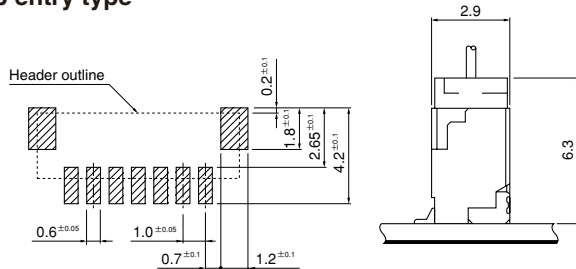

### Side entry type

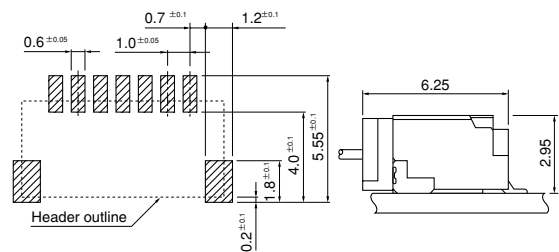

- Note: 1. Tolerances are non-cumulative: ±0.05mm for all centers.  
2. The dimensions above should serve as a guideline. Contact JST for details.

## Contact

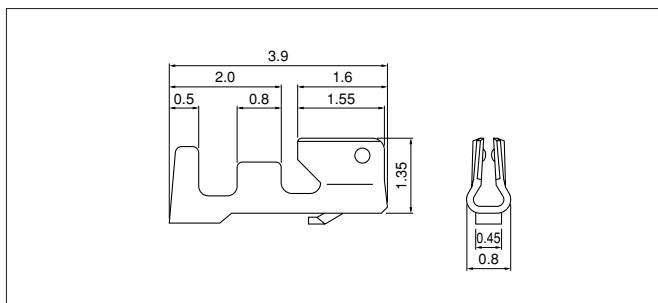

Model No.	Applicable wire			Q'ty / reel
	mm <sup>2</sup>	AWG#	Insulation O.D. (mm)	
SSH-003T-P0.2-H	0.032~0.08	32~28	0.4~0.8	23,000

### Material and Finish

Phosphor bronze, tin-plated (reflow treatment)

### RoHS compliance

Note: Contact JST for gold-plated products.

Contact	Crimping machine	Applicator		
		Crimp applicator	Dies	Crimp applicator with dies
SSH-003T-P0.2-H	AP-K2N	MKS-L-10-3	MK/SSH/L-003-02	APLMK SSH/L003-02
		*MKS-SC	SC/SSH/L-003-02	APLSC SSH/L003-02

Note: \*Strip-crimp applicator

Contact JST for applicable wires in case that it is not usable due to wire size.

# SH CONNECTOR

## Housing

### With protrusions

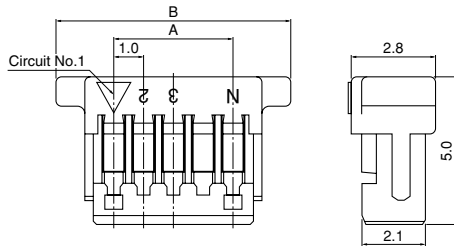

### Without protrusions

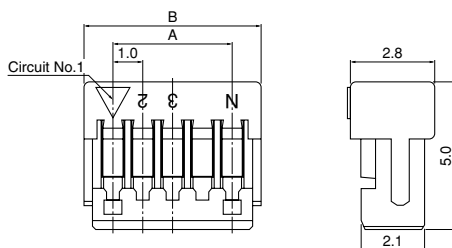

Circuits	Model No.		Dimensions (mm)			Q'ty / box
	With protrusions	Without protrusions	A	B		
2	SHR-02V-S-B	SHR-02V-S	1.0	5.0	3.0	2,000
3	SHR-03V-S-B	SHR-03V-S	2.0	6.0	4.0	2,000
4	SHR-04V-S-B	SHR-04V-S	3.0	7.0	5.0	2,000
5	SHR-05V-S-B	SHR-05V-S	4.0	8.0	6.0	2,000
6	SHR-06V-S-B	SHR-06V-S	5.0	9.0	7.0	2,000
7	SHR-07V-S-B	SHR-07V-S	6.0	10.0	8.0	2,000
8	SHR-08V-S-B	SHR-08V-S	7.0	11.0	9.0	2,000
9	SHR-09V-S-B	SHR-09V-S	8.0	12.0	10.0	2,000
10	SHR-10V-S-B	SHR-10V-S	9.0	13.0	11.0	2,000
11	SHR-11V-S-B	SHR-11V-S	10.0	14.0	12.0	2,000
12	SHR-12V-S-B	SHR-12V-S	11.0	15.0	13.0	2,000
13	SHR-13V-S-B	SHR-13V-S	12.0	16.0	14.0	2,000
14	SHR-14V-S-B	SHR-14V-S	13.0	17.0	15.0	2,000
15	SHR-15V-S-B	SHR-15V-S	14.0	18.0	16.0	2,000
20	SHR-20V-S-B	—	19.0	23.0	21.0	1,000

### Material

PBT, UL94V-0, natural (white)

### RoHS compliance

## Shrouded header

The shrouded headers are interchangeable with those of the SR insulation displacement connectors.

### Top entry type

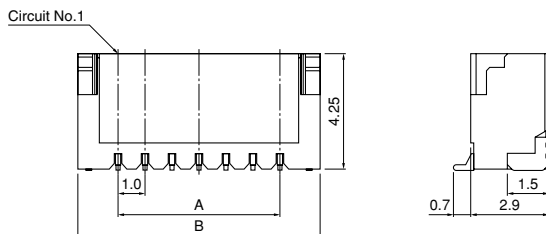

### Side entry type

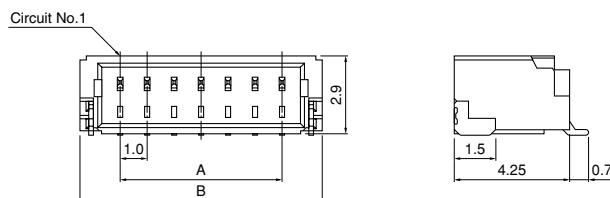

Circuits	Model No.		Dimensions (mm)		Q'ty / reel	
	Top entry type	Side entry type	A	B	Top entry type	Side entry type
2	BM02B-SRSS-TB	SM02B-SRSS-TB	1.0	4.0	1,500	3,000
3	BM03B-SRSS-TB	SM03B-SRSS-TB	2.0	5.0	1,500	3,000
4	BM04B-SRSS-TB	SM04B-SRSS-TB	3.0	6.0	1,500	3,000
5	BM05B-SRSS-TB	SM05B-SRSS-TB	4.0	7.0	1,500	3,000
6	BM06B-SRSS-TB	SM06B-SRSS-TB	5.0	8.0	1,500	3,000
7	BM07B-SRSS-TB	SM07B-SRSS-TB	6.0	9.0	1,500	3,000
8	BM08B-SRSS-TB	SM08B-SRSS-TB	7.0	10.0	1,500	3,000
9	BM09B-SRSS-TB	SM09B-SRSS-TB	8.0	11.0	1,500	3,000
10	BM10B-SRSS-TB	SM10B-SRSS-TB	9.0	12.0	1,500	3,000
11	BM11B-SRSS-TB	SM11B-SRSS-TB	10.0	13.0	1,500	3,000
12	BM12B-SRSS-TB	SM12B-SRSS-TB	11.0	14.0	1,500	3,000
13	BM13B-SRSS-TB	SM13B-SRSS-TB	12.0	15.0	1,500	3,000
14	BM14B-SRSS-TB	SM14B-SRSS-TB	13.0	16.0	1,500	3,000
15	BM15B-SRSS-TB	SM15B-SRSS-TB	14.0	17.0	1,500	3,000
20	—	SM20B-SRSS-TB	19.0	22.0	—	3,000

### Material and Finish

Contact: Copper alloy, copper-undercoated, tin-plated (reflow treatment)  
Housing: PA, UL94V-0, natural (ivory)  
Soldier tab: Brass, copper-undercoated, tin-plated (reflow treatment)

### RoHS compliance

This product displays (LF)(SN) on a label.  
Note: 1. The products listed above are supplied on embossed-tape.  
2. Contact JST for the headers with gold-plated pins.  
3. Contact JST for the top entry type headers with suction cap.