

AXIS Q1921/-E Thermal Network Cameras

High quality detection and wide range coverage.



- > Thermal imaging for IP-Surveillance
- > Lens alternatives for different applications
- > High-quality detection
- > Intelligent video capabilities
- > Power over Ethernet
- > Full duplex audio

AXIS Q1921/-E Thermal Network Cameras are a perfect complement to any network video system that needs to secure an area 24 hours a day, seven days a week. The cameras use thermal imaging, which allows users to detect people, objects and incidents in complete darkness and difficult conditions such as smoke, haze, dust and light fog.

AXIS Q1921 is intended for indoor environments, while AXIS Q1921-E is an out-of-the-box, outdoor-ready model with a built-in window heater that is designed to withstand harsh weather conditions.

A resolution of 384x288 and a range of lenses make it possible to optimize detection performance to meet most application requirements. Advanced software processing and a frame rate of up to 30 fps will further improve the thermal image quality.

Since thermal cameras are less sensitive to problems with light conditions and shadows, they can achieve higher accuracy than conventional cameras in most intelligent video applications.



AXIS Q1921/-E cameras offer motion detection and audio detection. The cameras also provide capacity for third-party analytics modules, including support for AXIS Camera Application Platform. AXIS Q1921/-E cameras support ONVIF for interoperability between network video products.

Installation is made easy and cost effective with Power over Ethernet (IEEE 802.3af). AXIS Q1921/-E cameras support H.264 video compression, which reduces bandwidth usage and storage needs. The cameras provide multiple, individually configurable video streams in H.264 and Motion JPEG.



Range Chart

Wide range coverage for AXIS Q1921/-E

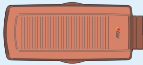
	Focal length	Viewing angle	Human: 1.8 x 0.5 m Critical dimension: 0.75 m		Vehicle: 1.4 x 4.0 m Critical dimension: 2.3 m	
						
	mm	Horizontal	meters	yards	meters	yards
Detection (1.5 pixels on target) An observer can see an object 	10	51°	220	241	660	722
	19	28°	390	427	1200	1312
	35	16°	700	766	2200	2405
	60	9°	1200	1312	3700	4046
Recognition (6 pixels on target) An observer can distinguish an object	10	51°	55	60	170	186
	19	28°	100	109	300	328
	35	16°	175	191	550	601
	60	9°	300	330	920	1006
Identification (12 pixels on target) An observer can distinguish a specific object	10	51°	25	27	85	93
	19	28°	50	55	150	164
	35	16°	90	98	270	295
	60	9°	150	165	460	503

According to Johnson's criteria. The ranges vary in different weather conditions.

Environmental considerations

Johnson's criteria assume ideal conditions. The weather conditions at site will affect the thermal energy emitted from the object and decrease the effective detection range. The detection range in the tables above ideally requires a temperature difference of 2° C between the targeted object and the background. However, the weather conditions such as rain, snow and fog will attenuate the radiated energy from the object since the heat radiation from the object is scattered when it hits particles in the air. To avoid performance and reliability problems always test the camera in the actual environment where it needs to be used.

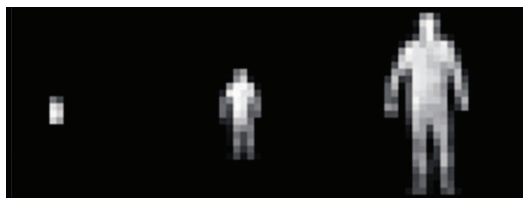

The difference in number of pixels between detection, recognition and identification illustrated with a human target.

Integration of intelligent applications

The sensor in a thermal camera reacts to differences in thermal energy. Thus, the sensor is less sensitive to changing light conditions, darkness and other challenging conditions. This makes thermal cameras a perfect platform to integrate intelligent video applications to build more efficient 24/7 surveillance systems. Through our Application Development Partner Program Axis can offer the widest range of third party applications available.

Integrated with intelligent video applications such as video motion detection or tripwire, the camera can automatically trigger an alert to the operator. To maximize performance of the application and safeguard reliable operation 6 pixels across the object is recommended and the surrounding environment always needs to be considered.

Technical specifications – AXIS Q1921/-E Thermal Network Cameras

Camera		System integration	
Models	Indoor: AXIS Q1921, 10 mm and 19 mm Outdoor: AXIS Q1921-E, 10 mm, 19 mm, 35 mm and 60 mm	Application Programming Interface	Open API for software integration, including the ONVIF specification available at www.onvif.org , as well as VAPIX® and AXIS Camera Application Platform from Axis Communications, specifications available at www.axis.com Support for Axis Video Hosting system (AVHS) with One-Click Camera connection
Image sensor	Uncooled Micro bolometer 384x288, pixel size: 25 µm, spectral range: 8-14µm	Intelligent video	Video motion detection, active tampering alarm, audio detection. Support for AXIS Camera Application Platform enables installation of additional applications
Sensitivity	NETD < 100 mK	Alarm triggers	Intelligent video and external input
Video		Alarm events	File upload via FTP, HTTP and email; notification via email, HTTP and TCP; external output activation, pre- and post- alarm video buffering
Video compression	H.264 (MPEG-4 Part 10/AVC) Motion JPEG	General	
Resolutions	Sensor is 384x288. Image can be scaled up to 768x576 and to standard VGA resolutions	Casing	AXIS Q1921: Zinc chassis AXIS Q1921-E: IP66-rated aluminum casing and a germanium window
Standard frame rate	Up to 30 fps within EU, Norway, Switzerland, Canada, USA, Japan, Australia, New Zealand Up to 8.3 fps in other countries* <i>*Frame rate above 9 fps may be subject to export control regulations</i>	Memory	128 MB RAM, 128 MB Flash
Video streaming	At least 3 H.264 and Motion JPEG streams using the same palette, simultaneous and individually configured in max. resolution at 30 fps. Controllable frame rate and bandwidth. VBR/CBR H.264	Power	Power over Ethernet IEEE 802.3af Class 3 AXIS Q1921: 8-20 V DC, max 7 W or 20-24 V AC 50-60 Hz, max 13 VA, power supply not included AXIS Q1921-E: 8-20 V DC, max 12 W or 20-24 V AC 50-60 Hz, max 18 VA, power supply not included
Image settings	Compression, brightness, exposure control, rotation, mirroring of images, text and image overlay, privacy mask, palettes	Connectors	RJ-45 10BASE-T/100BASE-TX PoE, terminal block for power, terminal block for two configurable inputs/outputs 3.5 mm mic/line in, 3.5 mm line out RS-422/RS-485 AXIS Q1921/-E: Terminal block for heater
Audio		Edge storage	SD/SDHC memory card slot (card is not included)
Audio streaming	Two-way, full duplex	Operating conditions	-40 °C to +60 °C (-40 °F to 140 °F) AXIS Q1921: Humidity 20-80% RH (non-condensing) AXIS Q1921-E: Humidity 10-85% RH
Audio compression	AAC LC 8/16 kHz, G.711 PCM 8 kHz, G.726 ADPCM 8 kHz Configurable bit rate	Approvals	EN 55022 Class B, EN 61000-3-2, EN 61000-3-3, EN 55024, EN50121-4, EN 61000-6-1, EN 61000-6-2, EN 60950-1, KC Class B, FCC Part 15 Subpart B Class B, VCCI Class B ITE IEC TR 60721-4-3 3M4/-4-4 4M4 (shock/vibration) IEC 60529 IP66
Audio input/output	AXIS Q1921: Built-in microphone, external microphone or line input, line output AXIS Q1921-E: External microphone or line input, line output	Weight	AXIS Q1921: 950 g (2.10 lb.) - 970 g (2.14 lb.) AXIS Q1921-E: 3475 g (7.66 lb.) - 3650 g (8.05 lb.)
Network		Included accessories	Connector kit, Installation Guide, CD with User's Manual, recording software, installation and management tools, Windows decoder 1-user license AXIS Q1921-E: wall mount bracket, 5 m (16 ft.) Ethernet cable
Security	Password protection, IP address filtering, HTTPS** encryption, IEEE 802.1X** network access control, digest authentication, user access log		
Supported protocols	IPv4/v6, HTTP, HTTPS SSL/TLS**, QoS Layer 3 DiffServ, FTP, SMTP, Bonjour, UPnP, SNMPv1/v2c/v3(MIB-II), DNS, DynDNS, NTP, RTSP, RTP, TCP, UDP, IGMP, RTCP, ICMP, DHCP, ARP, SOCKS. Wide range of PT heads supported (drivers available for download at www.axis.com).		

**This product includes software developed by the OpenSSL Project for use in the OpenSSL Toolkit. (www.openssl.org)

More information is available at www.axis.com

Dimensions: AXIS Q1921 Thermal Network Camera

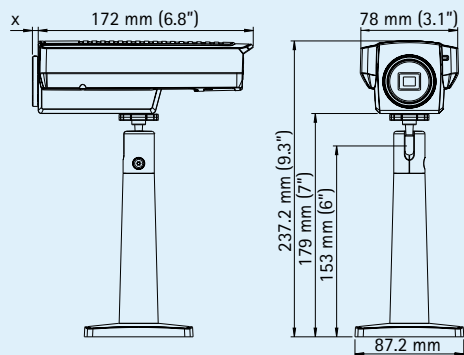

(X)= Lens length (mm/inch)	Lens focal length (mm)
18/0.7	10
14/0.5	19
38/1.5	35
55/2.2	60

Dimensions: AXIS Q1921-E Thermal Network Camera and wall mount bracket with internal cable channel

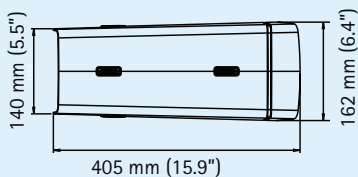
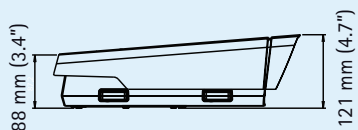

With sunshield

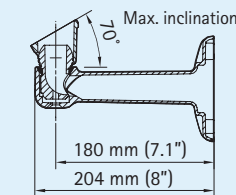
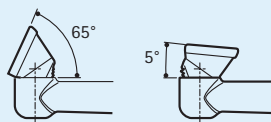

Wall mount arm

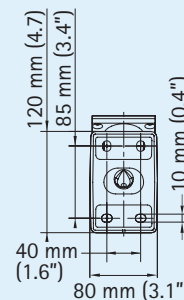

Back side of wall mount bracket

Optional accessories

AXIS PoE Midspan 1-port



YP3040 Pan-Tilt Motor



Lenses



AXIS T8412 Installation Display

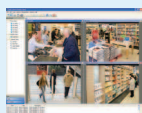

For information on AXIS Camera Station and video management software from Axis' Application Development Partners, see www.axis.com/products/video/software/

Optional mounting accessories for outdoor models

Wall bracket accessories

Adapter plate



Pole mount



Corner mount adapter



Ceiling brackets with ball joint



Column mount with ball joint

