

AXIS P5544 PTZ Dome Network Camera

HDTV PTZ dome with 360° panoramic view and 18x zoom.



- > PTZ with 360° panoramic view and 18x optical zoom
- > HDTV 720p and H.264
- > IP51-rated protection against dust and dripping water
- > Advanced Gatekeeper
- > PoE+ (IEEE 802.3at)

AXIS P5544 PTZ Dome Network Camera is a unique indoor HDTV pan/tilt/zoom dome with 360° panoramic view and 18x optical zoom. It is ideal for live monitoring applications at airports, train stations, logistics centers, museums and big retail stores.

AXIS P5544 provides a 360° field of view that covers more than 950 m² (10,000 sq. ft.)—more than the size of three tennis courts—enabling panoramic views not only for security purposes, but also for crowd, flow and queue management.

With the capability to also pan 360°, tilt 180° and optically zoom in 18x, the camera enables flexible coverage over a wide area and sharp zoomed-in views for identification purposes in HDTV 720p.

Using Axis' unique Panopsis technology, AXIS P5544 incorporates two different lenses to ensure that there is no loss in image quality, whether in the 360° panoramic view or zoomed-in view.

The camera's day/night functionality ensures high image quality in both daylight and low light conditions. Multiple streams in H.264 and Motion JPEG formats are supported.

AXIS P5544 provides Advanced Gatekeeper, which enables the camera to automatically move to a preset position when motion is detected in a pre-defined area.

Two-way audio, audio detection and inputs/outputs for external devices are supported when an optional multi-connector cable is used.

The IP51-rated camera also supports Power over Ethernet Plus (PoE+) for easy installation.



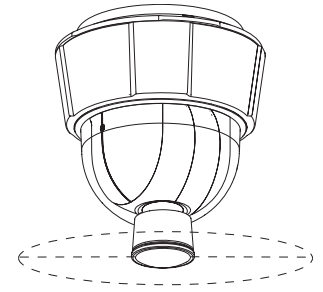
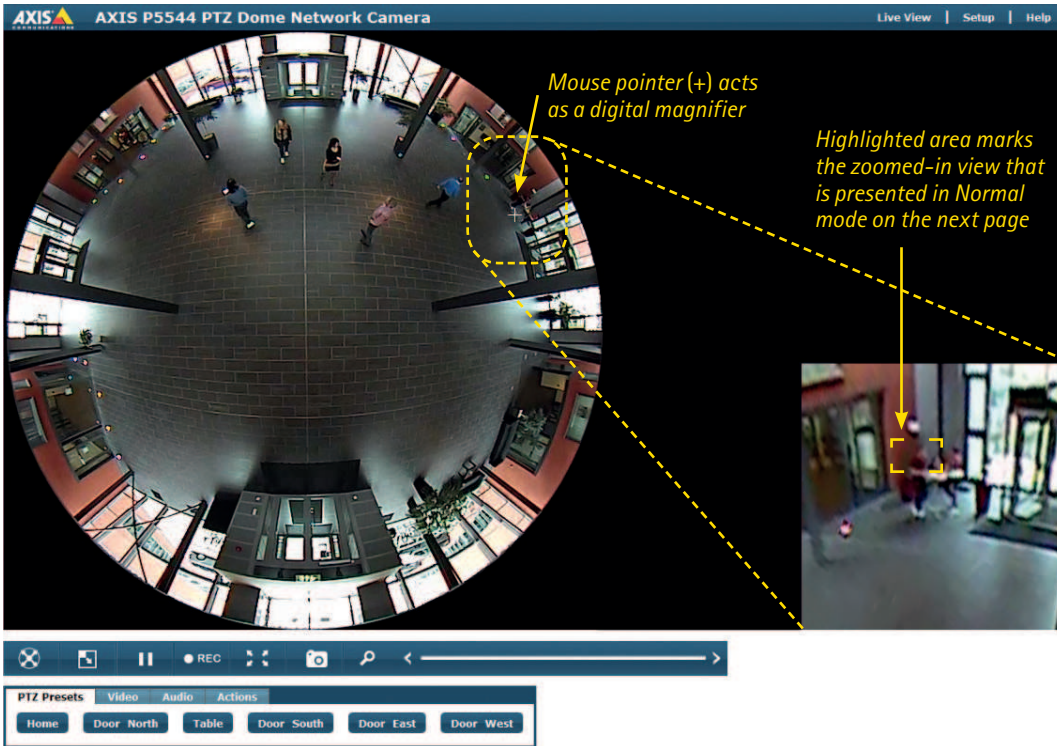

Left:
Actual screenshot of
AXIS P5544 user interface in
Overview mode. The indoor
area covered by this
panoramic view is about
650 m² (7000 sq. ft.).

High image quality maintained in 360° overview and zoomed-in view

AXIS P5544 incorporates two different lenses. The camera uses a zoom lens in pan/tilt/zoom functions to deliver normal 16:9 views. When the zoom lens points straight down, it looks through the Panopsis lens (a wide-angle converter) to provide high-resolution 360° panoramic overviews. The camera records video either in normal view or 360° overview, not both simultaneously.

In Overview mode, the camera's user interface enables the mouse pointer—which appears as a white cross in the image above—to act as a digital magnifier. By moving the mouse to any part in the live Overview, a dewarped, digitally magnified view of the area is presented in the

right-hand corner of the interface. Clicking on any area of the Overview image or drawing a rectangle around the area to be magnified (Area zoom) will steer the camera's zoom lens to the area, and video in normal view will be provided.

The camera will also go over to normal view when clicking on any PTZ preset button that has been defined (see bottom row in the image above). A preset button defines the camera's coordinates, including the zoom position.

Optional accessories

AXIS T91A Mounting Accessories

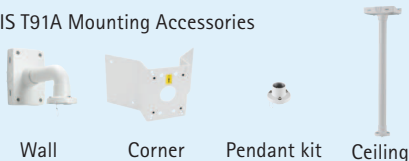

AXIS T90A Illuminators



AXIS T8310 Video Surveillance Control Board



AXIS T81B22 DC 30 W Midspan



Multi-connector cable for AC/DC power, I/Os and audio

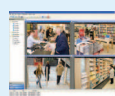

AXIS Camera Companion, AXIS Camera Station and video management software from Axis' Application Development Partners. For more information, see www.axis.com/products/video/software/

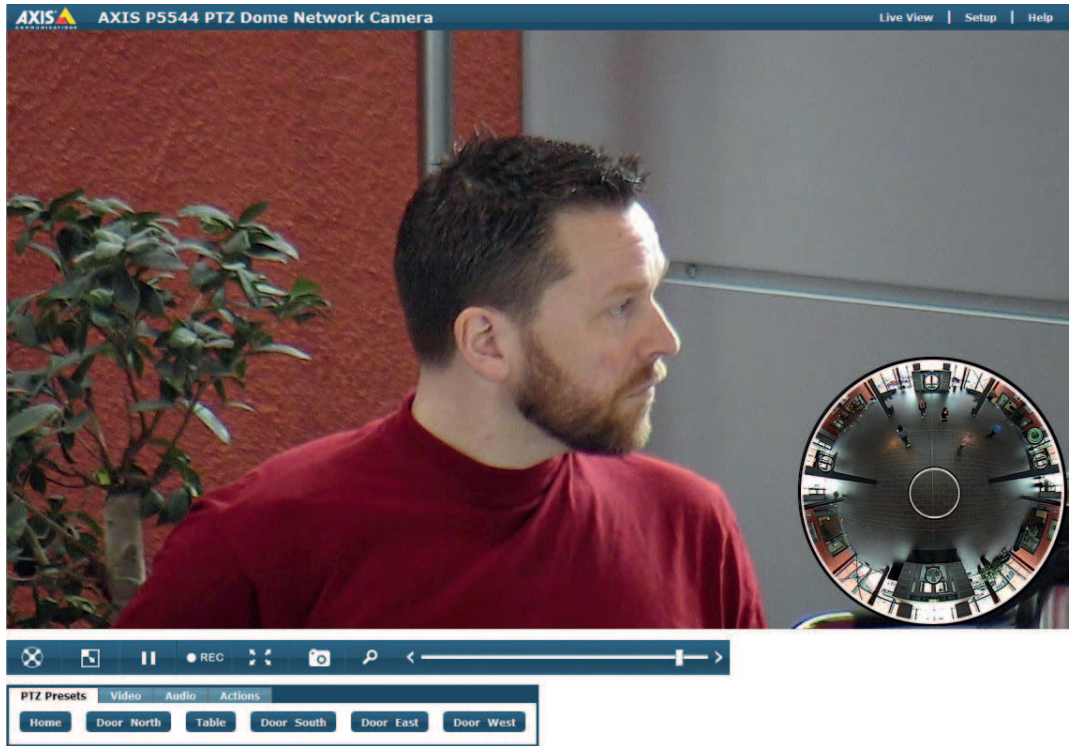
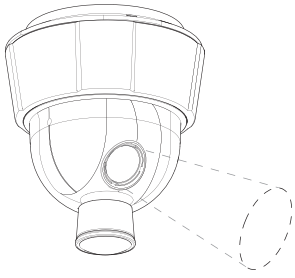

Right:
Actual screenshot of
AXIS P5544 user interface in
Normal mode. It shows a zoomed-in
view of a person standing 15 m
(50 ft.) away from the camera.

Unique user interface allows for quick navigation over a wide area

In Normal mode, AXIS P5544 uses the zoom lens when panning, tilting and zooming, just like any other PTZ camera. The 18x optical zoom with autofocus in HDTV 720p ensures outstanding video quality. The camera can be steered with both a joystick and a mouse.

The user interface in Normal mode features in the right-hand corner a snapshot of the 360° field of view. The Overview snapshot is a static shot—not a live view.

The Overview snapshot functions conveniently as a map of the monitored area. It helps to orient the user to where the camera is pointing at all times (as indicated with a green circle). In addition, the user can click on a spot in the Overview snapshot to quickly steer the zoom lens to a different location and, thereby, monitor a new area in Normal mode.

If PTZ preset positions are defined, the presets show up as small circles in the Overview snapshot. Clicking on a preset circle in the Overview snapshot or clicking on a preset button in the bottom row of the interface will steer the camera view to the pre-defined position.

As with other PTZ cameras, the view can also be adjusted (re-centered) by clicking in the live view. Zoom can be made by using the joystick, the Zoom bar in the interface, using Area zoom or by rotating the mouse wheel.

Going back to Overview mode can be done by clicking in the center of the Overview snapshot or clicking on the Overview button (located in the top menu row at far left of the interface).

The unique interface gives the operator many ways to quickly get to an area of interest, enabling efficient monitoring of a wide area.

Technical specifications – AXIS P5544 PTZ Dome Network Camera

Camera		Network	
Models	AXIS P5544 60 Hz; AXIS P5544 50 Hz	Security	Password protection, IP address filtering, HTTPS* encryption, IEEE 802.1X* network access control, digest authentication, user access log
Image sensor	1/3" progressive scan CCD 1.3 megapixel	Supported protocols	IPv4/v6, HTTP, HTTPS*, SSL/TLS*, QoS Layer 3 DiffServ, FTP, SMB, SMTP, Bonjour, UPnP™, SNMPv1/v2c/v3 (MIB-II), DNS, DynDNS, NTP, RTSP, RTP, TCP, UDP, IGMP, RTCP, ICMP, DHCP, ARP, SOCKS
Zoom lens for use in Normal mode	f=4.7 – 84.6 mm, F1.6 – 2.8, autofocus, automatic day/night Horizontal angle of view: 55.2° – 3.2°	System integration	
Panopsis lens for use in Overview mode	f=2.7 mm Angle of view: 180°	Application Programming Interface	Open API for software integration, including VAPIX® and AXIS Camera Application Platform from Axis Communications, available at www.axis.com ONVIF, specification available at www.onvif.org AXIS Video Hosting System (AVHS) with One-Click Camera Connection
Minimum illumination	Color: 0.74 lux at 30 IRE F1.6 B/W: 0.04 lux at 30 IRE F1.6	Intelligent video	Audio detection, Advanced Gatekeeper Support for AXIS Camera Application Platform enabling installation of additional applications Overview mode: Video motion detection
Shutter time	1/10 000 s to 1/4 s	Event triggers	Video motion detection, audio detection, external input, PTZ preset, temperature, memory card full, AXIS Camera Application Platform
Pan/tilt/zoom	E-flip, Auto-flip, 100 preset positions Pan: 360° (with Auto-flip), 0.2° – 300°/s Tilt: 180°, 0.2° – 300°/s 18x optical zoom and 12x digital zoom, total 216x zoom	Event actions	File upload via FTP, HTTP and email Notification via email, HTTP and TCP External output, PTZ preset, video recording to edge storage, play audio clip Pre- and post-alarm video buffering
Pan/tilt/zoom functionalities	Limited guard tour Control queue On-screen directional indicator	Installation aid	Pixel counter
Video		General	
Video compression	H.264 (MPEG-4 Part 10/AVC) Motion JPEG	Casing	IP51-rated, metal casing (aluminum), acrylic (PMMA) clear dome
Resolutions	HDTV 720p 1280x720 to 320x180	Processors and memory	ARTPEC-3, 256 MB RAM, 128 MB Flash
Frame rate	H.264: Up to 30/25 fps (60/50 Hz) in all resolutions Motion JPEG: Up to 30/25 fps (60/50 Hz) in all resolutions	Power	Power over Ethernet Plus (PoE+) IEEE 802.3at, max. 30 W 20–24 V AC, max. 23.6 VA 24–34 V DC, max. 17 W AXIS T8123 High PoE Midspan 1-port: 100–240 V AC, max. 37 W
Video streaming	Multiple, individually configurable streams in H.264 and Motion JPEG Controllable frame rate and bandwidth VBR/CBR H.264	Connectors	RJ-45 for 10BASE-T/100BASE-TX PoE Multi-connector (cable sold separately) for power in, 4 configurable alarm inputs/outputs, mic in, line mono input, line mono output to active speaker
Image settings	Wide dynamic range (WDR), manual shutter time, compression, color, brightness, sharpness, white balance, exposure control, exposure zones, backlight compensation, fine tuning of behavior at low light, text overlay, image freeze on PTZ Normal mode: Image overlay, 3D privacy mask	Edge storage	SD/SDHC memory card slot (card not included) Support for recording to network share (network-attached storage or file server)
Audio		Operating conditions	0 °C to 50 °C (32 °F to 122 °F) Humidity 20 – 80% RH (non-condensing)
Audio streaming	Two-way	Approvals	EN 55022 Class B, EN 61000-3-2, EN 61000-3-3, EN 61000-6-1, EN 61000-6-2, EN 55024, FCC Part 15 Subpart B Class B, ICES-003 Class B, VCCI Class B, C-tick AS/NZS CISPR 22, EN 60950-1, KCC Class B, IEC 60721-4-3 Class 3K3, 3M3, EN/IEC 60068-2 IEC 60529 IP51 Midspan: EN 60950-1, GS, UL, cUL, CE, VCCI, CB, KCC
Audio compression	AAC-LC 8/16 kHz, G.711 PCM 8 kHz, G.726 ADPCM 8 kHz Configurable bit rate	Weight	Camera: 1.9 kg (4.2 lb.) Camera with drop-ceiling mount: 2.3 kg (5.1 lb.)
Input/output	Requires multi-connector cable (sold separately) for external microphone input or line input and line output	Included accessories	AXIS T8123 High PoE Midspan 1-port, mounting kit for hard and drop ceilings, Installation Guide, Installation and Management Software CD, Windows decoder 1-user license

Dimensions

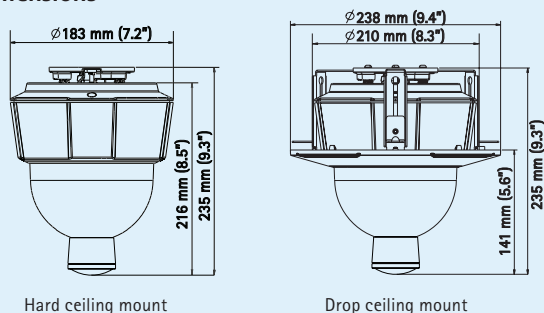

* This product includes software developed by the OpenSSL Project for use in the OpenSSL Toolkit. (www.openssl.org)

More information is available at www.axis.com