



General Specifications

Motor Protection:

Locker Rotor, Reverse Polarity

Insulation Resistance:

100M Ω or over with a DC500V Megger

Dielectric Withstand Voltage: AC 700V 1s

Allowable Ambient Temperature Range:

-30°C ~ +70°C (Operating)

-40°C ~ +70°C (Storage)

Expected Life

Failure Rate: 10%

40°C 70,000 Hours

Outline

Units: $\frac{\text{inch}}{\text{mm}}$

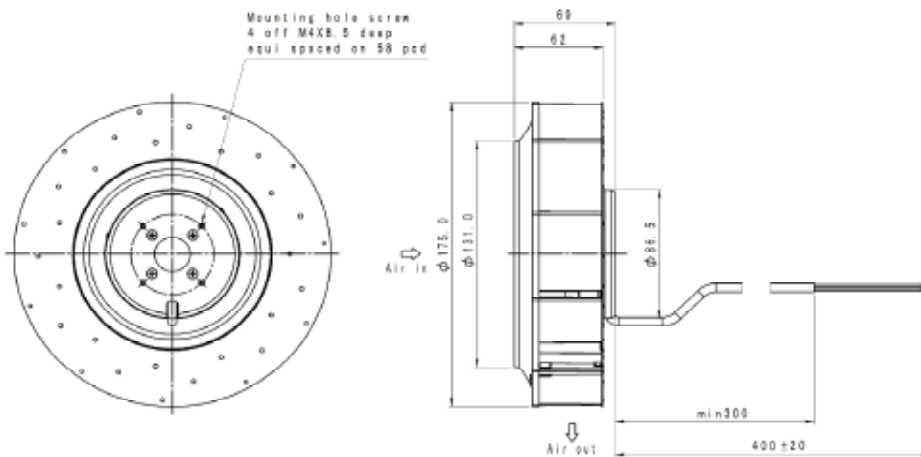

Characteristic Curves

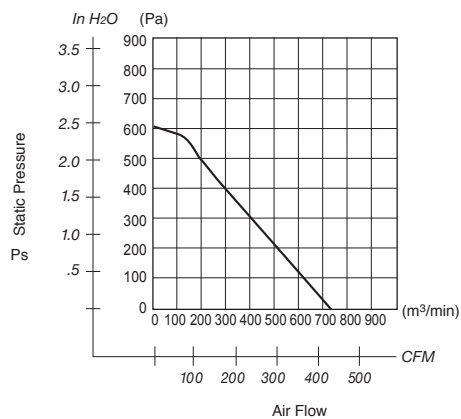

Material

Impeller : Plastic

Bearing : Ball Bearings

Specifications

MODEL	Product No.	Rated Voltage	Operating Voltage	Current	Input Power	Speed	Max. Air Flow		Max. Static Pressure		Noise	Mass
		(V)	(V)	(A) ^{*1}	(W) ^{*1}	(min ⁻¹) ^{*1}	CFM ^{*1}	(m ³ /H)	in H ₂ O	(Pa) ^{*1}	(dB) ^{*1}	(g)
175R069-DO5	AXX	24	16 ~ 28	4.3	103	4400	432.6	735	2.4	604	73.0	-
175R069-DO7	AXX	48	36 ~ 57	2.0	96	4400	432.6	735	2.4	604	73.0	-

*1: Average Values in Free Air