



General Specifications

Motor Protection:

Auto Restart/Polarity Protection

Insulation Resistance: 10M Ω or over with a DC500V Megger

Dielectric Withstand Voltage: AC 700V 1s

Allowable Ambient Temperature Range:

- B80: -10°C ~ +60°C (Operating)
- B70: -10°C ~ +70°C (Operating)
- B50 ~ B60: -10°C ~ +50°C (Operating)
- B10 ~ B40: -10°C ~ +70°C (Operating)
- All Class: -40°C ~ +70°C (Storage)
(non-condensing environment)

Characteristic Curves

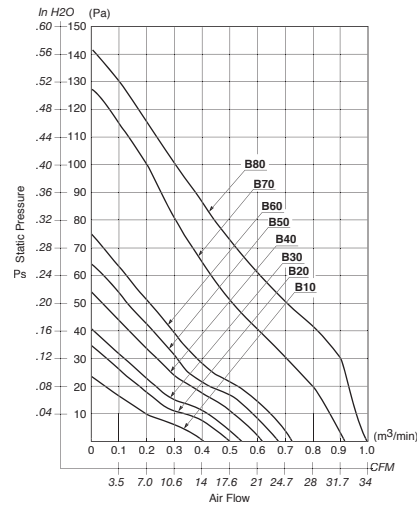

Outline

Units: $\frac{\text{inch}}{\text{mm}}$

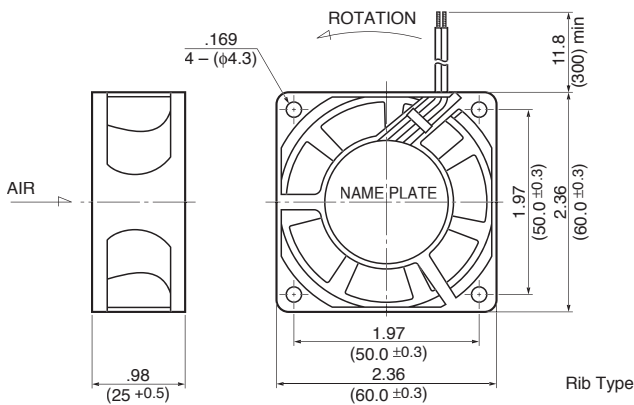

Panel Cut-outs

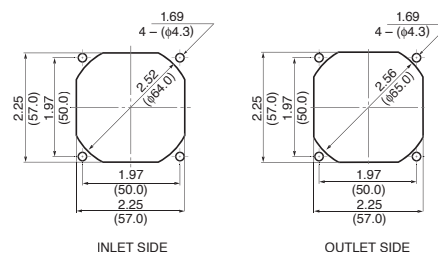

Material

- Casing : Plastic (Black) 94V-0
- Impeller : Plastic (Black) 94V-0
- Bearing : Ball Bearing
- Lead Wire : UL1007, AWG24, +Red, -Black

Specifications

MODEL	Product No.	Rated Voltage	Operating Voltage	Current (A) ^{*1}	Input Power (W) ^{*1}	Speed (min ⁻¹) ^{*1}	Max. Air Flow		Max. Static Pressure		Noise (dB) ^{*1}	Mass (g)
		(V)	(V)				CFM ^{*1}	(m ³ /min) ^{*1}	in H ₂ O	(Pa) ^{*1}		
2410ML-04W-B10-	X00	12	6.0 ~ 13.8	0.07	0.90	2950	13.7	0.39	.08	20.6	23.0	65
2410ML-04W-B20-	X00	12	6.0 ~ 13.8	0.12	1.44	3600	16.9	0.48	.13	31.9	28.0	65
2410ML-04W-B30-	X00	12	6.0 ~ 13.8	0.12	1.44	4000	19.0	0.54	.16	40.2	31.0	65
2410ML-04W-B40-	X00	12	6.0 ~ 13.8	0.17	2.04	4550	21.5	0.61	.20	51.9	33.5	65
2410ML-04W-B50-	X00	12	6.0 ~ 13.8	0.20	2.40	4900	23.3	0.66	.25	62.2	35.0	65
2410ML-04W-B60-	X00	12	6.0 ~ 13.8	0.30	3.60	5300	25.0	0.71	.29	73.0	36.0	65
2410ML-04W-B70-	X00	12	6.0 ~ 13.8	0.44	5.28	6800	33.1	0.94	.50	125	45.0	65
2410ML-04W-B80-	X00	12	6.0 ~ 13.2	0.52	6.20	7800	37.0	1.05	.57	142.5	46.0	65
2410ML-05W-B10-	X00	24	10.0 ~ 27.6	0.06	1.44	2950	13.7	0.39	.08	20.6	23.0	65
2410ML-05W-B20-	X00	24	10.0 ~ 27.6	0.07	1.68	3600	16.9	0.48	.13	31.9	28.0	65
2410ML-05W-B30-	X00	24	10.0 ~ 27.6	0.06	1.44	4000	19.0	0.54	.16	40.2	31.0	65
2410ML-05W-B40-	X00	24	10.0 ~ 27.6	0.09	2.16	4550	21.5	0.61	.20	51.9	33.5	65
2410ML-05W-B50	X00	24	10.0 ~ 27.6	0.10	2.40	4900	23.3	0.66	.25	62.2	35.0	65
2410ML-05W-B60-	X00	24	10.0 ~ 27.6	0.13	3.12	5300	25.0	0.71	.29	73.0	36.0	65
2410ML-05W-B70-	X00	24	10.0 ~ 25.2	0.19	4.56	6800	33.1	0.94	.50	125	45.0	65

Rotation: Counterclockwise

Airflow Outlet: Air Out Over Struts

*1: Average Values in Free Air