



CX1HSM CRYSTAL

10 kHz to 600 kHz

Miniature Surface Mount
Quartz Crystal for Series Oscillators

DESCRIPTION

The CX1HSM quartz crystal is a high quality tuning fork resonator for use in Series (two cascaded inverters) oscillators. The CX1HSM is hermetically sealed in a rugged, miniature ceramic package. The CX1HSM crystal is manufactured using the STATEK-developed photolithographic process, and was designed utilizing the experience acquired by producing millions of crystals for industrial, commercial, military and medical applications. Maximum process temperature should not exceed 260°C.

FEATURES

- Miniature tuning fork design
- High shock resistance
- Designed for low power applications
- Compatible with hybrid or PC board packaging
- Low aging
- Full military testing available
- Designed and manufactured in the USA

EQUIVALENT CIRCUIT

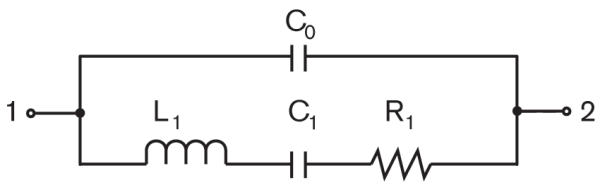

R_1 Motional Resistance L_1 Motional Inductance
 C_1 Motional Capacitance C_0 Shunt Capacitance

SUGGESTED LAND PATTERN

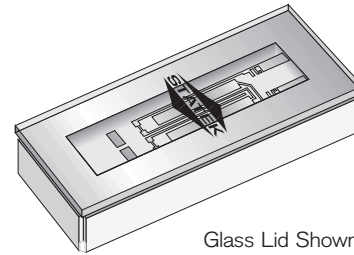
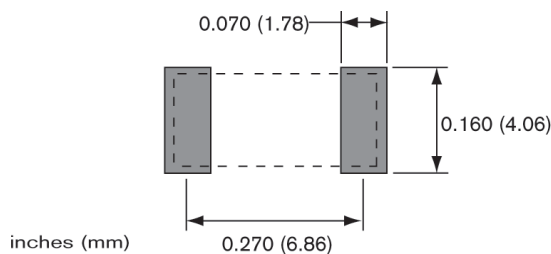

Glass Lid Shown

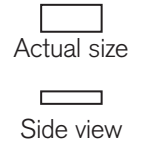

PACKAGE DIMENSIONS

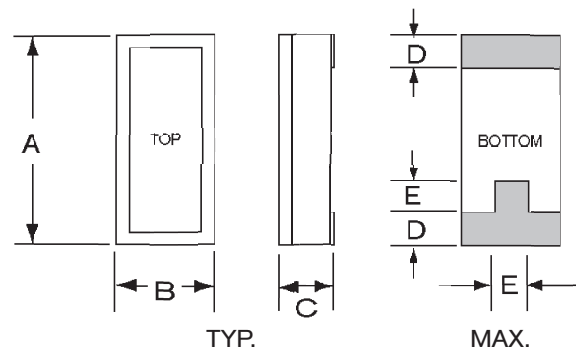

DIM	TYP.		MAX.	
	inches	mm	inches	mm
A	0.315	8.00	0.330	8.38
B	0.140	3.56	0.155	3.94
C	-	-	see below	
D	0.045	1.14	0.055	1.40
E	0.060	1.52	0.070	1.78

DIM "C"	GLASS LID		CERAMIC LID	
	inches	mm	inches	mm
MAX				
SM1	0.065	1.65	0.070	1.78
SM2/SM4	0.067	1.70	0.072	1.83
SM3/SM5	0.070	1.78	0.075	1.90

CONVENTIONAL SERIES OSCILLATOR CIRCUIT

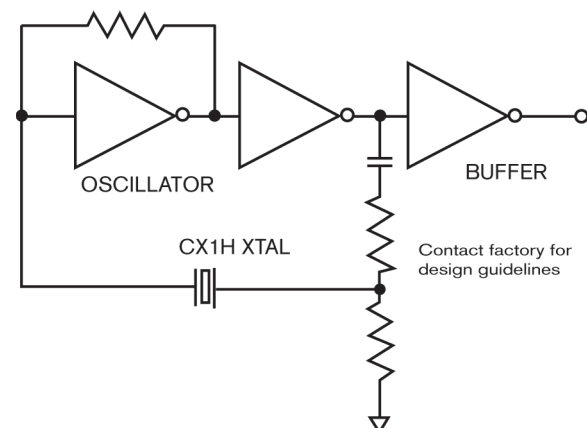

10122 - Rev E



SPECIFICATIONS

Specifications are typical at 25°C unless otherwise noted.
Specifications are subject to change without notice.

Frequency Range 10 kHz to 600 kHz

Standard Calibration Tolerance¹ (see table below)

Motional Resistance (R_1) Figure 1
MAX.: 10-169.9 kHz, 2x Typ.
170-600 kHz, 2.5x Typ.

Motional Capacitance (C_1) Figure 2

Quality Factor (Q) Figure 3
Min. is 0.25x Typ.

Shunt Capacitance (C_0) 2.0 pF MAX

Drive Level 10-24.9 kHz 1.5 μ W MAX
25-600 kHz 3.0 μ W MAX

Turning Point (T_0)² Figure 4

Temperature Coefficient (k) -0.035 ppm/°C²

Aging, first year 5 ppm MAX

Shock, survival³ 1,000 g, 1ms, 1/2 sine

Vibration, survival³ 20 g RMS, 10-2,000 Hz

Operating Temp. Range -10°C to +70°C (Commercial)
-40°C to +85°C (Industrial)
-55°C to +125°C (Military)

Storage Temp. Range -55°C to +125°C

Max Process Temperature 260°C for 20 sec.

1. Tighter frequency calibration available.

2. Other turning point available.

3. Higher shock and vibration available.

CX1HSM Standard Calibration Tolerance at 25°C

Frequency Range (kHz)			
10-74.9	75-169.9	170-249.9	250-600
± 30 ppm (0.003%)	± 50 ppm (0.005%)	± 100 ppm (0.01%)	±200 ppm (0.02%)
± 100 ppm (0.01%)	± 100 ppm (0.01%)	± 200 ppm (0.02%)	±500 ppm (0.05%)
± 1000 ppm (0.1%)	± 1000 ppm (0.1%)	± 2000 ppm (0.2%)	±5000 ppm (0.5%)

HOW TO ORDER CX1HSM CRYSTALS

CX1H	S	C	SM1 - 32.768K	, 30	/ I
"S" if special or custom design. Blank if Std.			Frequency K = kHz	Calibration Tolerance @ 25°C (in ppm)	Operating Temp. Range: C = -10°C to +70°C I = -40°C to +85°C M = -55°C to +125°C S = Customer Specified
Blank = Glass Lid C = Ceramic Lid			SM1 = Gold Plated (Lead Free) SM2 = Solder Plated SM3 = Solder Dipped SM4 = Solder Plated (Lead Free) SM5 = Solder Dipped (Lead Free)		

TERMINATIONS

Designation	Termination
SM1	Gold Plated (Lead Free)
SM2	Solder Plated
SM3	Solder Dipped
SM4	Solder Plated (Lead Free)
SM5	Solder Dipped (Lead Free)

FIGURE 1
CX1H TYPICAL MOTIONAL RESISTANCE (R_1)

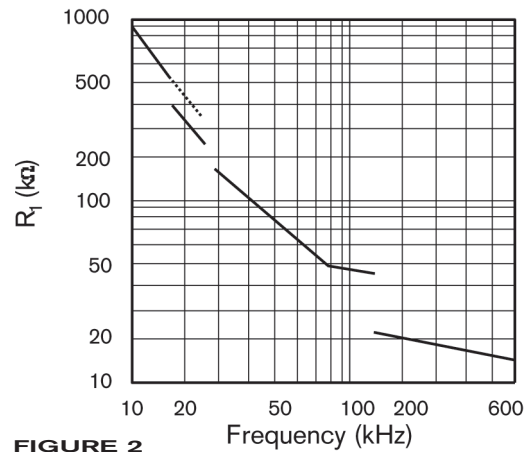

FIGURE 2
CX1H TYPICAL MOTIONAL CAPACITANCE (C_1)

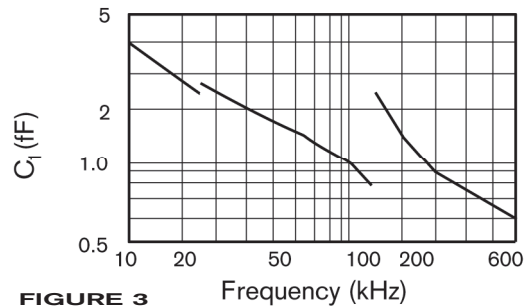

FIGURE 3
CX1H TYPICAL QUALITY FACTOR (Q)

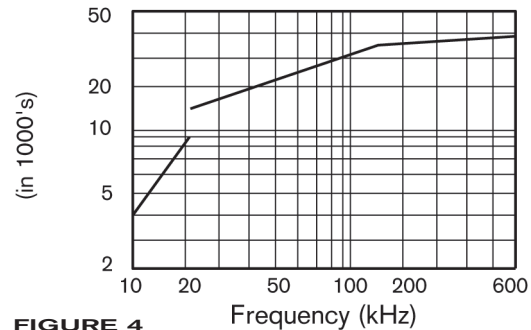
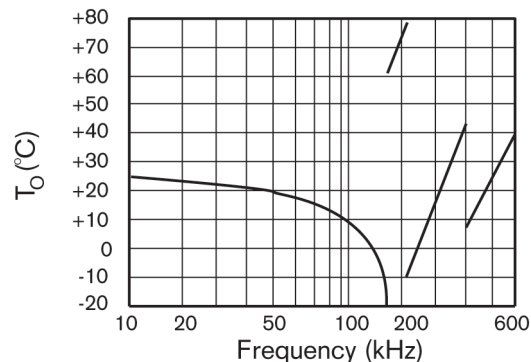

FIGURE 4
CX1H TYPICAL TURNING POINT TEMP. (T_0)



Note: Frequency f at temperature T is related to frequency f_0 at turning point temperature T_0 by:
$$\frac{f-f_0}{f_0} = k(T-T_0)^2$$

PACKAGING

CX1HSM - Tray Pack
- 16mm tape, 7" or 13" reels
(Reference tape and reel data sheet 10109)