

UNCONTROLLED DOCUMENT

PART NUMBER		REV.
SSL-LXA228UPGCTR31		A
REV.	E.C.N. NUMBER AND REVISION COMMENTS	DATE
A	E.C.N. #11148	11.15.06

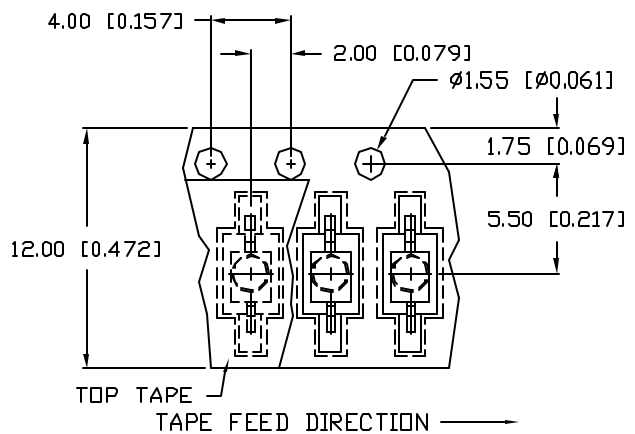

RECOMMENDED SOLDER PAD LAYOUT

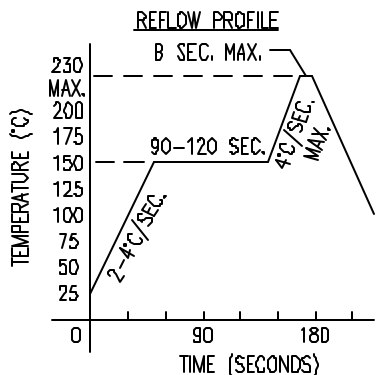
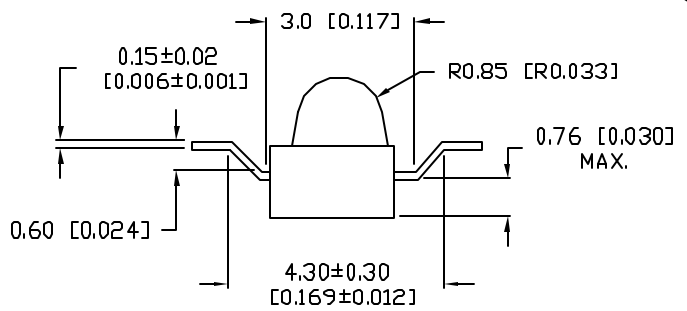
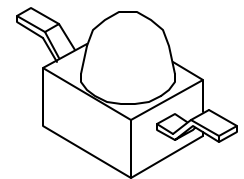
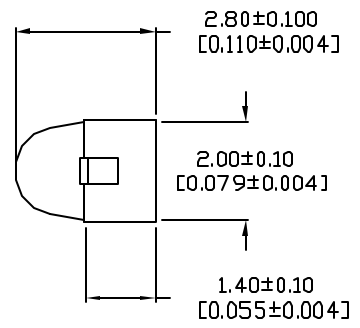
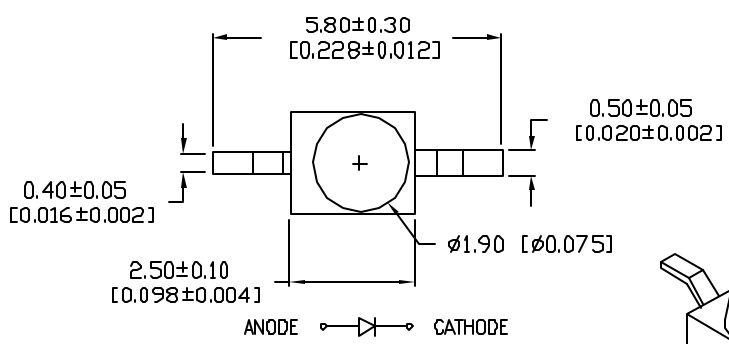
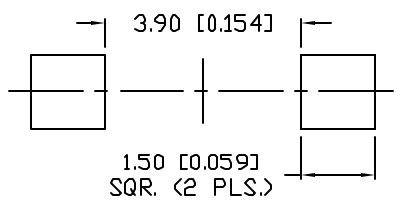

ELECTRO-OPTICAL CHARACTERISTICS $T_A=25^\circ\text{C}$ $I_f=20\text{mA}$

PARAMETER	MIN	TYP	MAX	UNITS	TEST COND
PEAK WAVELENGTH		525		nm	
FORWARD VOLTAGE		3.5	4.0	V_f	
REVERSE VOLTAGE	5.0			V_r	$I_f=100\mu\text{A}$
AXIAL INTENSITY		1400		mcd	$I_f=20\text{mA}$
VIEWING ANGLE		30		2x theta	
EMITTED COLOR:	GREEN				
EPOXY LENS FINISH:	WATER CLEAR				

LIMITS OF SAFE OPERATION AT 25°C

PARAMETER	MAX	UNITS
PEAK FORWARD CURRENT*	100	mA
STEADY CURRENT	30	mA
POWER DISSIPATION	120	mW
DERATE FROM 25°C	-1.2	mW/°C
OPERATING TEMP.	-40 TO +85	°C
STORAGE TEMP.	-40 TO +85	°C

* $t < 10\mu\text{s}$

NOTES:

- 1,000 PIECES PER REEL.
- THE CATHODE IS ORIENTED TOWARDS THE TAPE SPROCKET HOLE.

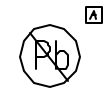

CAUTION: STATIC SENSITIVE DEVICE
FOLLOW PROPER E.S.D. HANDLING PROCEDURES
WHEN WORKING WITH THIS PART.

UNCONTROLLED DOCUMENT

*UNLESS OTHERWISE SPECIFIED TOLERANCES PER DECIMAL PRECISION ARE: X=±1 (±0.038), XX=±0.5 (±0.020), XXX=±0.25 (±0.010), XXXX=±0.127 (±0.005). LEAD SIZE=±0.05 (±0.002), LEAD LENGTH=±0.75 (±0.030), MIN=+DECIMAL PRECISION MAX.=+0.00 -DECIMAL PRECISION

REV.	PART NUMBER
A	SSL-LXA228UPGCTR31

CONFIDENTIAL INFORMATION
THE INFORMATION CONTAINED IN THIS DOCUMENT IS THE PROPERTY OF LUMEX INC. EXCEPT AS SPECIFICALLY AUTHORIZED IN WRITING BY LUMEX INC, THE HOLDER OF THIS DOCUMENT SHALL KEEP ALL INFORMATION CONTAINED HEREIN CONFIDENTIAL AND SHALL PROTECT SAME IN WHOLE OR IN PART FROM DISCLOSURE AND DISSEMINATION TO ALL THIRD PARTIES.



290 E. HELEN ROAD
PALATINE, IL 60067-6976
PHONE: +1.847.359.2790
US WEB: www.lumex.com
TW WEB: www.lumex.com.tw

525nm ULTRA PURE GREEN, AXIAL LED,
WATER CLEAR LENS, Z BEND, TAPE AND REEL.

RELIABILITY NOTE
OUR MANY YEARS OF EXPERIENCE DATA ACCUMULATION INDICATE THAT SOLDER HEAT IS A MAJOR CAUSE OF EARLY AND FUTURE FAILURE. PLEASE PAY ATTENTION TO YOUR SOLDERING PROCESS.

DRAWN BY:	CHECKED BY:	APPROVED BY:	DATE: 11.15.06
JC			PAGE: 1 OF 1
			SCALE: N/A