

# SML0805-881-TR

880nm Infrared  
0805 Profile Surface Mount LEDs  
2.0×1.25×1.0mm  
120° viewing angle

DWG BY:  
BL / JG  
12-11-06

CHK BY:  
\_\_\_\_\_  
\_\_\_\_\_-06

QA:  
\_\_\_\_\_  
\_\_\_\_\_-\_\_\_\_

MFG:  
\_\_\_\_\_  
\_\_\_\_\_-\_\_\_\_

REVISION LTR: -  
12-11-06

## Features:

1. Lens Appearance: Water Clear.
2. 2.0x1.25x1.0mm (0805) standard package.
3. Suitable for all SMT assembly methods.
4. Compatible with infrared and vapor phase reflow solder process.
5. Compatible with automatic placement equipment.

## Applications:

- Remote Control.
- Smoke Detector
- Photo Detector
- Automatic Control System

## Package Dimensions:

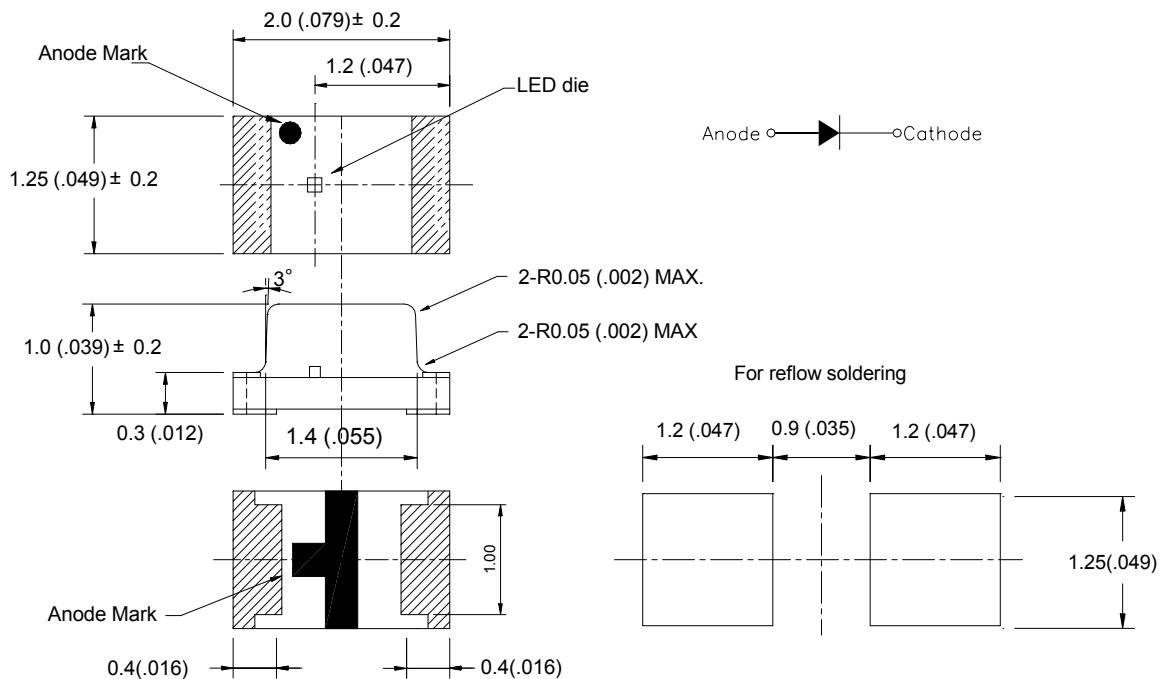

Part No.	Chip Material	Lens Color	Emission Color
SML0805-881-TR	GaAIAs/GaAs	Water Clear	Infrared

### Notes:

1. All dimensions are in millimeters (inches).
2. Tolerance is ±0.10mm (0.004") unless otherwise specified.
3. Specifications are subject to change without notice.

● **Electrical and optical characteristics (Ta=25°C)**

Parameter	Symbol	Condition	Min.	Typ.	Max.	Unit
Forward Voltage	V <sub>F</sub>	I <sub>F</sub> =50mA	-	1.6	2.2	V
Peak Wave Length	λ <sub>p</sub>	I <sub>F</sub> =50mA	-	880	-	nm
Spectral Line Half-width	Δλ	I <sub>F</sub> =50mA	-	70	-	nm
Viewing Angle*	2θ <sub>1/2</sub>	I <sub>F</sub> =50mA	-	120	-	deg
Radiant Intensity	I <sub>e</sub>	I <sub>F</sub> =50mA	0.92	2	-	μW/sr
Rise/Fall Time	T <sub>r</sub>	I <sub>FP</sub> =20mA PW=10μS DC=1%	-	500	-	ns
	T <sub>f</sub>		-	200	-	

\* Viewing angle is the Off-axis at which the luminous intensity is half the axial intensity.

● **Absolute Maximum Ratings (Ta=25°C)**

Reverse Voltage	V <sub>R</sub>	5V
Reverse Current (VR=5V)	I <sub>R</sub>	50μA
Continuous Forward Current	I <sub>f</sub>	50mA
Peak Forward Current 1 Pulse Width = 10μs, 1% Duty Cycle	I <sub>fp</sub>	500mA
Power Dissipation	P <sub>d</sub>	100mW
Operating Temperature Range	T <sub>opr</sub>	-25°C ~ 80°C
Storage Temperature Range	T <sub>stg</sub>	-30°C ~ 85°C
Lead Soldering Temperature	T <sub>sol</sub>	see Solder Instruction page

● **Typical Electro-Optical Characteristics Curves**

Fig.1 Relative spectral sensitivity vs wavelength

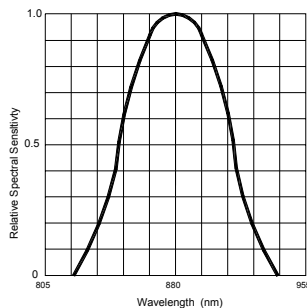

Fig.2 Total power dissipation vs ambient temperature

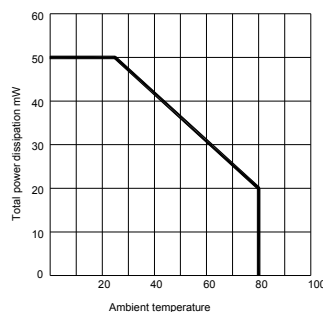

Fig.3 Forward current vs forward voltage

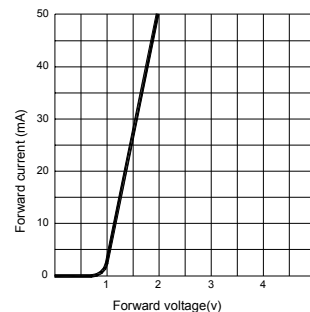

Fig.4 RELATIVE LUMINOUS INTENSITY VS. AMBIENT TEMPERATURE

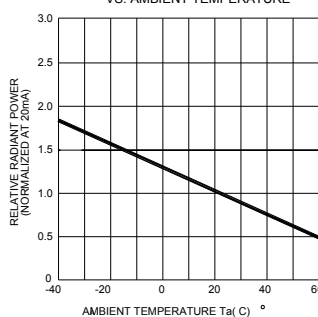

Fig.5 Relative luminous intensity vs forward current

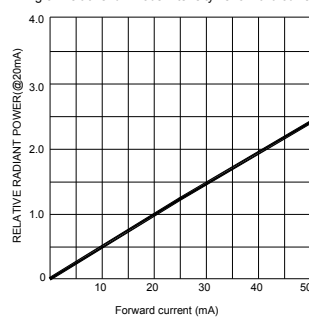
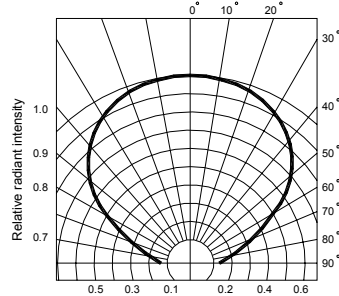
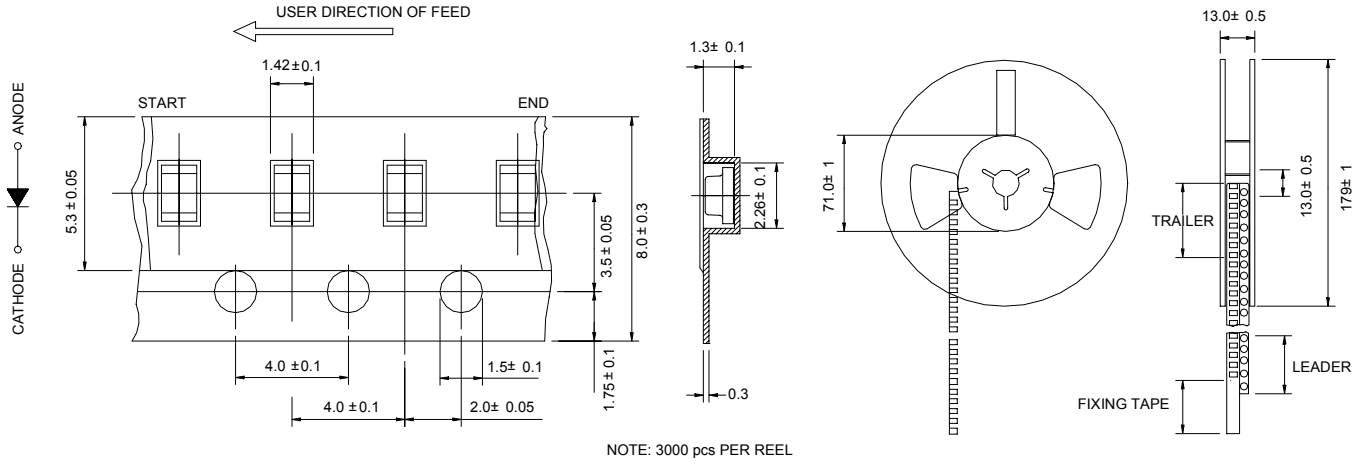

Fig.6 Radiation diagram



● **Tape and reel packaging specifications (Units: mm)**



● **Bin Limits**

Intensity Bin Limits (At 50mA)

BIN CODE	Min. (mcd)	Max. (mcd)
4	0.92	1.30
5	1.30	1.83
6	1.83	2.57
7	2.57	3.60

Tolerance for each Bin limit is ± 15%

● **BIN : x**

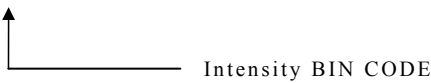

**RELIABILITY TEST**

Classification	Test Item	Reference Standard	Test Conditions	Result
Endurance Test	Operation Life	MIL-STD-750: 1026 MIL-STD-883: 1005 JIS C 7021: B-1	Connect with a power I = 20mA T <sub>a</sub> = Under room temperature Test time = 1,000hrs	0/20
	High Temperature, High Humidity Storage	MIL-STD-202: 103B JIS C 7021: B-11	T <sub>a</sub> = +65°C±5°C RH = 90%-95% Test time = 240hrs	0/20
	High Temperature Storage	MIL-STD-202: 1008 JIS C 7021: B-10	High T <sub>a</sub> = +85°C±5°C Test time = 1,000hrs	0/20
	Low Temperature Storage	JIS C 7021: B-12	Low T <sub>a</sub> = -35°C±5°C Test time = 1,000hrs	0/20
Environmental Test	Temperature Cycling	MIL-STD-202: 107D MIL-STD-750: 1051 MIL-STD-883: 1010 JIS C 7021: A-4	-35°C ~ +25°C ~ +85°C ~ +25°C 60min. 20min. 60min. 20min. Test time = 5 cycles	0/20
	Thermal Shock	MIL-STD-202: 107D MIL-STD-750: 1051 MIL-STD-883: 1011	-35°C±5°C ~ +85°C±5°C 20min. 20min. Test time = 10 cycles	0/20
	Solder Resistance	MIL-STD-202: 201A MIL-STD-750: 2031 JIS C 7021: A-1	Preheating: 140°C - 160°C, within 2 minutes. Operation heating: 260°C (Max.), within 10 seconds. (Max.)	0/20

**JUDGEMENT CRITERIA OF FAILURE FOR THE RELIABILITY TEST**

Measuring items	Symbol	Measuring conditions	Judgment criteria for failure
Collector Dark Current	I <sub>d</sub>	V <sub>CE</sub> = 20V, H=1.0 mW/cm <sup>2</sup>	Over Ux2
Collector Light Current	I <sub>SC</sub>	V <sub>CE</sub> = 5V, H=1.0 mW/cm <sup>2</sup>	Below SX0.5

Note: 1. U means the upper limit of specific characteristics. S means initial value.  
 2. Measurement shall be taken between 2 hours and after the test pieces have been returned to normal ambient conditions after completion of each test.

**1. Soldering**  
**Manual of Soldering**

The temperature of the iron tip should not be higher than 300°C (572°F) and soldering within 3 seconds per solder-land is to be observed.

**Reflow Soldering**  
 Preheating: 140°C~160°C ±5°C, within 2 minutes.  
 Operation heating: 260°C (Max.) within 10 seconds. (Max.)  
 Gradual Cooling (Avoid quenching).

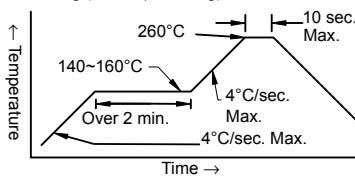

**DIP Soldering (Wave Soldering)**  
 Preheating: 120°C~150°C, within 120~180 sec.  
 Operation heating: 245°C ±5°C within 5 sec.  
 260°C (Max.)  
 Gradual Cooling (Avoid quenching).

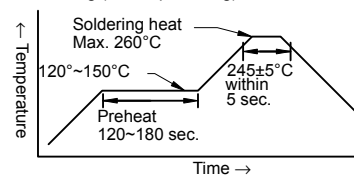

**2. Handling**

Care must be taken not to cause damage to the epoxy resin portion of LEDs while it is exposed to high temperatures, or abrade the epoxy resin portion of LEDs with hard or sharp items as from sand blasting and the use of sharp metallic objects.

**3. Notes for designing**

Care must be taken to provide the current limiting resistor in the circuit so as to drive the LEDs within the rated figures. Also, caution should be taken not to overload LEDs with instantaneous voltage at the turning ON and OFF of the circuit. When using the pulse drive care must be taken to keep the average current within the rated figures. Also, the circuit should be designed so as to be subjected to reverse voltage when turning off the LEDs.

**4. Storage:**

In order to avoid the absorption of moisture, it is recommended to solder LEDs as soon as possible after unpacking the sealed envelope. If the envelope is still packed, store it in the following environment:

- (1) Temperature: 5°C-30°C (41°F-86°F) Humidity: RH 60% Max.
- (2) After this bag is opened, devices that will be applied to infrared reflow, vapor-phase reflow, or equivalent soldering process must be:
  - a. Completed within 24 hours.
  - b. Stored at less than 30% RH
- (3) Devices require baking before mounting if: (2)a or (2)b is not met.
- (4) If baking is required, devices must be baked under below conditions:  
 12 hours at 60°C ±3°C