

KM4110/KM4120

0.5mA, Low Cost, +2.7V & +5V, 75MHz Rail-to-Rail Amplifiers

Features

- 505 μ A supply current
- 75MHz bandwidth
- Power down to $I_s = 33\mu$ A (KM4120)
- Fully specified at +2.7V and +5V supplies
- Output voltage range: 0.07V to 4.86V; $V_s = +5$
- Input voltage range: -0.3V to +3.8V; $V_s = +5$
- 50V/ μ s slew rate
- ± 15 mA linear output current
- ± 30 mA output short circuit current
- 12nV/ $\sqrt{\text{Hz}}$ input voltage noise
- Directly replaces AD8031 in single supply applications
- Small package options (SOT23-5 and SOT23-6)

Applications

- Portable/battery-powered applications
- A/D buffer
- Active filters
- Signal conditioning
- Portable test instruments

KM4110/KM4120 Packages

SOT23-5 (KM4110)

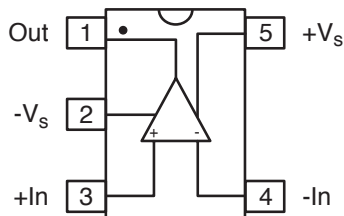

SOT23-6 (KM4120)

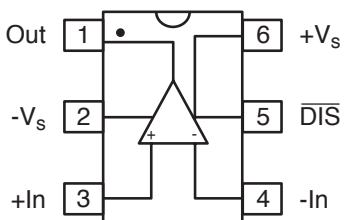

General Description

The KM4110 (single) and KM4120 (single with disable) are low cost, voltage feedback amplifiers. These amplifiers are designed to operate on +2.7V, +5V, or ± 2.5 V supplies. The input voltage range extends 300mV below the negative rail and 1.2V below the positive rail.

The KM4110 offers superior dynamic performance with a 75MHz small signal bandwidth and 50V/ μ s slew rate. The combination of low power, high output current drive, and rail-to-rail performance make the KM4110 well suited for battery-powered communication/ computing systems.

The combination of low cost and high performance make the KM4110 suitable for high volume applications in both consumer and industrial applications such as wireless phones, scanners, and color copiers.

The KM4210 dual op amp is also available.

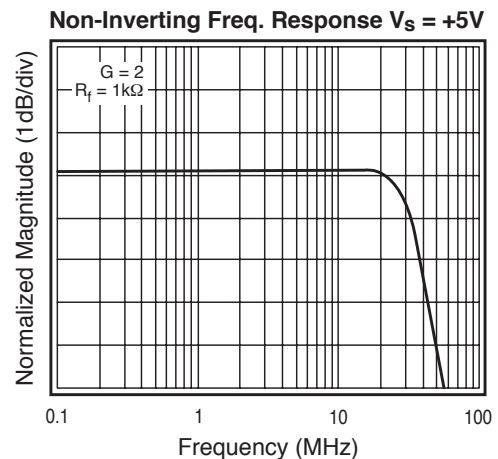

KM4110/KM4120 Electrical Characteristics ($V_s = +2.7V$, $G = 2$, $R_L = 1k\Omega$ to $V_s/2$, $R_f = 1k\Omega$; unless noted)

Parameters	Conditions	TYP	Min & Max	UNITS	NOTES
Case Temperature		+25°C	+25°C		
Frequency Domain Response					
-3dB bandwidth	$G = +1$, $V_O = 0.05V_{pp}$	65		MHz	1
full power bandwidth	$G = +2$, $V_O < 0.2V_{pp}$	30		MHz	
gain bandwidth product	$G = +2$, $V_O = 2V_{pp}$	12		MHz	
		28		MHz	
Time Domain Response					
rise and fall time	0.2V step	7.5		ns	
settling time to 0.1%	1V step	60		ns	
overshoot	1V step,	10		%	
slew rate	2V step, $G = -1$	40		V/ μ s	
Distortion and Noise Response					
2nd harmonic distortion	$1V_{pp}$, 1MHz	67		dBc	
3rd harmonic distortion	$1V_{pp}$, 1MHz	72		dBc	
THD	$1V_{pp}$, 1MHz	65		dB	
input voltage noise	>10kHz	12		nV/ \sqrt{Hz}	
DC Performance					
input offset voltage		0	± 5	mV	2
average drift		10		μ V/ $^{\circ}$ C	
input bias current		1.2	± 3.5	μ A	2
average drift		3.5		nA/ $^{\circ}$ C	
input offset current		30	350	nA	2
power supply rejection ratio	DC	66	60	dB	2
open loop gain		98	65	dB	2
quiescent current		470	600	μ A	2
Disable Characteristics					
turn on time		0.54		μ s	
turn off time		4.3		μ s	
off isolation	5MHz, $R_L = 100\Omega$	58		dB	
quiescent current		15		μ A	
Input Characteristics					
input resistance		9		M Ω	
input capacitance		1.5		pF	
input common mode voltage range		-0.3 to 1.5		V	
common mode rejection ratio	DC, $V_{cm} = 0V$ to $V_s - 1.5$	98	78	dB	2
Output Characteristics					
output voltage swing	$R_L = 10k\Omega$ to $V_s/2$	0.05 to 2.6	0.2 to 2.35	V	2
linear output current	$R_L = 1k\Omega$ to $V_s/2$	0.09 to 2.53		V	
short circuit output current		± 15		mA	
power supply operating range		± 25	2.5 to 5.5	mA	
		2.7		V	

Min/max ratings are based on product characterization and simulation. Individual parameters are tested as noted. Outgoing quality levels are determined from tested parameters.

NOTES:

- 1) For $G = +1$, $R_f = 0$.
- 2) 100% tested at +25°C.

Absolute Maximum Ratings

supply voltage	0 to +6V
maximum junction temperature	+175°C
storage temperature range	-65°C to +150°C
lead temperature (10 sec)	+260°C
operating temperature range (recommended)	-40°C to +85°C
input voltage range	+ V_s +0.5V; - V_s -0.5V
internal power dissipation	see power derating curves

Package Thermal Resistance

Package	θ_{JA}
5 lead SOT23	256°C/W
6 lead SOT23	230°C/W

KM4110/KM4120 Electrical Characteristics ($V_s = +5V$, $G = 2$, $R_L = 1k\Omega$ to $V_s/2$, $R_f = 1k\Omega$; unless noted)

PARAMETERS	CONDITIONS	TYP	MIN & MAX	UNITS	NOTES
Case Temperature		+25°C	+25°C		
Frequency Domain Response					
-3dB bandwidth	$G = +1$, $V_O = 0.05V_{pp}$	75		MHz	1
full power bandwidth	$G = +2$, $V_O < 0.2V_{pp}$	35		MHz	
gain bandwidth product	$G = +2$, $V_O = 2V_{pp}$	15		MHz	
		33		MHz	
Time Domain Response					
rise and fall time	0.2V step	6		ns	
settling time to 0.1%	2V step	60		ns	
overshoot	2V step,	12		%	
slew rate	2V step, $G = -1$	50		V/ μ s	
Distortion and Noise Response					
2nd harmonic distortion	$2V_{pp}$, 1MHz	64		dBc	
3rd harmonic distortion	$2V_{pp}$, 1MHz	62		dBc	
THD	$2V_{pp}$, 1MHz	60		dB	
input voltage noise	>10kHz	12		nV/ \sqrt{Hz}	
DC Performance					
input offset voltage		-1	± 5	mV	2
average drift		10		μ V/ $^{\circ}C$	
input bias current		1.2	± 3.5	μ A	2
average drift		3.5		nA/ $^{\circ}C$	
input offset current		30	350	nA	2
power supply rejection ratio	DC	65	60	dB	2
open loop gain		80	65	dB	2
quiescent current		505	620	μ A	2
Disable Characteristics					
turn on time		0.33		μ s	
turn off time		5.5		μ s	
off isolation	5MHz, $R_L = 100\Omega$	58		dB	
quiescent current		33		μ A	
Input Characteristics					
input resistance		9		M Ω	2
input capacitance		1.5		pF	
input common mode voltage range		-0.3 to 3.8		V	
common mode rejection ratio	DC, $V_{cm} = 0V$ to $V_s - 1.5$	92	78	dB	
Output Characteristics					
output voltage swing	$R_L = 10k\Omega$ to $V_s/2$	0.08 to 4.84	0.2 to 4.65	V	2
	$R_L = 1k\Omega$ to $V_s/2$	0.13 to 4.73		V	
linear output current		± 15		mA	
short circuit output current		± 30		mA	
power supply operating range		5	2.5 to 5.5	V	

Min/max ratings are based on product characterization and simulation. Individual parameters are tested as noted. Outgoing quality levels are determined from tested parameters.

NOTES:

- 1) For $G = +1$, $R_f = 0$.
- 2) 100% tested at +25°C.

KM4110/KM4120 Performance Characteristics ($V_s = +5V$, $G = 2$, $R_L = 1k\Omega$ to $V_s/2$, $R_f = 1k\Omega$; unless noted)

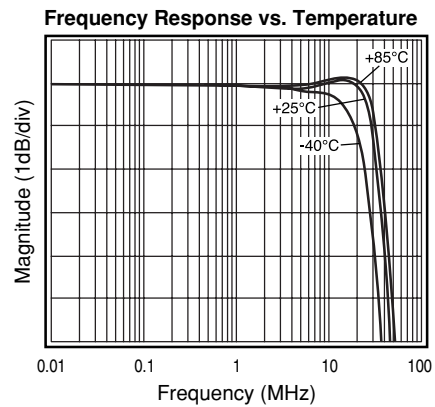
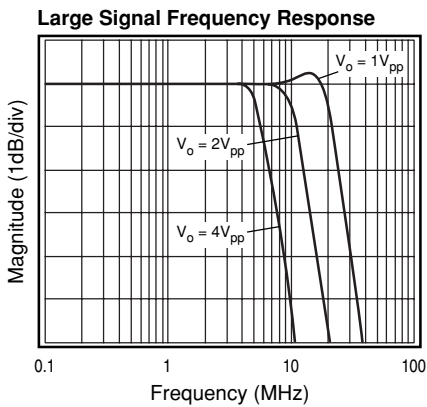
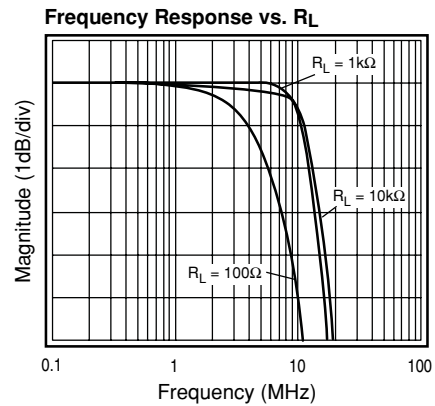
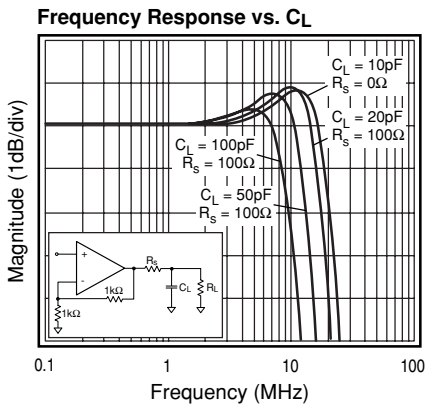
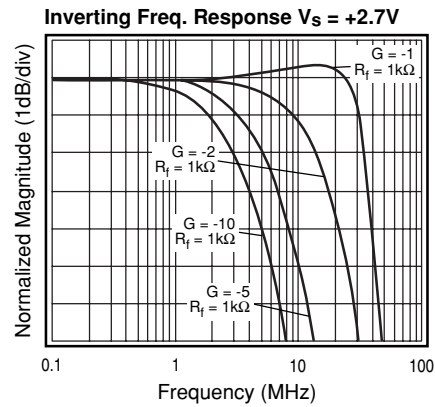
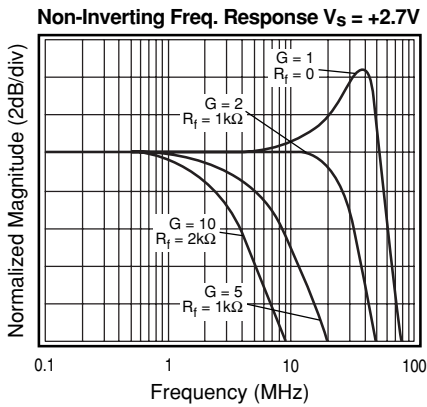
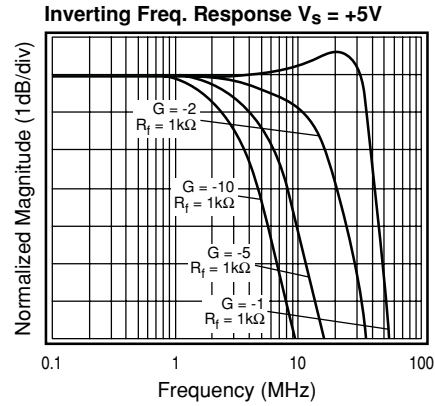
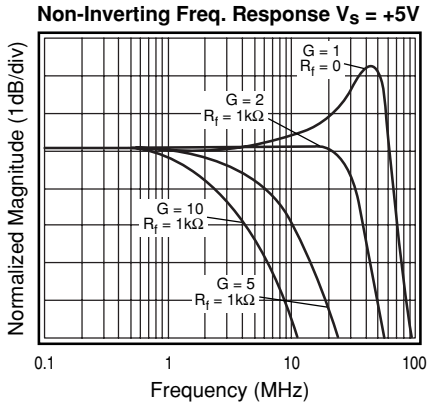

KM4110/KM4120 Performance Characteristics ($V_s = +5V$, $G = 2$, $R_L = 1k\Omega$ to $V_s/2$, $R_f = 1k\Omega$; unless noted)

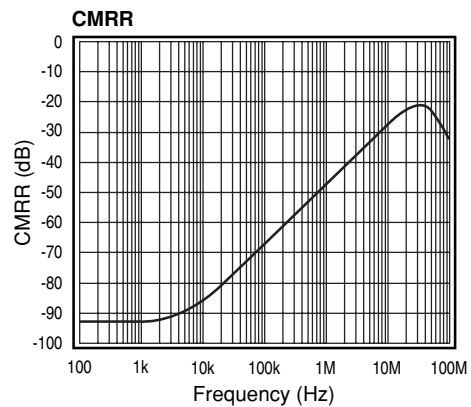
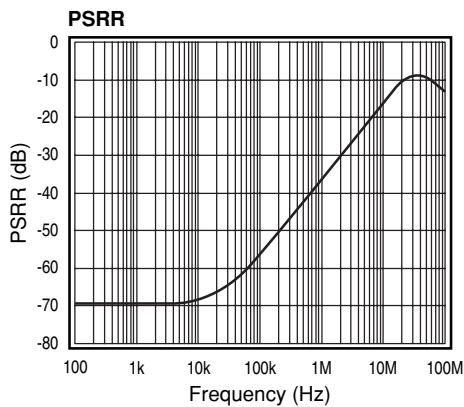
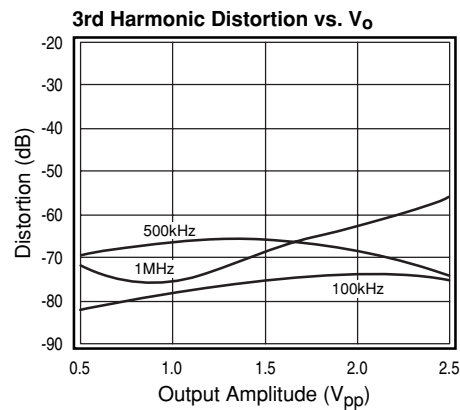
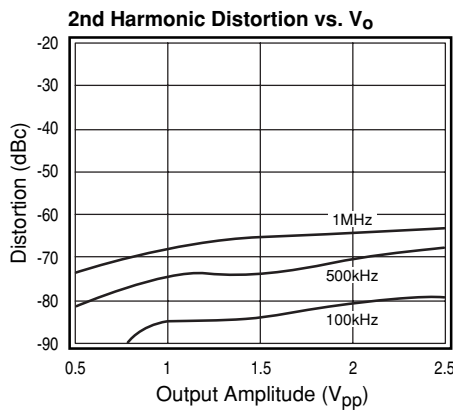
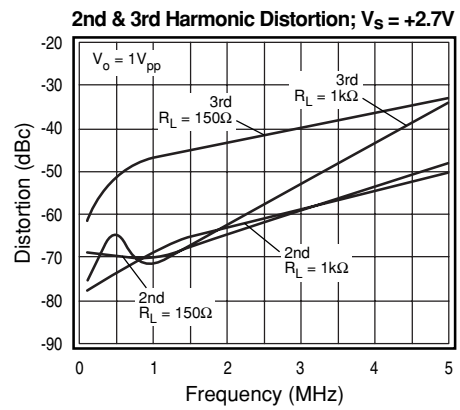
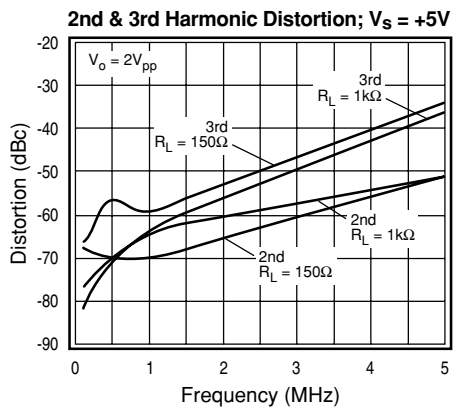
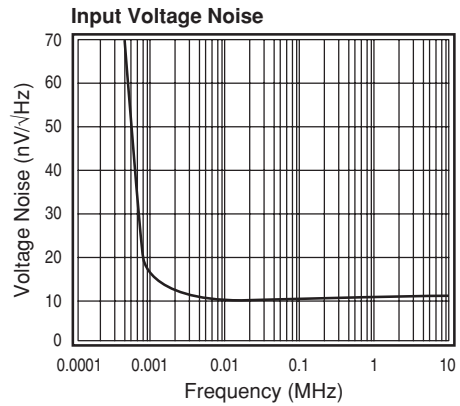
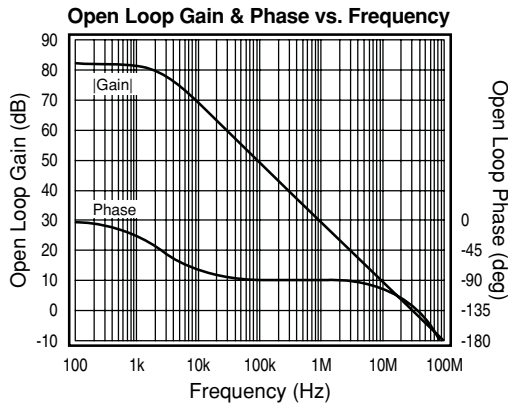

KM4110/KM4120 Performance Characteristics ($V_S = +5V$, $G = 2$, $R_L = 1k\Omega$ to $V_S/2$, $R_f = 1k\Omega$; unless noted)

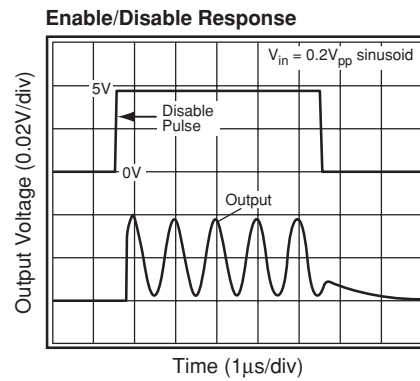
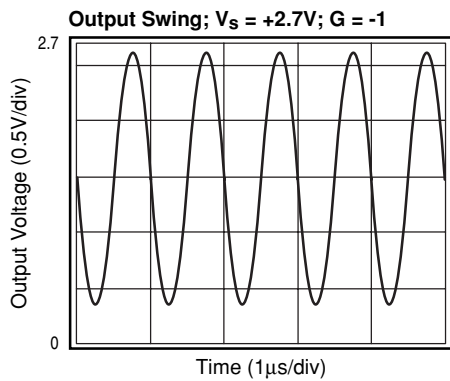
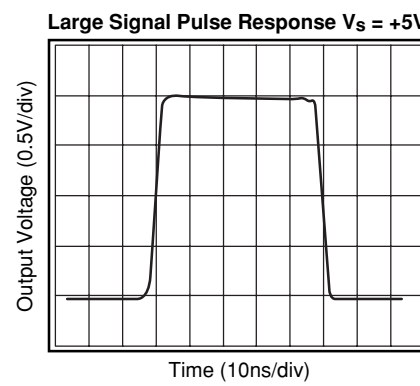
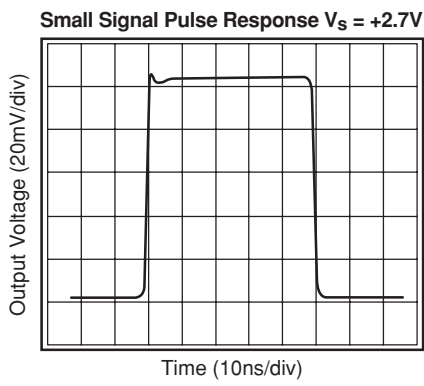
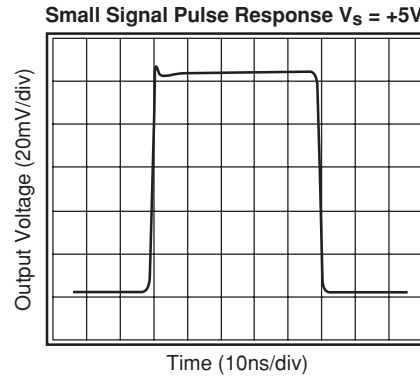
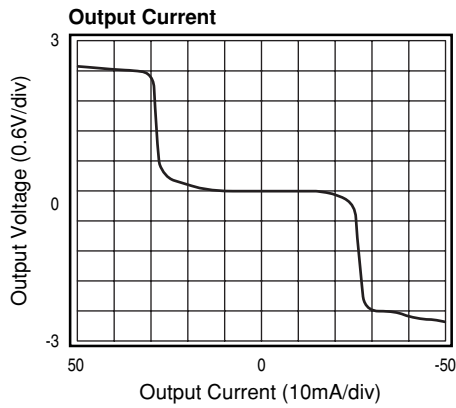

General Description

The KM4110 is a single supply, general purpose, voltage-feedback amplifier fabricated on a complementary bipolar process. The KM4110 offers 75MHz unity gain bandwidth, 50V/ μ s slew rate, and only 505 μ A supply current. It features a rail-to-rail output stage and is unity gain stable.

The design utilizes a patent pending topology that provides increased slew rate performance. The common mode input range extends to 300mV below ground and to 1.2V below V_S . Exceeding these values will not cause phase reversal. However, if the input voltage exceeds the rails by more than 0.5V, the input ESD devices will begin to conduct. The output will stay at the rail during this overdrive condition.

The design uses a Darlington output stage. The output stage is short circuit protected and offers "soft" saturation protection that improves recovery time.

The typical circuit schematic is shown in Figure 1.

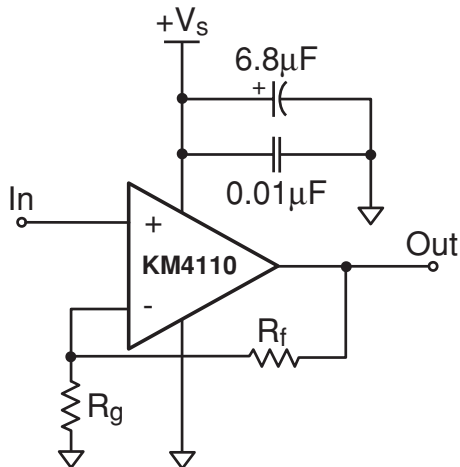

Figure 1: Typical Configuration

For optimum response at a gain of +2, a feedback resistor of 1k Ω is recommended. Figure 2 illustrates the KM4110 frequency response with both 1k Ω and 2k Ω feedback resistors.

Enable/Disable Function (KM4120)

The KM4120 offers an active-low disable pin that can be used to lower its supply current. Leave the pin floating to enable the part. Pull the disable pin to the negative supply (which is ground in a single supply application) to disable the output. During the disable condition, the nominal supply current will drop to below 30 μ A and the output will be at high impedance with about 2pF capacitance.

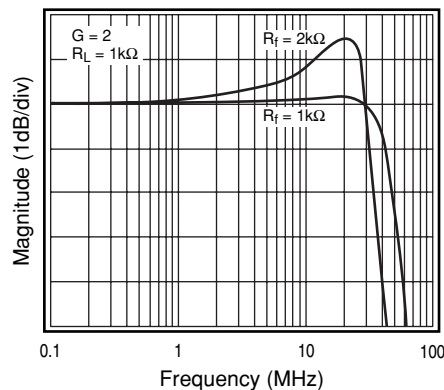

Figure 2: Frequency Response vs. R_f

Power Dissipation

The maximum internal power dissipation allowed is directly related to the maximum junction temperature. If the maximum junction temperature exceeds 150 $^{\circ}$ C, some reliability degradation will occur. If the maximum junction temperature exceeds 175 $^{\circ}$ C for an extended time, device failure may occur.

The KM4110 is short circuit protected. However, this may not guarantee that the maximum junction temperature (+150 $^{\circ}$ C) is not exceeded under all conditions. Follow the maximum power derating curves shown in Figure 3 to ensure proper operation.

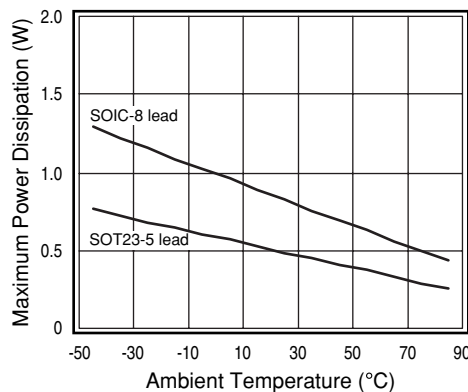

Figure 3: Power Derating Curves

Overdrive Recovery

For an amplifier, an overdrive condition occurs when the output and/or input ranges are exceeded. The recovery time varies based on whether the input or output is overdriven and by how much the ranges are exceeded. The KM4110 will typically recover in less than 20ns from an overdrive condition. Figure 4 shows the KM4110 in an overdriven condition.

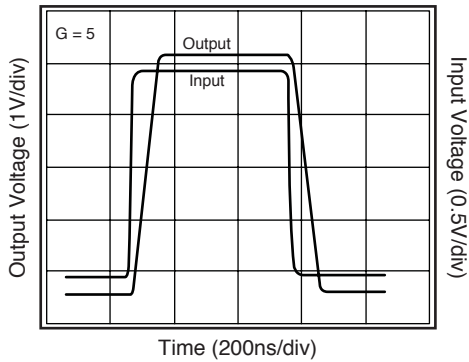

Figure 4: Overdrive Recovery

Driving Capacitive Loads

The Frequency Response vs. C_L plot on page 4, illustrates the response of the KM4110 and KM4120. A small series resistance (R_s) at the output of the amplifier, illustrated in Figure 5, will improve stability and settling performance. R_s values in the Frequency Response vs. C_L plot were chosen to achieve maximum bandwidth with less than 1dB of peaking. For maximum flatness, use a larger R_s .

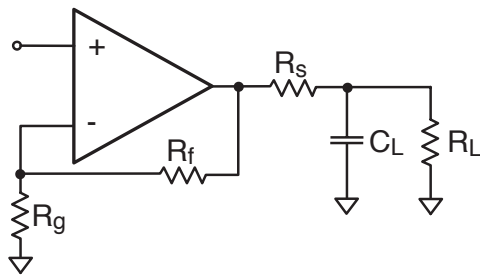

Figure 5: Typical Topology for driving a capacitive load

Layout Considerations

General layout and supply bypassing play major roles in high frequency performance. CADEKA has evaluation boards to use as a guide for high frequency layout and to aid in device testing and characterization. Follow the steps below as a basis for high frequency layout:

- Include 6.8 μ F and 0.01 μ F ceramic capacitors
- Place the 6.8 μ F capacitor within 0.75 inches of the power pin
- Place the 0.01 μ F capacitor within 0.1 inches of the power pin
- Remove the ground plane under and around the part, especially near the input and output pins to reduce parasitic capacitance
- Minimize all trace lengths to reduce series inductances

Refer to the evaluation board layouts shown in Figure 7 for more information.

Evaluation Board Information

The following evaluation boards are available to aid in the testing and layout of this device:

Eval Board	Description	Products
KEB002	Single Channel, Dual Supply 5 & 6 lead SOT23	KM4110IT5, KM4120IT6

Evaluation board schematics and layouts are shown in Figure 6 and Figure 7.

The KEB002 evaluation board is built for dual supply operation. Follow these steps to use the board in a single supply application:

1. Short $-V_s$ to ground
2. Use C3 and C4, if the $-V_s$ pin of the KM4110 or KM4120 is not directly connected to the ground plane.

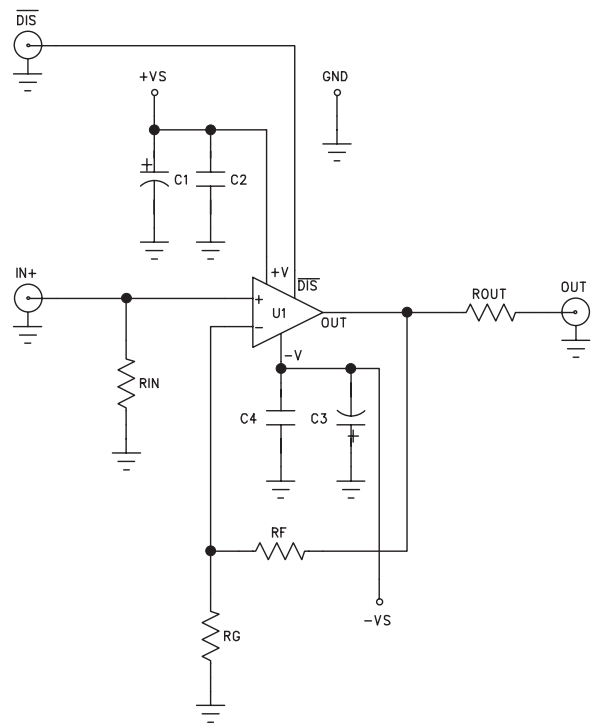

Figure 6: Evaluation Board Schematic

KM4110/KM4120 Evaluation Board Layout

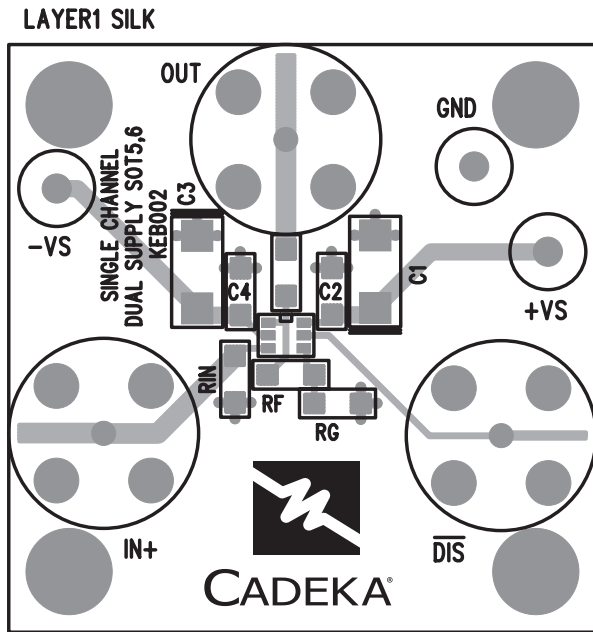

Figure 7a: KEB002 (top side)

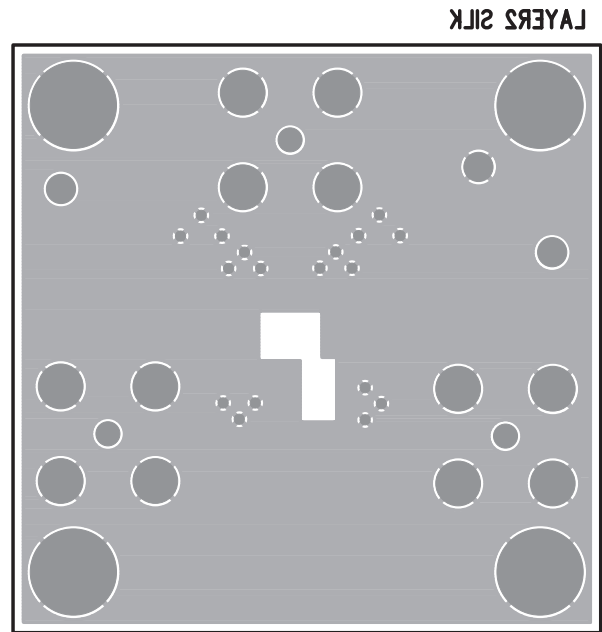
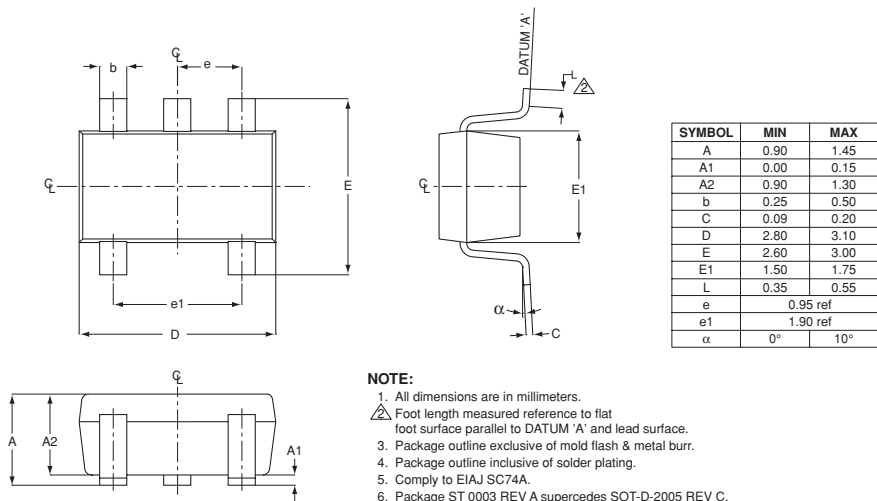

Figure 7b: KEB002 (bottom side)

KM4110/KM4120 Package Dimensions

SOT23-5



SOT23-6

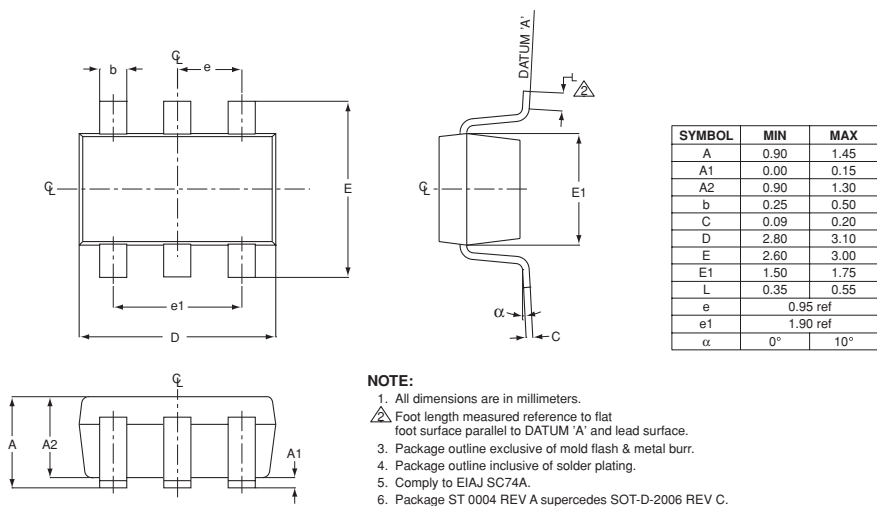

Ordering Information

Model	Part Number	Package	Container	Pack Qty
KM4110	KM4110IT5	SOT23-5	Partial Rail	<3000
KM4110	KM4110IT5TR3	SOT23-5	Reel	3000
KM4120	KM4120IT6	SOT23-6	Partial Rail	<3000
KM4120	KM4120IT6TR3	SOT23-6	Reel	3000

Temperature range for all parts: -40°C to +85°C

For additional information regarding our products, please visit the CADEKA at: cadeka.com

CADEKA Headquarters Loveland, Colorado

T: 970.663.5452

T: 877.663.5452 (toll free)

CADEKA, the CADEKA logo design, and COMLINEAR and the COMLINEAR logo design, are trademarks or registered trademarks of CADEKA Microcircuits LLC. All other brand and product names may be trademarks of their respective companies.

CADEKA reserves the right to make changes to any products and services herein at any time without notice. CADEKA does not assume any responsibility or liability arising out of the application or use of any product or service described herein, except as expressly agreed to in writing by CADEKA; nor does the purchase, lease, or use of a product or service from CADEKA convey a license under any patent rights, copyrights, trademark rights, or any other of the intellectual property rights of CADEKA or of third parties.

Copyright ©2001 by CADEKA Microcircuits LLC. All rights reserved.

