

COMLINEAR® CLCUSB30

Low Power, High-Speed (480MSPS) USB 2.0 Analog Switch

COMLINEAR CLCUSB30 Low Power, High-Speed (480MSPS) USB 2.0 Analog Switch REV 0.1.4

FEATURES

- ±8kV ESD protection on all pins
- 7pF on capacitance
- 4.0Ω on resistance
- 720MHz -3dB bandwidth
- <1μA supply current in standby mode
- <6μA over a wide control voltage range
- -45dB crosstalk
- Power-off protection when $V_S = 0V$; D+ and D- tolerate up to 5.25V
- Power-on protection when $V_S \neq 0V$; D+ and D- tolerate up to 5.25V
- Input voltage range extends 0.3V beyond V_S
- Operates from 3V to 4.3V supplies
- Pb-free MSOP-10 package

APPLICATIONS

- Cell phones
- PDAs
- Digital cameras
- Notebooks
- LCD TVs
- Set top box
- High-speed differential signal applications
- USB 2.0 switching

General Description

The CLCUSB30 is a dual-pole, double-throw (DPDT) analog switch designed for switching high-speed analog signals. The CLCUSB30 is optimized for switching 480Mbps (USB2.0) signals in portable devices such as cell phones, digital cameras, PDAs, and notebook computers.

The CLCUSB30 offers superior crosstalk (-45dB) and off-isolation (-30dB) to reduce channel-to-channel interference and provide good signal integrity. The low on-channel resistance and capacitance reduce attenuation and distortion during bi-directional HS signal routing.

The CLCUSB30 also features protection circuitry on D+ and D- pins that allows the switch to handle overvoltage conditions when powered on or off.

Functional Block Diagram

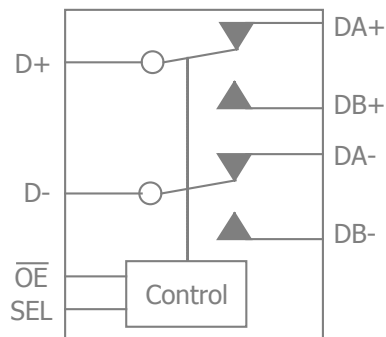

Typical Application

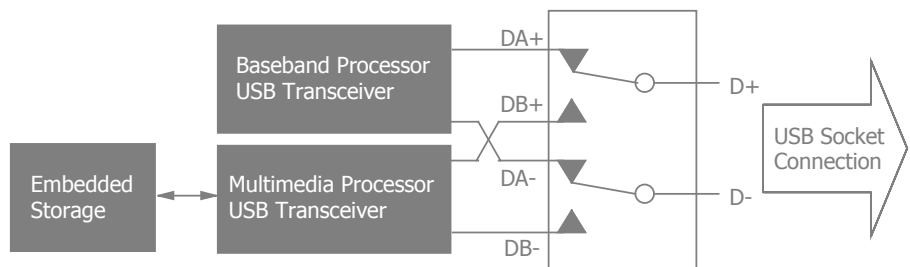

Ordering Information

Part Number	Package	Pb-Free	RoHS Compliant	Operating Temperature Range	Packaging Method
CLCUSB30IMP10X*	MSOP-10	Yes	Yes	-40°C to +125°C	Reel

*Preliminary, contact CADEKA for availability. Moisture sensitivity level for all parts is MSL-1.



Pin Configuration

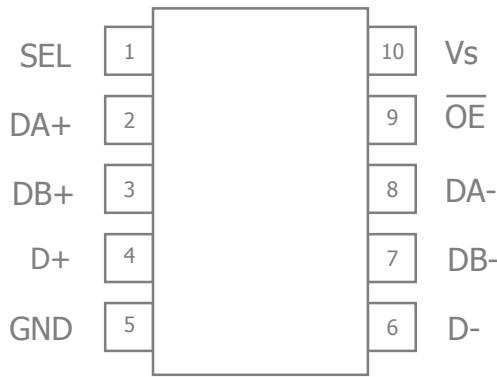

Pin Assignments

Pin No.	Pin Name	Description
1	SEL	Select Input
2	DA+	A Data Port
3	DB+	B Data Port
4	D+	Common Data Port
5	GND	Ground
6	D-	Common Data Port
7	DB-	B Data Port
8	DA-	A Data Port
9	\overline{OE}	Output Enable Bar
10	V _S	Positive supply

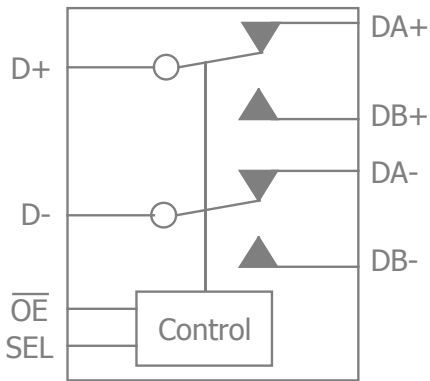

Truth Table

SEL	\overline{OE}	Function
X	HIGH	Disconnect
LOW	LOW	Select A Port; (D+, D- = DA+, DA-)
HIGH	LOW	Select B Port; (D+, D- = DB+, DB-)

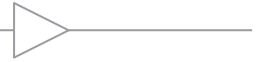

Absolute Maximum Ratings

The safety of the device is not guaranteed when it is operated above the "Absolute Maximum Ratings". The device should not be operated at these "absolute" limits. Adhere to the "Recommended Operating Conditions" for proper device function. The information contained in the Electrical Characteristics tables and Typical Performance plots reflect the operating conditions noted on the tables and plots.

Parameter	Min	Max	Unit
Supply Voltage	-0.5	4.6	V
SEL Voltage	-0.5	4.6	V
Input Voltage Range (DA/B+, DA/B-)	0.5	+V _S +0.3V	V
Input Voltage Range (D+, D- when V _S > 0)	0.5	+V _S +0.3V	V
Input Voltage Range (D+, D- when V _S = 0)	-0.5	5.25	V
Input / Output Current		50	mA

Reliability Information

Parameter	Min	Typ	Max	Unit
Junction Temperature			150	°C
Storage Temperature Range	-65		150	°C
Lead Temperature (Soldering, 10s)			260	°C
Package Thermal Resistance				
10-Lead MSOP		130		°C/W

Notes:

Package thermal resistance (θ_{JA}), JEDEC standard, multi-layer test boards, still air.

ESD Protection

Product	MSOP-10
Human Body Model (HBM)	8kV
Charged Device Model (CDM)	2kV
Charged Device Model (MM)	400V

Recommended Operating Conditions

Parameter	Min	Typ	Max	Unit
Operating Temperature Range	-40		+125	°C
Supply Voltage Range	3		4.3	V
SEL Voltage Range	0		V _S	V
Input Voltage Range (D+, D-, DA/B+, DA/B-)	0		V _S	V



Electrical Characteristics

$T_A = 25^\circ\text{C}$, $V_S = +3\text{V}$; unless otherwise noted.

Symbol	Parameter	Conditions	Min	Typ	Max	Units
Frequency Domain Response						
$BW_{-3\text{dB}}$	-3dB Bandwidth	$R_L = R_S = 50\Omega$, $C_L = 0\text{pF}$		720		MHz
		$R_L = R_S = 50\Omega$, $C_L = 5\text{pF}$		550		MHz
Time Domain Response						
t_{ON}	Turn-On Time	$V_{\text{IN/OUT}} = 0.8\text{V}$, $R_L = 50\Omega$, $C_L = 5\text{pF}$, $V_{\text{SEL_HIGH}} = V_S$, $V_{\text{SEL_LOW}} = 0$, $3 \leq V_S \leq 3.6\text{V}$		13		ns
t_{OFF}	Turn-Off Time	$V_{\text{IN/OUT}} = 0.8\text{V}$, $R_L = 50\Omega$, $C_L = 5\text{pF}$, $V_{\text{SEL_HIGH}} = V_S$, $V_{\text{SEL_LOW}} = 0$, $3 \leq V_S \leq 3.6\text{V}$		12		ns
$t_{\text{PD_RISE/FALL}}$	Rise/Fall Propagation Delay	$R_L = R_S = 50\Omega$, $C_L = 5\text{pF}$, $V_S = 3.3\text{V}$		0.25		ns
t_{BBM}	Break-Before-Make Delay Time	$R_L = R_S = 50\Omega$, $C_L = 5\text{pF}$, $3 \leq V_S \leq 3.6\text{V}$		5		ns
t_{SK1}	Output Skew Between Switches	Skew between Switch 1 and Switch 2, $R_L = 50\Omega$, $C_L = 5\text{pF}$, $3 \leq V_S \leq 3.6\text{V}$		0.05		ns
t_{SK2}	Output Skew of Same Switches	Skew between opposite transitions in same switch, $R_L = 50\Omega$, $C_L = 5\text{pF}$, $3 \leq V_S \leq 3.6\text{V}$		0.02		ns
Distortion/Noise Response						
OFF_{ISO}	Off Isolation	$f = 240\text{MHz}$, $R_L = R_S = 50\Omega$, $C_L = 0\text{pF}$, $V_S = 3\text{V}$		-30		dB
X_{TALK}	Crosstalk	Channel-to-channel at $f = 240\text{MHz}$, $R_L = R_S = 50\Omega$, $C_L = 0\text{pF}$, $V_S = 3\text{V}$		-45		dB
DC Performance						
$V_{\text{SEL_HIGH}}$	Control Input High Voltage	$3 \leq V_S \leq 3.6\text{V}$	1.3			V
		$V_S = 4.3\text{V}$	1.7			V
$V_{\text{SEL_LOW}}$	Control Input Low Voltage	$3 \leq V_S \leq 3.6\text{V}$			0.5	V
		$V_S = 4.3\text{V}$			0.7	V
I_{SEL}	Control Input Leakage Current	$0 \leq V_{\text{SEL}} \leq V_S$, $V_S = 4.3\text{V}$	-1		1	μA
I_S	Quiescent Supply Current	$V_{\text{SEL}} = 0\text{V}$ or V_S , $I_{\text{IN/OUT}} = 0\text{A}$			1	μA
I_{ST}	Increase in I_S on V_S pin per Control Voltage	$V_{\text{SEL}} = 2.6\text{V}$, $V_S = 4.3\text{V}$			10	μA
		$V_{\text{SEL}} = 1.8\text{V}$, $V_S = 4.3\text{V}$			30	μA
I_{LEAK}	OFF-State Leakage Current on $D\pm$, $DA/B\pm$	$0 < V_{D\pm, DA\pm, DB\pm} \leq 3.6\text{V}$, $V_S = 4.3\text{V}$	-2		2	μA
I_{OFF}	Power OFF Leakage Current on $D\pm$	$V_{D\pm} = 4.3\text{V}$, $V_S = 0\text{V}$	-2		2	μA
R_{ON}	ON Resistance	$V_{\text{IN/OUT}} = 0.4\text{V}$, $I_{\text{IN/OUT}} = 8\text{mA}$, $V_S = 3\text{V}$		4	6.5	Ω
ΔR_{ON}	ON Resistance Match Between Channels ⁽¹⁾	$V_{\text{IN/OUT}} = 0.4\text{V}$, $I_{\text{IN/OUT}} = 8\text{mA}$, $V_S = 3\text{V}$		0.35		Ω
$R_{\text{FLAT_ON}}$	R_{ON} Flatness ⁽²⁾	$0\text{V} < V_{\text{IN/OUT}} \leq 1.0\text{V}$, $I_{\text{IN/OUT}} = 8\text{mA}$, $V_S = 3\text{V}$		1		Ω
Capacitance						
C_{IN}	Control Pin Input Capacitance	$f = 240\text{MHz}$, $V_S = 0\text{V}$		1.5		pF
C_{ON}	ON Capacitance	$f = 240\text{MHz}$, $V_S = 3.6\text{V}$		7		pF
C_{OFF}	OFF Capacitance	$f = 240\text{MHz}$, $V_S = 3.6\text{V}$		3.5		pF

Notes:

- $\Delta R_{\text{ON(MAX)}} = |R_{\text{ON}}(\text{Channel1}) - R_{\text{ON}}(\text{Channel2})|$
- $R_{\text{FLAT_ON}}$ is defined as the difference between the maximum and minimum value of R_{ON} measured over specified $V_{\text{IN/OUT}}$ range.

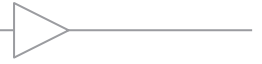

Typical Performance Characteristics

$T_A = 25^\circ\text{C}$, $V_S = +3\text{V}$; unless otherwise noted.

Eye Diagram

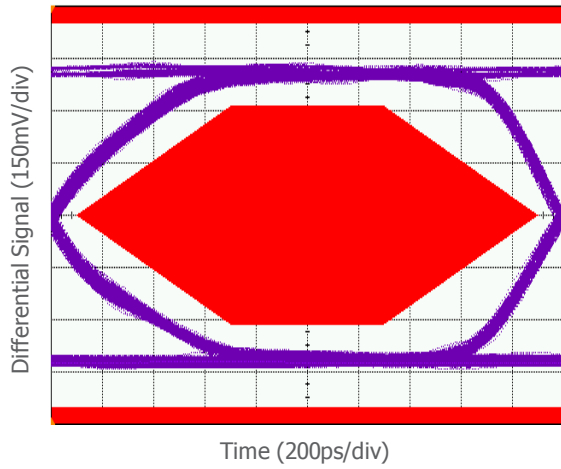

Off Isolation vs. Frequency

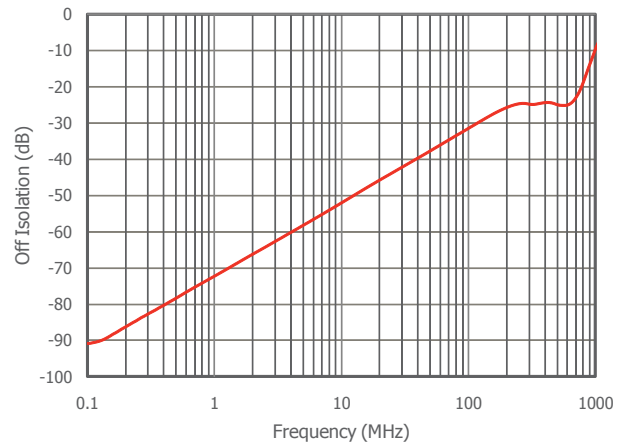

Crosstalk vs. Frequency

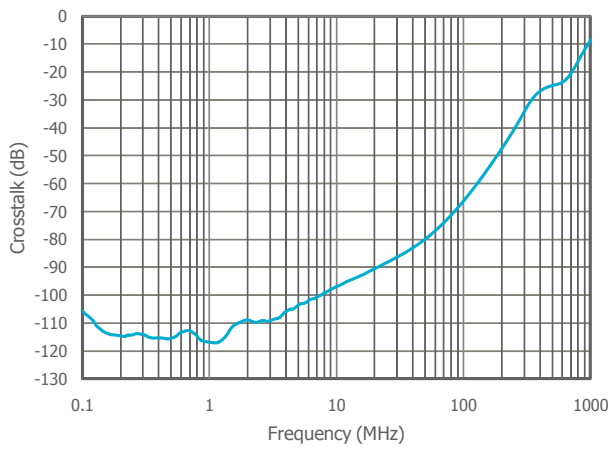

Gain vs. Frequency

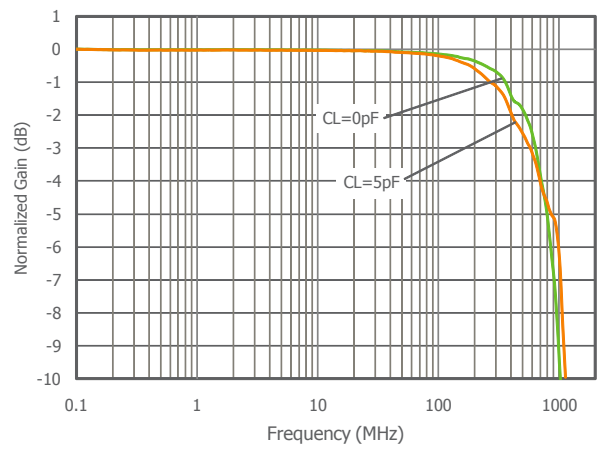



Timing Diagrams

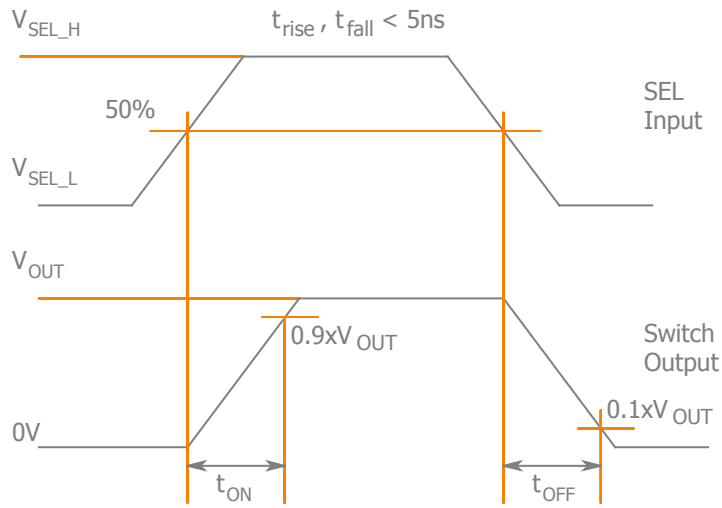

Figure 1. t_{ON} , t_{OFF}

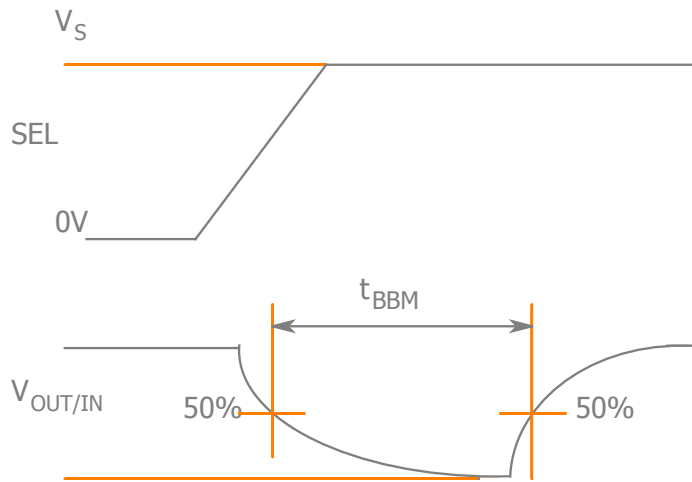
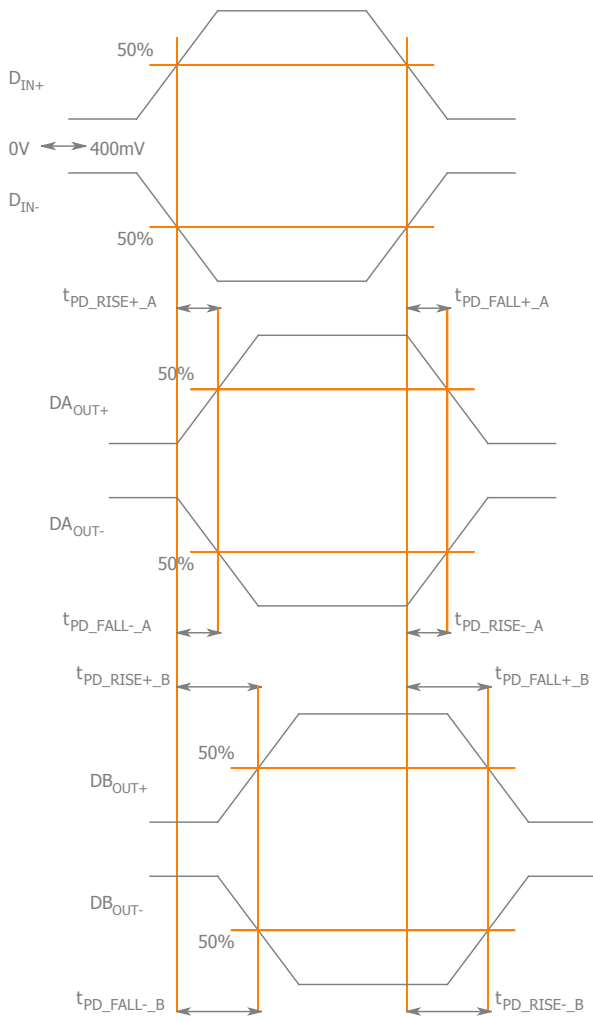
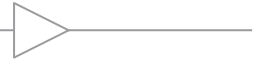

Figure 2. Break - Before - Make Time



Rise-Time Propagation Delay

t_{PD_RISE+}, t_{PD_RISE-}

Fall-Time Propagation Delay

t_{PD_FALL+}, t_{PD_FALL-}

Output Skew Between Switches

$$t_{SK(O)} = | (t_{PD_RISE+/-_A}) - (t_{PD_RISE+/-_B}) |$$

$$\text{OR } t_{SK(O)} = | (t_{PD_FALL+/-_A}) - (t_{PD_FALL+/-_B}) |$$

Output Skew Same Switch

$$t_{SK(P)} = | (t_{PD_RISE+_A/B}) - (t_{PD_FALL+_A/B}) |$$

$$\text{OR } t_{SK(P)} = | (t_{PD_RISE-_A/B}) - (t_{PD_FALL-_A/B}) |$$

Figure 3. Rise / Fall Propagation Delay & Skew



Mechanical Dimensions

MSOP-10 Package (compliant to JEDEC MO-187)

NOTE:

- 1) CONTROLLING DIMENSION: INCHES.
- 2) PACKAGE LENGTH DOES NOT INCLUDE MOLD FLASH, PROTRUSIONS OR GATE BURR.
- 3) PACKAGE WIDTH DOES NOT INCLUDE INTERLEAD FLASH OR PROTRUSIONS.

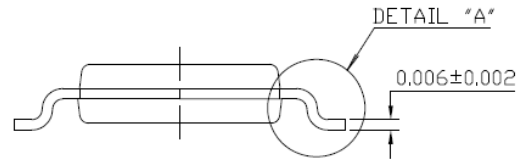
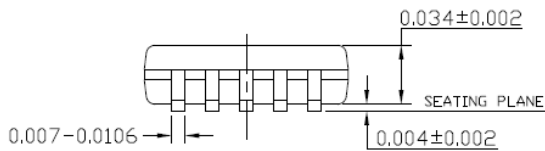
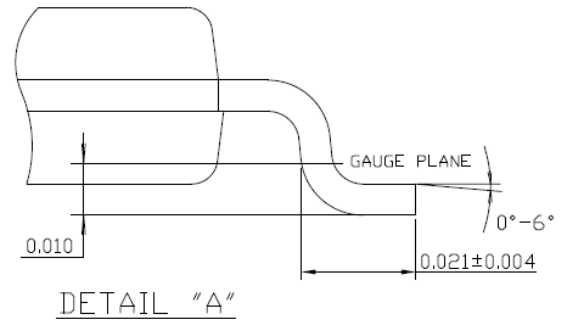
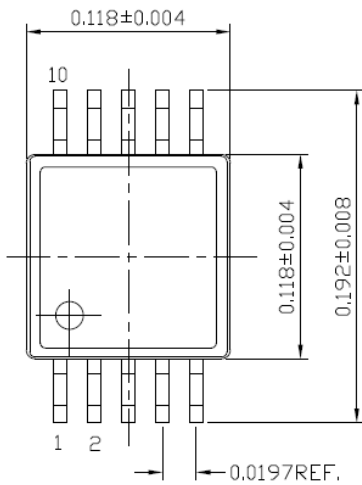

For additional information regarding our products, please visit CADEKA at: www.cadeca.com

CADEKA Headquarters Loveland, Colorado
 T: 970.663.5452
 T: 877.663.5452 (toll free)

CADEKA, the CADEKA logo design, COMLINEAR, and the COMLINEAR logo design are trademarks or registered trademarks of CADEKA Microcircuits LLC. All other brand and product names may be trademarks of their respective companies.

CADEKA reserves the right to make changes to any products and services herein at any time without notice. CADEKA does not assume any responsibility or liability arising out of the application or use of any product or service described herein, except as expressly agreed to in writing by CADEKA; nor does the purchase, lease, or use of a product or service from CADEKA convey a license under any patent rights, copyrights, trademark rights, or any other of the intellectual property rights of CADEKA or of third parties.

Copyright ©2009-2010 by CADEKA Microcircuits LLC. All rights reserved.