

# Comlinear<sup>®</sup> CLC1007, CLC2007, CLC4007

## Single, Dual, and Quad, Low Cost, High Speed RRO Amplifier

### FEATURES

- 260MHz bandwidth
- Fully specified at +3V, +5V and +/-5V supplies
- Output voltage range: 0.03V to 4.95V;  $V_S = +5$ ;  $R_L = 2k\Omega$
- Input voltage range: -0.3V to +4.1V;  $V_S = +5$
- 220V/ $\mu$ s slew rate
- 2.6mA supply current per amplifier
- $\pm 100$ mA linear output current
- $\pm 125$ mA short circuit current
- CLC2007 directly replaces AD8052, AD8042 and AD8092
- CLC1007 directly replaces AD8051, AD8041 and AD8091

### APPLICATIONS

- A/D driver
- Active filters
- CCD imaging systems
- CD/DVD ROM
- Coaxial cable drivers
- High capacitive load driver
- Portable/battery-powered applications
- Twisted pair driver
- Telecom and optical terminals
- Video driver

### General Description

The COMLINEAR CLC1007 (single), CLC2007 (dual) and CLC4007(quad) are low cost, voltage feedback amplifiers. These amplifiers are designed to operate on +3V to +5V, or  $\pm 5$ V supplies. The input voltage range extends 300mV below the negative rail and 0.9V below the positive rail.

The CLC1007, CLC2007, and CLC4007 offer superior dynamic performance with a 260MHz small signal bandwidth and 220V/ $\mu$ s slew rate. The combination of low power, high output current drive, and rail-to-rail performance make these amplifiers well suited for battery-powered communication/computing systems and video applications

The combination of low cost and high performance make the CLC1007, CLC2007, and CLC4007 suitable for high volume applications in both consumer and industrial applications such as wireless phones, scanners, and color copiers and video transmission.

### Large Signal Frequency Response at +/-5V

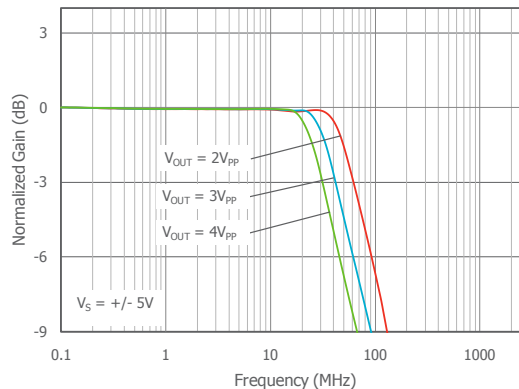

### Ordering Information

Part Number	Package	MSL Rating	Pb-Free	RoHS Compliant	Operating Temperature	Packaging Method
CLC1007ISO8	SOIC-8	MSL-3	Yes	Yes	-40°C to +125°C	Reel
CLC1007ISTX	TSOT-5	MSL-1	Yes	Yes	-40°C to +125°C	Reel
CLC2007ISO8	SOIC-8	MSL-3	Yes	Yes	-40°C to +125°C	Rail
CLC2007ISO8X	SOIC-8	MSL-3	Yes	Yes	-40°C to +125°C	Reel
<b>CLC2007IMP8X*</b>	MSOP-8	MSL-1	Yes	Yes	-40°C to +125°C	Reel
CLC4007ISO14	SOIC-14	MSL-3	Yes	Yes	-40°C to +125°C	Rail
CLC4007ISO14X	SOIC-14	MSL-3	Yes	Yes	-40°C to +125°C	Reel
<b>CLC4007ITP14*</b>	TSSOP-14	TBD	Yes	Yes	-40°C to +125°C	Rail
<b>CLC4007ITP14X*</b>	TSSOP-14	TBD	Yes	Yes	-40°C to +125°C	Reel

\*Advance Information, contact CADEKA for availability.



## CLC1007 Pin Configurations

### TSOT-5

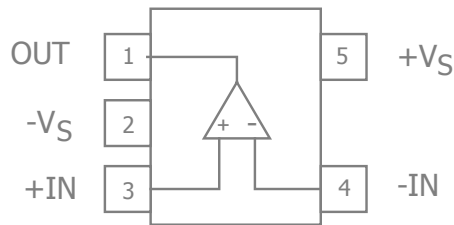

## CLC1007 Pin Assignments

### TSOT-5

Pin No.	Pin Name	Description
1	OUT	Output
2	-Vs	Negative supply
3	+IN	Positive input
4	-IN	Negative input
5	+Vs	Positive supply

### SOIC-8

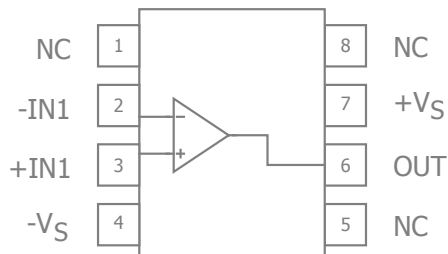

### SOIC-8

Pin No.	Pin Name	Description
1	NC	No Connect
2	-IN	Negative input
3	+IN	Positive input
4	-Vs	Negative supply
5	NC	No Connect
6	OUT	Negative input
7	+Vs	Positive supply
8	NC	No Connect

## CLC2007 Pin Configuration

### SOIC-8 / MSOP-8

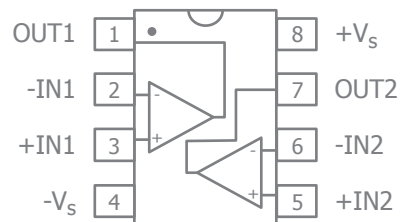

## CLC2007 Pin Assignments

### SOIC-8 / MSOP-8

Pin No.	Pin Name	Description
1	OUT1	Output, channel 1
2	-IN1	Negative input, channel 1
3	+IN1	Positive input, channel 1
4	-Vs	Negative supply
5	+IN2	Positive input, channel 2
6	-IN2	Negative input, channel 2
7	OUT2	Output, channel 2
8	+Vs	Positive supply



## CLC4007 Pin Configuration

### SOIC/TSSOP

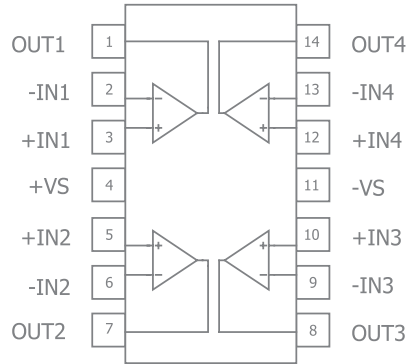

## CLC4007 Pin Assignments

### SOIC/TSSOP

Pin No.	Pin Name	Description
1	OUT1	Output, channel 1
2	-IN1	Negative input, channel 1
3	+IN1	Positive input, channel 1
4	+VS	Positive supply
5	+IN2	Positive input, channel 2
6	-IN2	Negative input, channel 2
7	OUT2	Output, channel 2
8	OUT3	Output, channel 3
9	-IN3	Negative input, channel 3
10	+IN3	Positive input, channel 3
11	-VS	Negative supply
12	+IN4	Positive input, channel 4
13	-IN4	Negative input, channel 4
14	OUT4	Output, channel 4



## Absolute Maximum Ratings

The safety of the device is not guaranteed when it is operated above the "Absolute Maximum Ratings". The device should not be operated at these "absolute" limits. Adhere to the "Recommended Operating Conditions" for proper device function. The information contained in the Electrical Characteristics tables and Typical Performance plots reflect the operating conditions noted on the tables and plots.

Parameter	Min	Max	Unit
Supply Voltage	0	+14	V
Input Voltage Range	-V <sub>S</sub> -0.5V	+V <sub>S</sub> +0.5V	V

## Reliability Information

Parameter	Min	Typ	Max	Unit
Junction Temperature			150	°C
Storage Temperature Range	-65		170	°C
Lead Temperature (Soldering, 10s)			260	°C
Package Thermal Resistance				
5-Lead SOT23		221		°C/W
8-Lead MSOP		139		°C/W
8-Lead SOIC		100		°C/W
14-Lead SOIC		88		°C/W
14-Lead TSSOP		96		°C/W

Notes:

Package thermal resistance ( $\theta_{JA}$ ), JEDEC standard, multi-layer test boards, still air.

## ESD Protection

Product	CLC1007		CLC2007		CLC4007	
	TSOT-5	SOIC-8	MSOP-8	SOIC-8	TSSOP-14	SOIC-14
Human Body Model (HBM)	1kV	TBD	TBD	1kV	TBD	TBD
Charged Device Model (CDM)	2kV	TBD	TBD	2kV	TBD	TBD

## Recommended Operating Conditions

Parameter	Min	Typ	Max	Unit
Operating Temperature Range	-40		+125	°C
Supply Voltage Range	2.7		12.6	V



## Electrical Characteristics at +3V

$T_A = 25^\circ\text{C}$ ,  $R_f = 1.5\text{k}\Omega$ ,  $R_L = 2\text{k}\Omega$  to  $V_S/2$ ,  $G = 2$ ; unless otherwise noted.

Symbol	Parameter	Conditions	Min	Typ	Max	Units
Frequency Domain Response						
GBWP	-3dB Gain Bandwidth Product	$G = +11$ , $V_{OUT} = 0.2V_{pp}$		90		MHz
UGBW	Unity Gain Bandwidth	$V_{OUT} = 0.2V_{pp}$ , $R_f = 0$		245		MHz
BW <sub>SS</sub>	-3dB Bandwidth	$V_{OUT} = 0.2V_{pp}$		85		MHz
$f_{0.1dB}$	0.1dB gain flatness	$V_{OUT} = 0.2V_{pp}$ , $R_L = 150\Omega$		16		MHz
BW <sub>LS</sub>	Large Signal Bandwidth	$V_{OUT} = 2V_{pp}$		55		MHz
DG	Differential Gain	DC-coupled Output		0.03		%
		AC-coupled Output		0.04		%
DP	Differential Phase	DC-coupled Output		0.03		°
		AC-coupled Output		0.06		°
Time Domain Response						
$t_R$ , $t_F$	Rise and Fall Time	$V_{OUT} = 0.2V$ step; (10% to 90%)		5		ns
$t_S$	Settling Time to 0.1%	$V_{OUT} = 1V$ step		25		ns
OS	Overshoot	$V_{OUT} = 0.2V$ step		8		%
SR	Slew Rate	$G = -1$ , 2V step		175		V/ $\mu$ s
Distortion/Noise Response						
THD	Total Harmonic Distortion	1MHz, $V_{out} = 1V_{pp}$		75		dBc
$e_n$	Input Voltage Noise	> 50kHz		16		nV/ $\sqrt{\text{Hz}}$
$X_{TALK}$	Crosstalk	$f = 5\text{MHz}$		58		dB
DC Performance						
$V_{IO}$	Input Offset Voltage			0.5		mV
$dV_{IO}$	Average Drift			5		$\mu\text{V}/^\circ\text{C}$
$I_b$	Input Bias Current			1.4		$\mu\text{A}$
$dI_b$	Average Drift			2		nA/ $^\circ\text{C}$
$I_{os}$	Input Offset Current			0.05		$\mu\text{A}$
PSRR	Power Supply Rejection Ratio	DC		102		dB
$A_{OL}$	Open-Loop Gain	$R_L = 2\text{k}\Omega^{(2)}$		92		dB
$I_S$	Supply Current	per channel		2.6		mA
Input Characteristics						
$C_{IN}$	Input Capacitance			0.5		pF
CMIR	Common Mode Input Range			-0.3 to 2.1		V
CMRR	Common Mode Rejection Ratio	DC, $V_{cm} = 0V$ to 1.5V		100		dB
Output Characteristics						
$V_{OUT}$	Output Voltage Swing	$R_L = 150\Omega$		0.3 to 2.75		V
		$R_L = 2\text{k}\Omega$		0.02 to 2.96		V
$I_{OUT}$	Output Current			$\pm 100$		mA
$I_{SC}$	Short-Circuit Output Current	$V_{OUT} = V_S / 2$		$\pm 125$		mA
$V_S$	Power Supply Operating Range			2.7 to 12		V

### Notes:

- 100% tested at 25°C
- Guaranteed by characterization, simulation or statistical analysis



## Electrical Characteristics at +5V

$T_A = 25^\circ\text{C}$ ,  $R_f = 1.5\text{k}\Omega$ ,  $R_L = 2\text{k}\Omega$  to  $V_S/2$ ,  $G = 2$ ; unless otherwise noted.

Symbol	Parameter	Conditions	Min	Typ	Max	Units
Frequency Domain Response						
GBWP	-3dB Gain Bandwidth Product	$G = +11$ , $V_{OUT} = 0.2V_{pp}$		95		MHz
UGBW	Unity Gain Bandwidth	$V_{OUT} = 0.2V_{pp}$ , $R_f = 0$		250		MHz
BW <sub>SS</sub>	-3dB Bandwidth	$V_{OUT} = 0.2V_{pp}$		85		MHz
$f_{0.1dB}$	0.1dB gain flatness	$V_{OUT} = 0.2V_{pp}$ , $R_L = 150\Omega$		35		MHz
BW <sub>LS</sub>	Large Signal Bandwidth	$V_{OUT} = 2V_{pp}$		65		MHz
DG	Differential Gain	DC-coupled Output		0.03		%
		AC-coupled Output		0.04		%
DP	Differential Phase	DC-coupled Output		0.03		°
		AC-coupled Output		0.06		°
Time Domain Response						
$t_R$ , $t_F$	Rise and Fall Time	$V_{OUT} = 0.2V$ step		5		ns
$t_S$	Settling Time to 0.1%	$V_{OUT} = 2V$ step		25		ns
OS	Overshoot	$V_{OUT} = 0.2V$ step		5		%
SR	Slew Rate	$G = -1$ , 4V step,		220		V/ $\mu$ s
Distortion/Noise Response						
THD	Total Harmonic Distortion	1MHz, $V_{OUT} = 2V_{pp}$		-75		dB
$e_n$	Input Voltage Noise	> 50kHz		16		nV/ $\sqrt{\text{Hz}}$
$X_{TALK}$	Crosstalk	$f = 5\text{MHz}$		58		dB
DC Performance						
$V_{IO}$	Input Offset Voltage <sup>(1)</sup>		-7	0.5	7	mV
$dV_{IO}$	Average Drift			5		$\mu\text{V}/^\circ\text{C}$
$I_b$	Input Bias Current <sup>(1)</sup>		-2	1.4	2	$\mu\text{A}$
$dI_b$	Average Drift			2		nA/ $^\circ\text{C}$
$I_{os}$	Input Offset Current <sup>(1)</sup>		-0.75	0.05	0.75	$\mu\text{A}$
PSRR	Power Supply Rejection Ratio <sup>(1)</sup>	DC	80	102		dB
$A_{OL}$	Open-Loop Gain	$R_L = 2\text{k}\Omega$ <sup>(2)</sup>	80	92		dB
$I_S$	Supply Current <sup>(1)</sup>	per channel		2.6	4	mA
Input Characteristics						
$C_{IN}$	Input Capacitance			0.5		pF
CMIR	Common Mode Input Range			-0.3 to 4.1		V
CMRR	Common Mode Rejection Ratio <sup>(1)</sup>	DC, $V_{cm} = 0V$ to 3.5V	75	100		dB
Output Characteristics						
$V_{OUT}$	Output Voltage Swing	$R_L = 150\Omega$ <sup>(1)</sup>	4.65	0.1 to 4.9	0.35	V
		$R_L = 2\text{k}\Omega$		0.03 to 4.95		V
$I_{OUT}$	Output Current			$\pm 100$		mA
$I_{SC}$	Short-Circuit Output Current	$V_{OUT} = V_S / 2$		$\pm 125$		mA
$V_S$	Power Supply Operating Range			2.7 to 12		V

### Notes:

- 100% tested at 25°C
- Guaranteed by characterization, simulation or statistical analysis



## Electrical Characteristics at $\pm 5V$

$T_A = 25^\circ C$ ,  $R_f = 1.5k\Omega$ ,  $R_L = 2k\Omega$  to GND,  $G = 2$ ; unless otherwise noted.

Symbol	Parameter	Conditions	Min	Typ	Max	Units
Frequency Domain Response						
GBWP	-3dB Gain Bandwidth Product	$G = +11$ , $V_{OUT} = 0.2V_{pp}$		90		MHz
UGBW	Unity Gain Bandwidth	$V_{OUT} = 0.2V_{pp}$ , $R_f = 0$		260		MHz
BW <sub>SS</sub>	-3dB Bandwidth	$V_{OUT} = 0.2V_{pp}$		85		MHz
$f_{0.1dB}$	0.1dB gain flatness	$V_{OUT} = 0.2V_{pp}$ , $R_L = 150\Omega$		22		MHz
BW <sub>LS</sub>	Large Signal Bandwidth	$V_{OUT} = 2V_{pp}$		65		MHz
DG	Differential Gain	DC-coupled Output		0.03		%
		AC-coupled Output		0.04		%
DP	Differential Phase	DC-coupled Output		0.03		°
		AC-coupled Output		0.06		°
Time Domain Response						
$t_R$ , $t_F$	Rise and Fall Time	$V_{OUT} = 0.2V$ step		5		ns
$t_S$	Settling Time to 0.1%	$V_{OUT} = 2V$ step, $R_L = 100\Omega$		25		ns
OS	Overshoot	$V_{OUT} = 0.2V$ step		5		%
SR	Slew Rate	$G = -1$ , 5V step		225		V/ $\mu s$
Distortion/Noise Response						
THD	Total Harmonic Distortion	1MHz, $V_{OUT} = 2V_{pp}$		76		dBc
$e_n$	Input Voltage Noise	> 50kHz		16		nV/ $\sqrt{Hz}$
$X_{TALK}$	Crosstalk	f=5MHz		58		dB
DC Performance						
$V_{IO}$	Input Offset Voltage			0.5		mV
$dV_{IO}$	Average Drift			5		$\mu V/^\circ C$
$I_b$	Input Bias Current			1.3		$\mu A$
$dI_b$	Average Drift			2		nA/ $^\circ C$
$I_{os}$	Input Offset Current			0.04		$\mu A$
PSRR	Power Supply Rejection Ratio	DC		102		dB
$A_{OL}$	Open-Loop Gain	$R_L = 2k\Omega^{(2)}$		92		dB
$I_S$	Supply Current	per channel		2.6		mA
Input Characteristics						
$C_{IN}$	Input Capacitance			0.5		pF
CMIR	Common Mode Input Range			-5.3 to 4.1		V
CMRR	Common Mode Rejection Ratio <sup>(1)</sup>	DC, $V_{cm} = -5V$ to 3.5V		100		dB
Output Characteristics						
$V_{OUT}$	Output Voltage Swing	$R_L = 150\Omega$		-4.8 to 4.8		V
		$R_L = 2k\Omega$		-4.95 to 4.93		V
$I_{OUT}$	Output Current			+/-100		mA
$I_{SC}$	Short-Circuit Output Current	$V_{OUT} = V_S / 2$		+/-125		mA
$V_S$	Power Supply Operating Range			2.7 to 12		V

### Notes:

- 100% tested at 25°C
- Guaranteed by characterization, simulation or statistical analysis



## Typical Performance Characteristics

TA = 25°C, V<sub>S</sub> = +3V, R<sub>L</sub> = 2kΩ to V<sub>S</sub>/2, A<sub>V</sub> = +2, R<sub>F</sub> = 1.5kΩ ; unless otherwise noted.

Non-Inverting Freq. Resp.

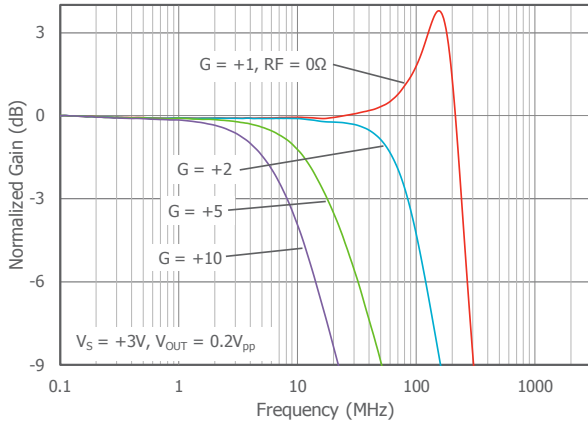

Inverting Freq. Resp.

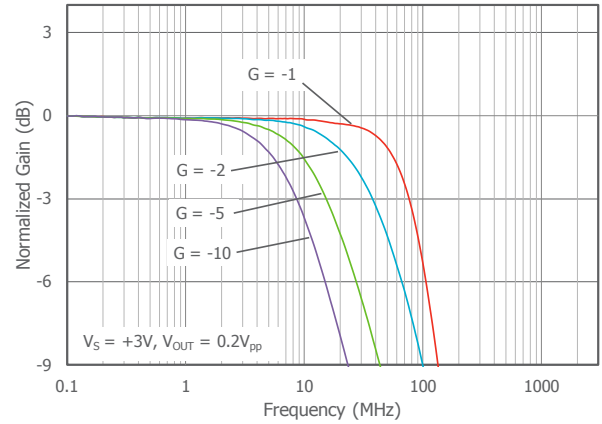

Freq. Resp. vs CL

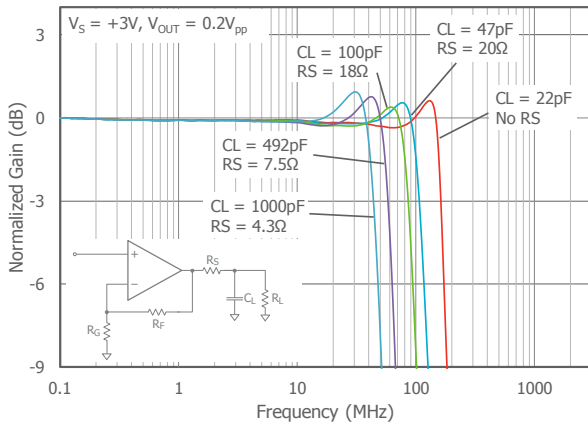

Freq. Resp. vs RL

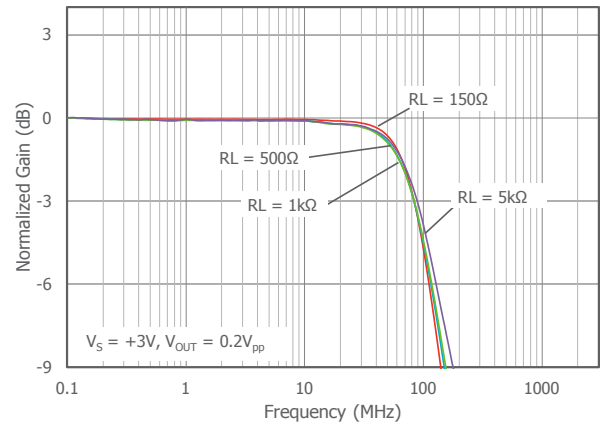

Large Signal Freq. Resp.

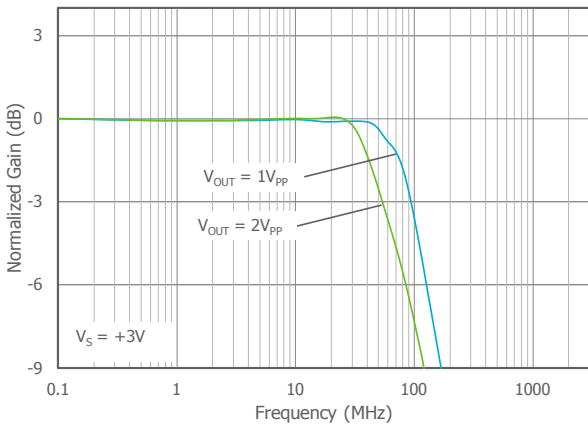

-3dB BW vs Output Voltage

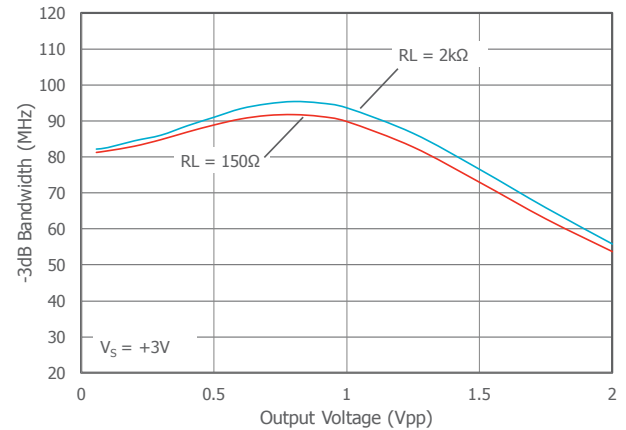

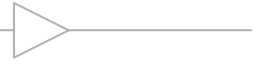

## Typical Performance Characteristics

TA = 25°C, VS = +3V, RL = 2kΩ to VS/2, AV=+2, RF=1.5kΩ ; unless otherwise noted.

Input Voltage Noise vs Freq.

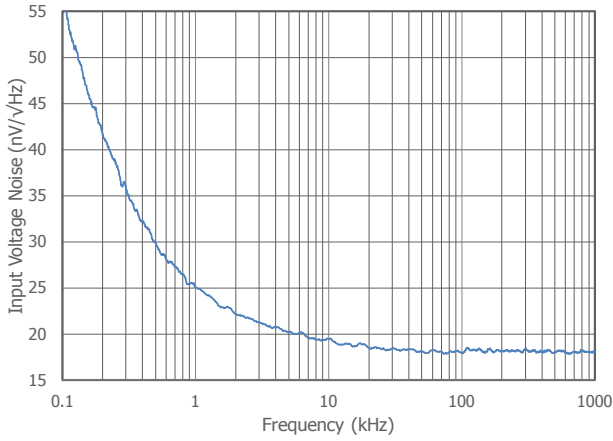

2nd Harmonic Distortion Vs RL over Freq.

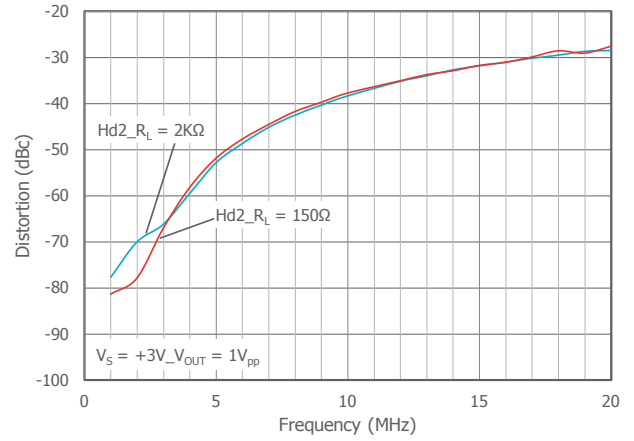

3rd Harmonic Distortion Vs RL over Freq.

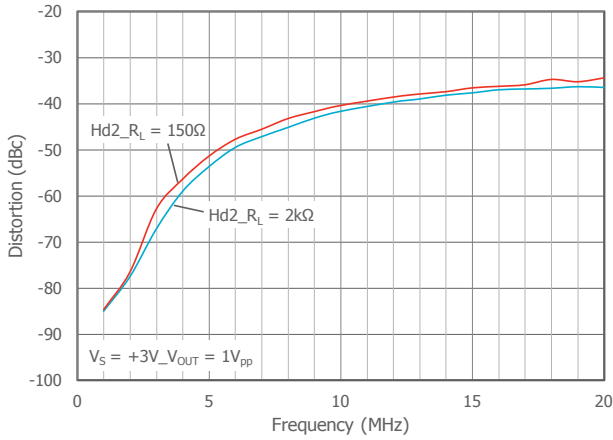

2nd Harmonic Distortion Vs Vo over Freq.

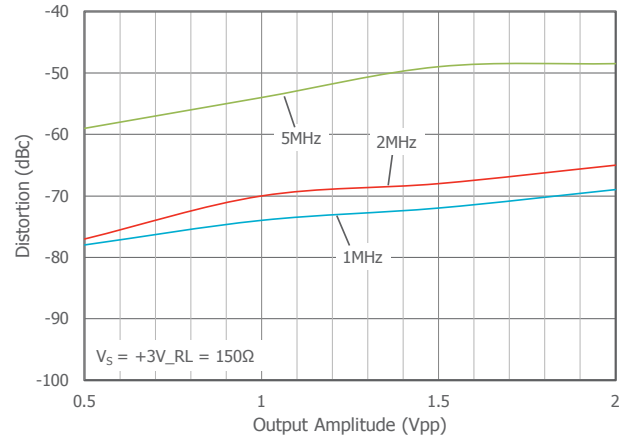

3rd Harmonic Distortion Vs Vo over Freq.

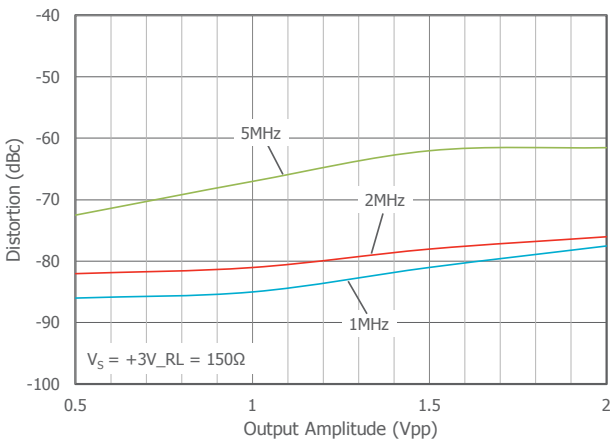

Non-Inverting Small Signal Pulse Response

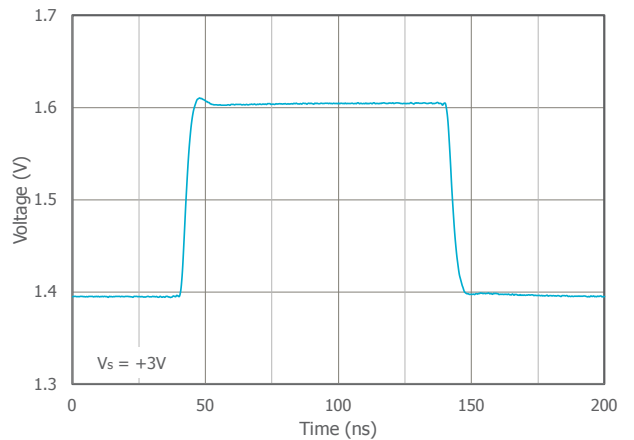

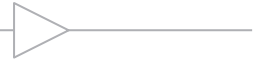

## Typical Performance Characteristics

TA = 25°C, VS = +3V, RL = 2kΩ to VS/2, AV=+2, RF=1.5kΩ ; unless otherwise noted.

Non-Inverting Large Signal Pulse Response

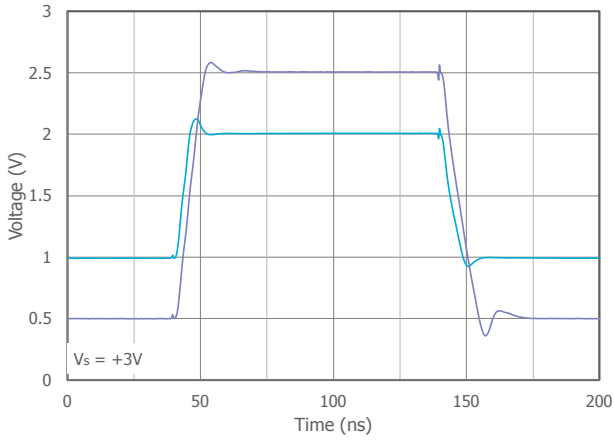

Crosstalk vs Frequency

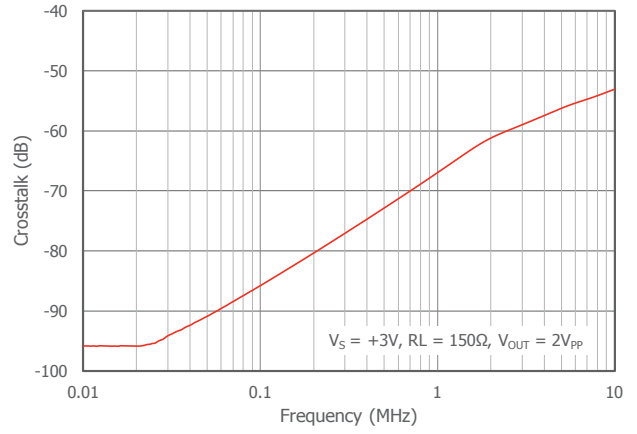

Differential Gain & Phase\_DC Coupled

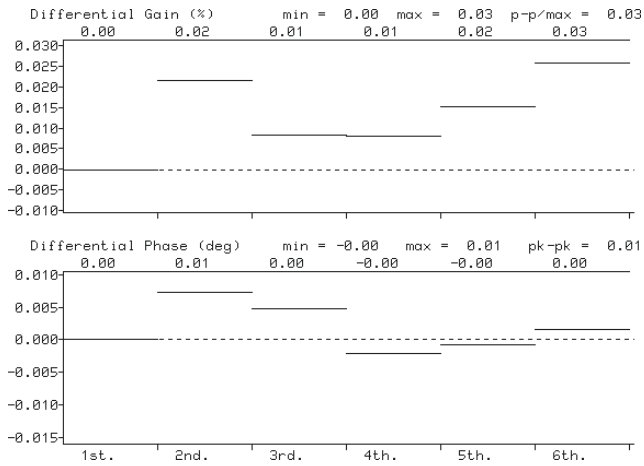

Differential Gain & Phase\_AC Coupled

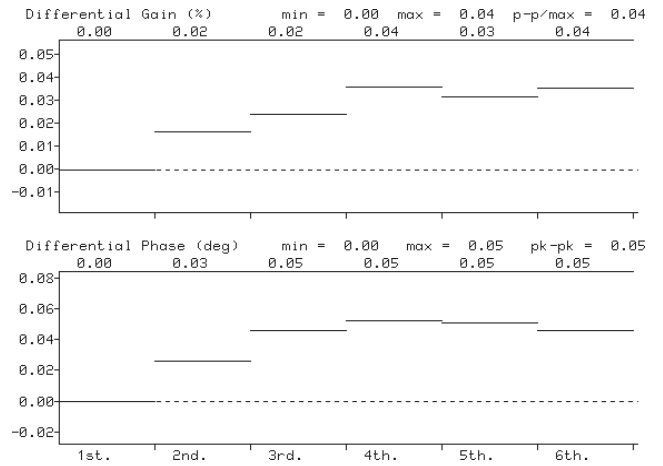

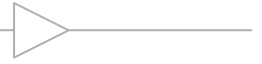

## Typical Performance Characteristics

TA = 25°C, VS = +5V, RL = 2kΩ to VS/2, AV=+2, RF=1.5kΩ ; unless otherwise noted.

Non-Inverting Freq. Resp.

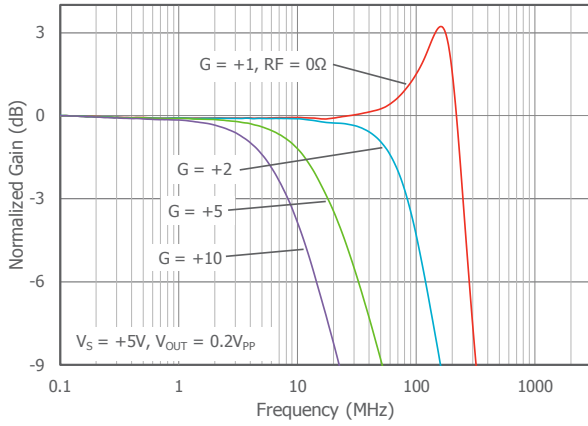

Inverting Freq. Resp.

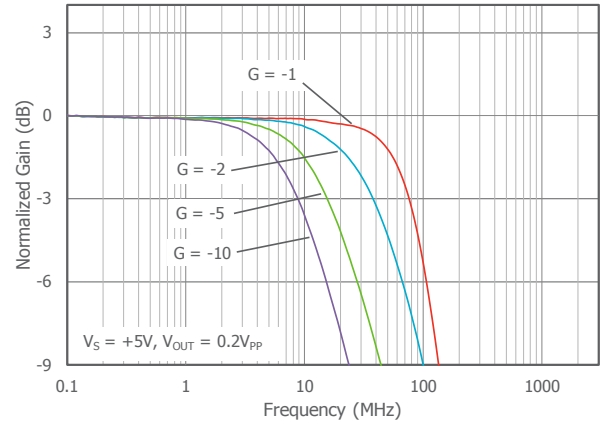

Freq. Resp. vs CL

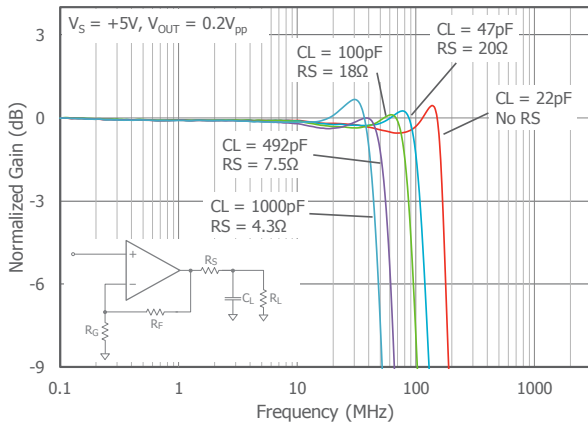

Freq. Resp. vs RL

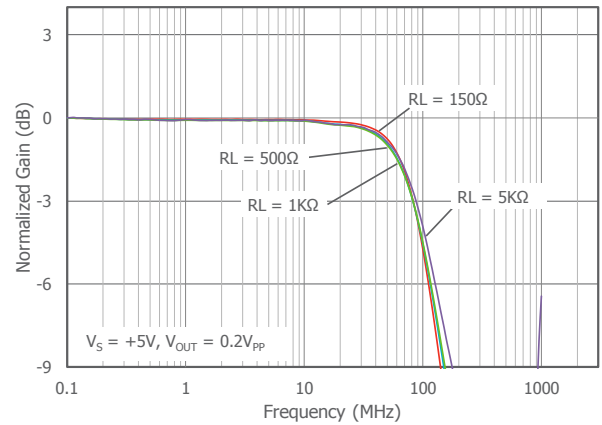

Large Signal Freq. Resp.

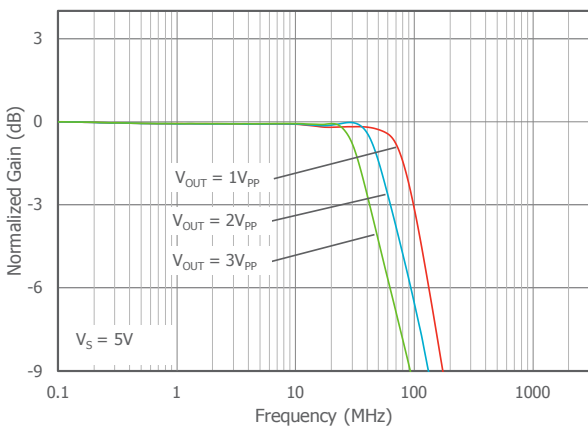

-3dB BW vs Output Voltage

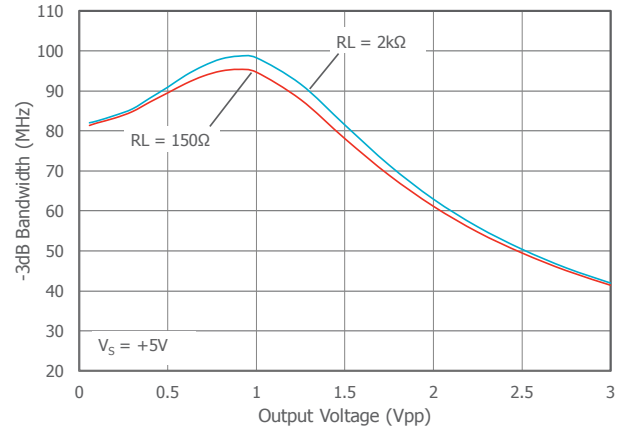

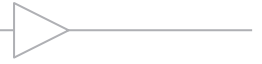

### Typical Performance Characteristics

TA = 25°C, VS = +5V, RL = 2kΩ to VS/2, AV=+2, RF=1.5kΩ ; unless otherwise noted.

Input Voltage Noise vs Freq.

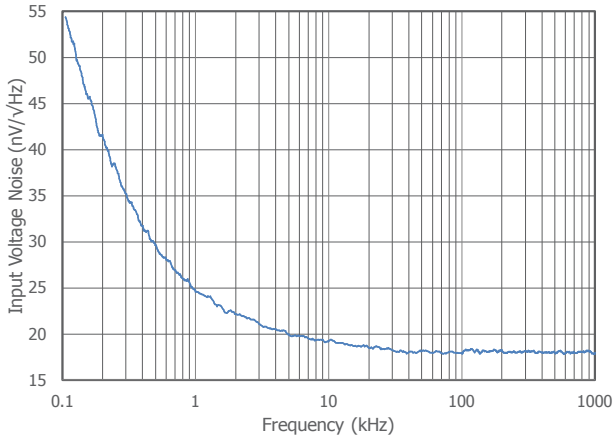

2nd Harmonic Distortion Vs RL over Freq.

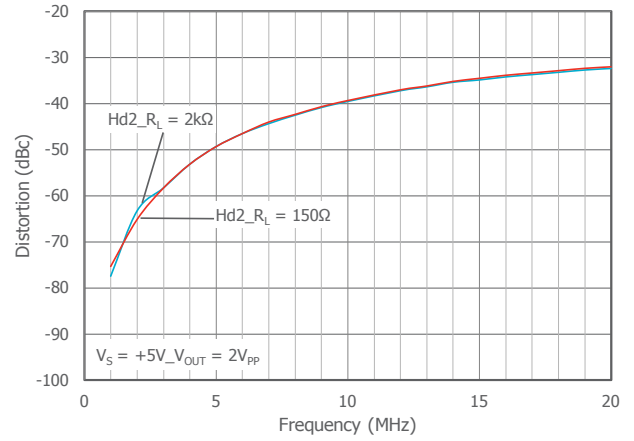

3rd Harmonic Distortion Vs RL over Freq.

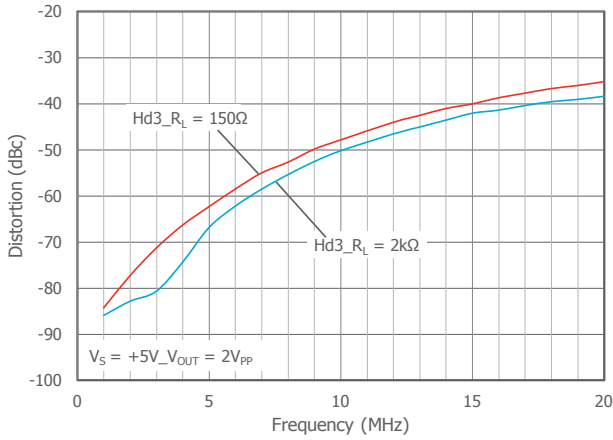

2nd Harmonic Distortion Vs Vo over Freq.

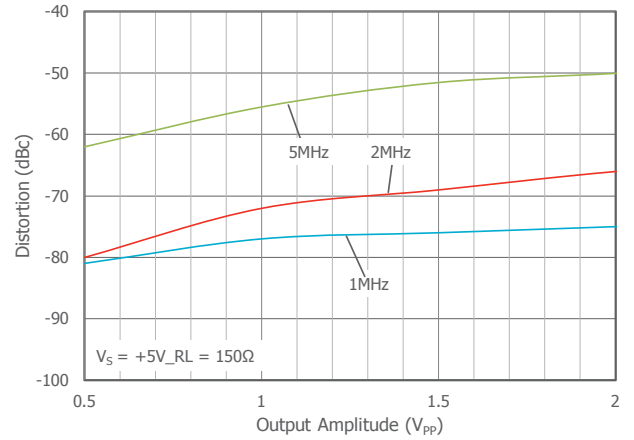

3rd Harmonic Distortion Vs Vo over Freq.

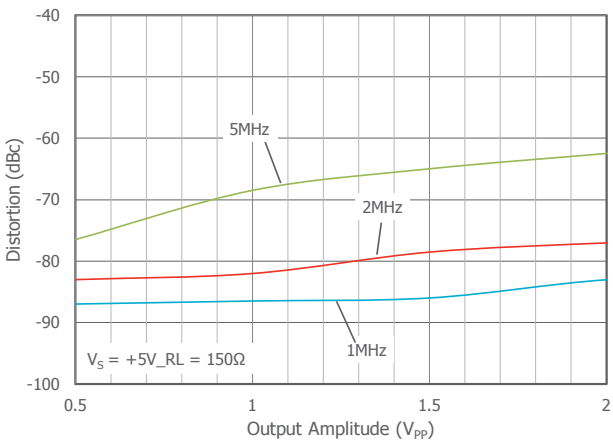

Non-Inverting Small Signal Pulse Response

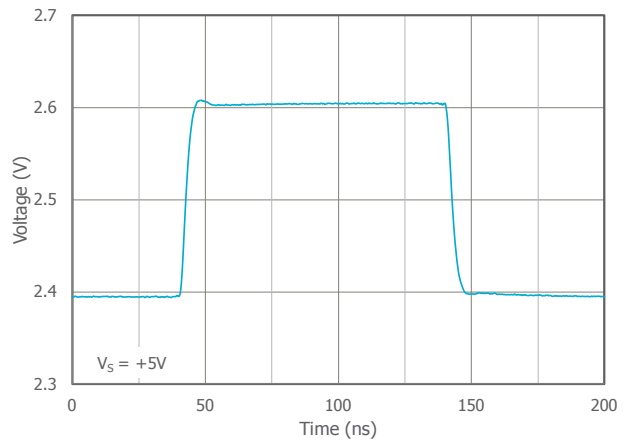



## Typical Performance Characteristics

TA = 25°C, V<sub>S</sub> = +5V, R<sub>L</sub> = 2kΩ to V<sub>S</sub>/2, A<sub>V</sub>=+2, R<sub>F</sub>=1.5kΩ ; unless otherwise noted.

### Non-Inverting Large Signal Pulse Response

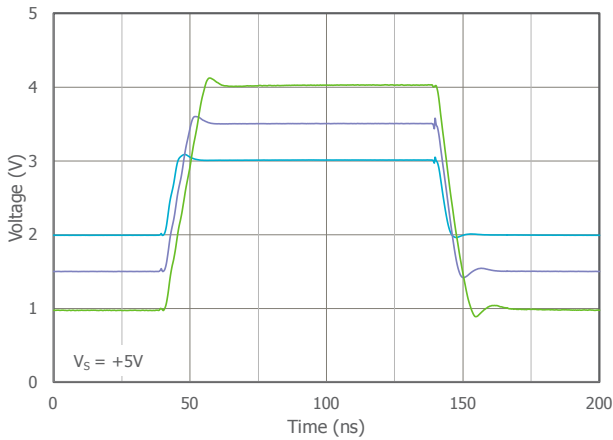

### Crosstalk vs Frequency

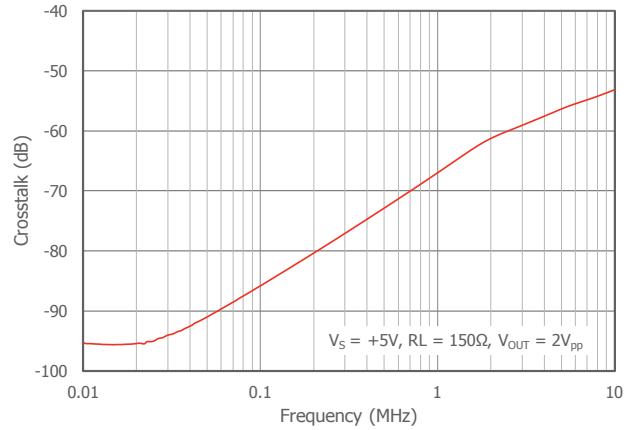

### Differential Gain & Phase\_DC Coupled

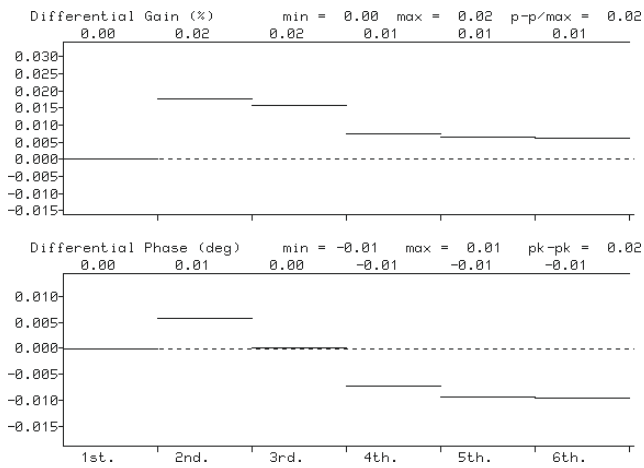

### Differential Gain & Phase\_AC Coupled

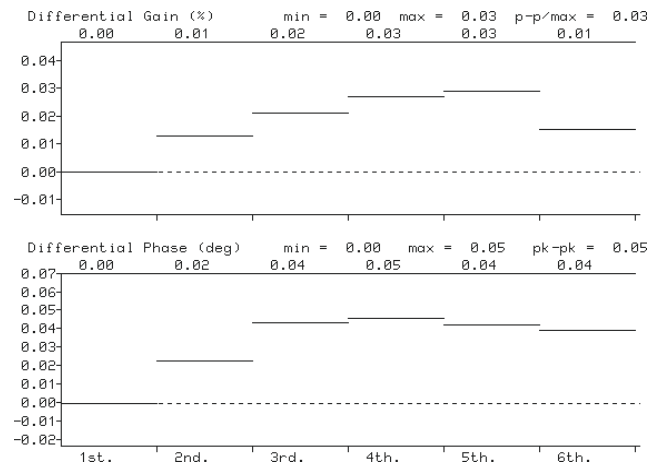



## Typical Performance Characteristics

TA = 25°C, V<sub>S</sub> = ±5V, R<sub>L</sub> = 2kΩ to GND, A<sub>V</sub>=+2, R<sub>F</sub>=1.5kΩ ; unless otherwise noted.

Non-Inverting Freq. Resp.

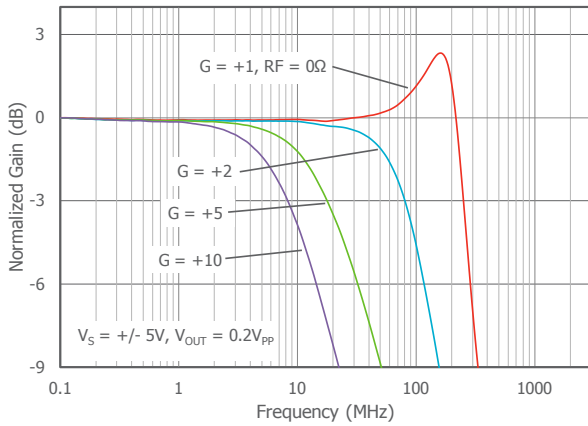

Inverting Freq. Resp.

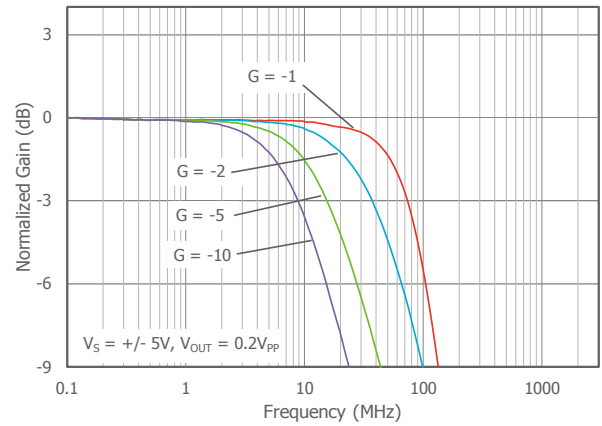

Freq. Resp. vs CL

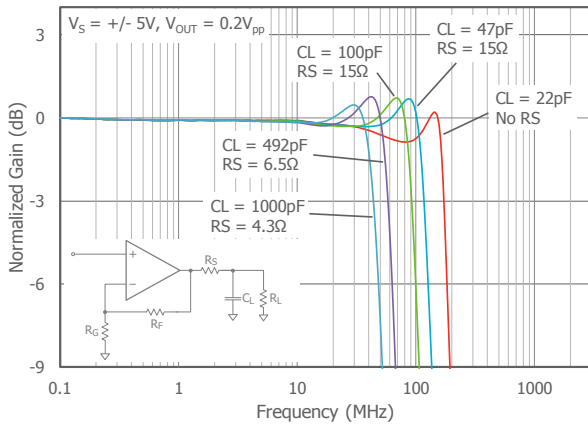

Freq. Resp. vs RL

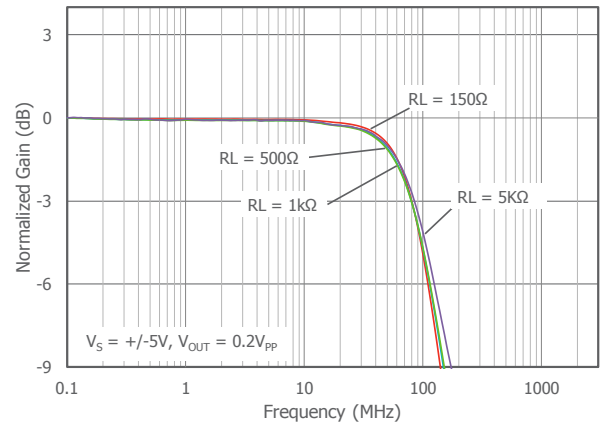

Large Signal Freq. Resp.

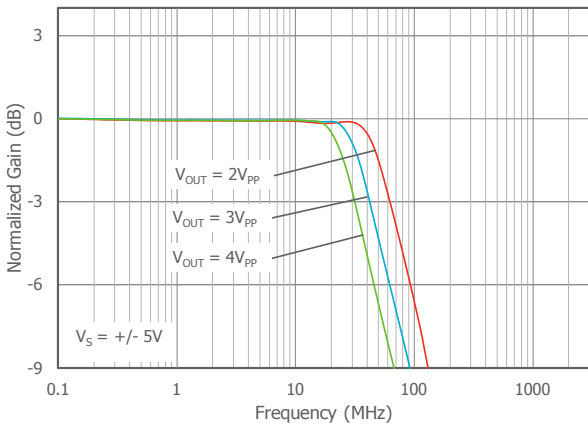

-3dB BW vs Output Voltage

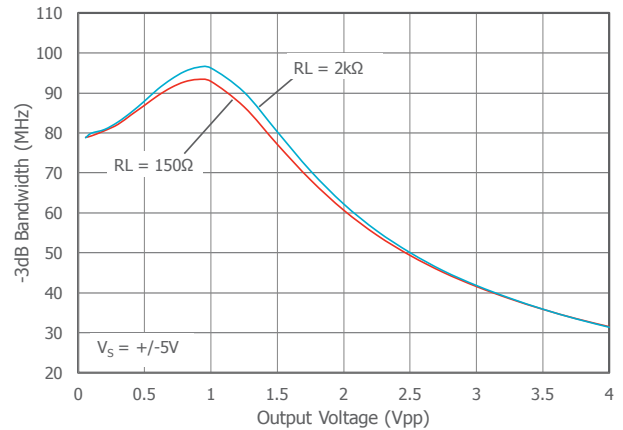

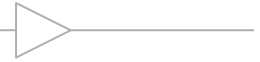

## Typical Performance Characteristics

TA = 25°C, V<sub>S</sub> = ±5V, R<sub>L</sub> = 2kΩ to GND, A<sub>V</sub>=+2, R<sub>F</sub>=1.5kΩ ; unless otherwise noted.

Input Voltage Noise vs Freq.

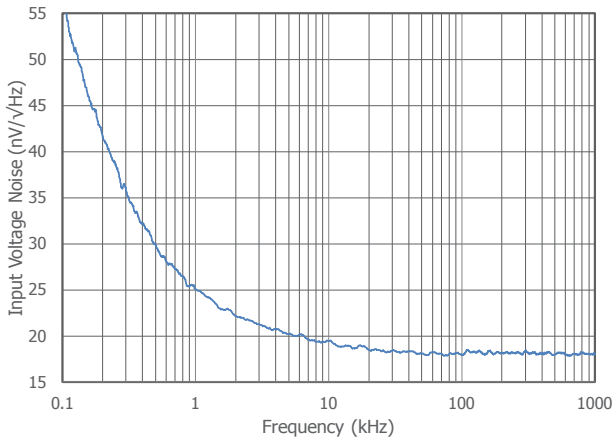

2nd Harmonic Distortion Vs RL over Freq.

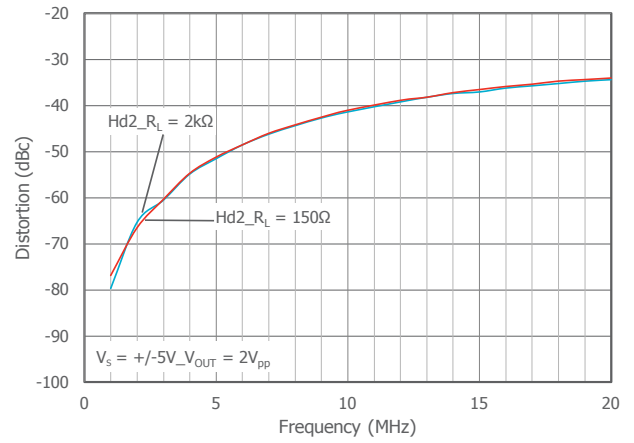

3rd Harmonic Distortion Vs RL over Freq.

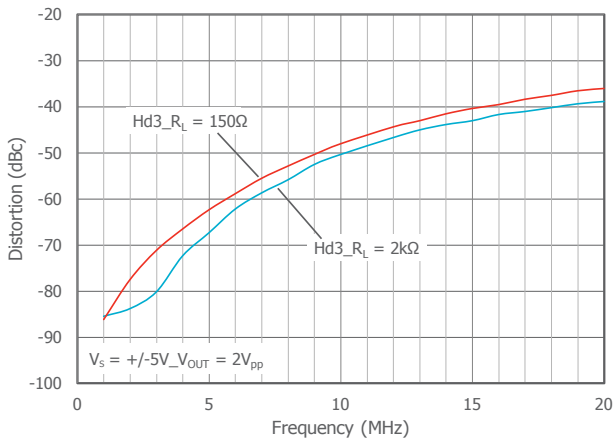

2nd Harmonic Distortion Vs Vo over Freq.

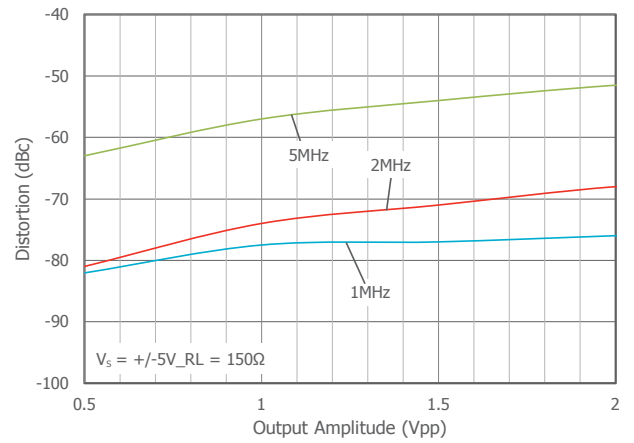

3rd Harmonic Distortion Vs Vo over Freq.

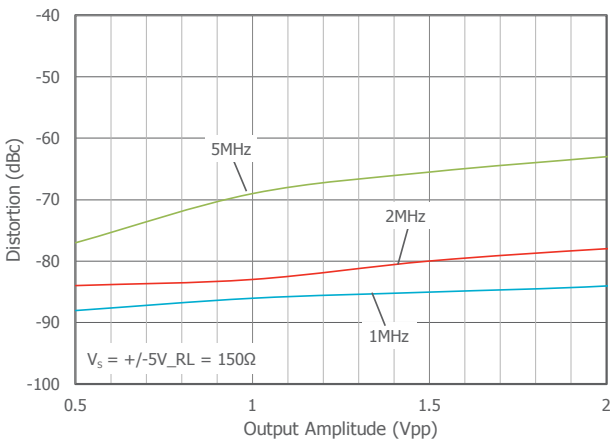

Non-Inverting Small Signal Pulse Response

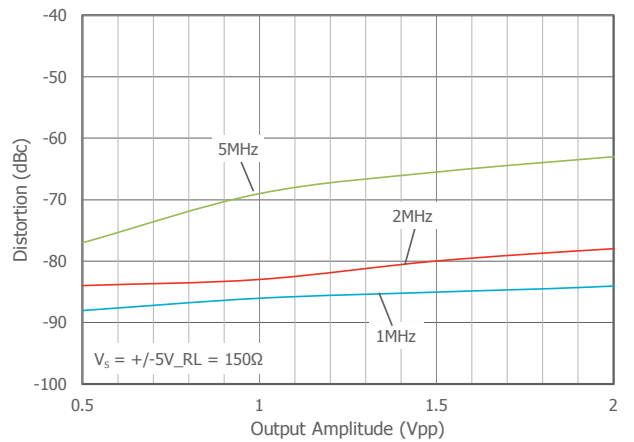



## Typical Performance Characteristics

TA = 25°C, VS = ±5V, RL = 2kΩ to GND, AV=+2, RF=1.5kΩ ; unless otherwise noted.

### Non-Inverting Large Signal Pulse Response

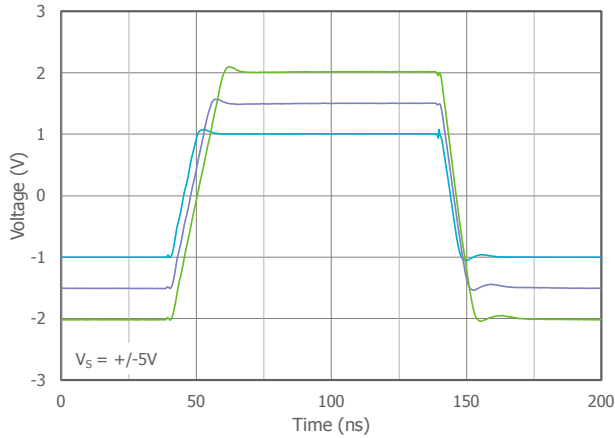

### Crosstalk vs Frequency

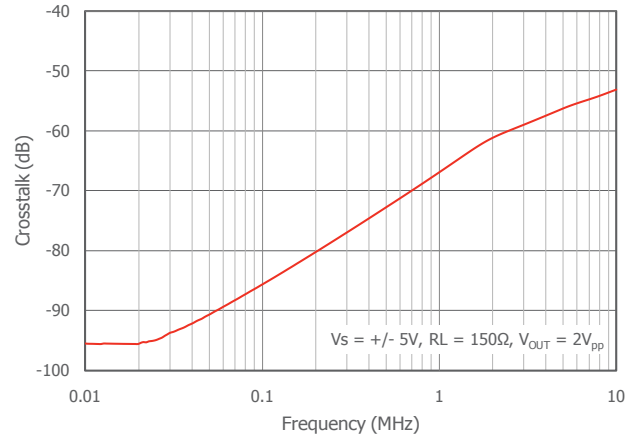

### Differential Gain & Phase\_DC Coupled

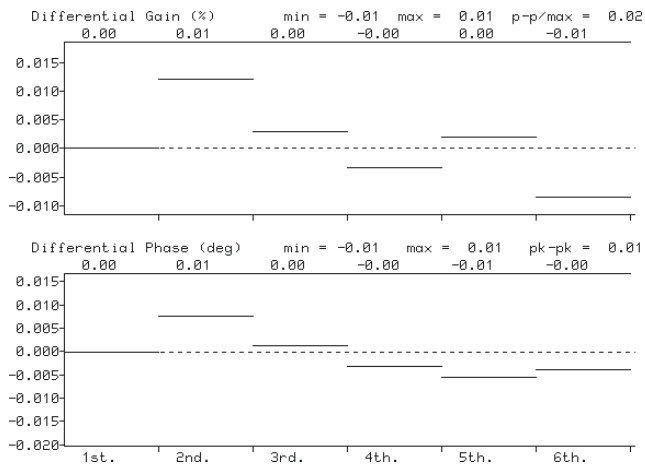

### Differential Gain & Phase\_AC Coupled

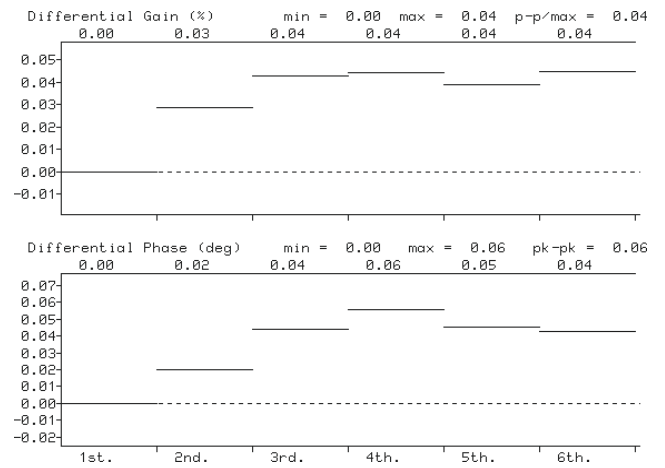



## Application Information

### General Description

The CLC1007, CLC2007, and CLC4007 are single supply, general purpose, voltage-feedback amplifiers fabricated on a complementary bipolar process using a patent pending topography. They feature a rail-to-rail output stage and are unity gain stable.

The common mode input range extends to 300mV below ground and to 0.9V below  $V_s$ . Exceeding these values will not cause phase reversal. However, if the input voltage exceeds the rails by more than 0.5V, the input ESD devices will begin to conduct. The output will stay at the rail during this overdrive condition.

The output stage is short circuit protected and offers "soft" saturation protection that improves recovery time.

Figures 1, 2, and 3 illustrate typical circuit configurations for non-inverting, inverting, and unity gain topologies for dual supply applications. They show the recommended bypass capacitor values and overall closed loop gain equations. Figure 4 shows the typical non-inverting gain circuit for single supply applications.

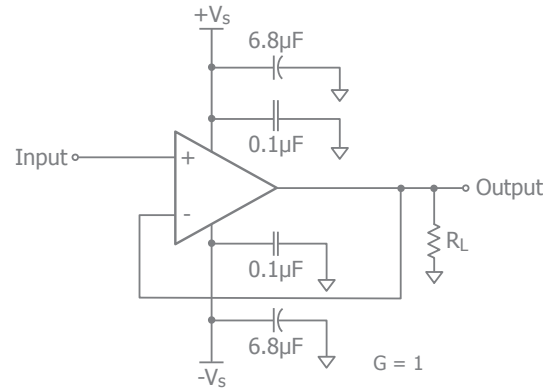

Figure 3. Unity Gain Circuit

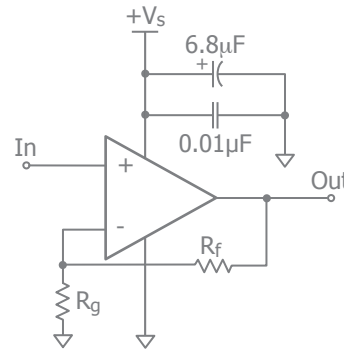

Figure 4. Single Supply Non-Inverting Gain Circuit

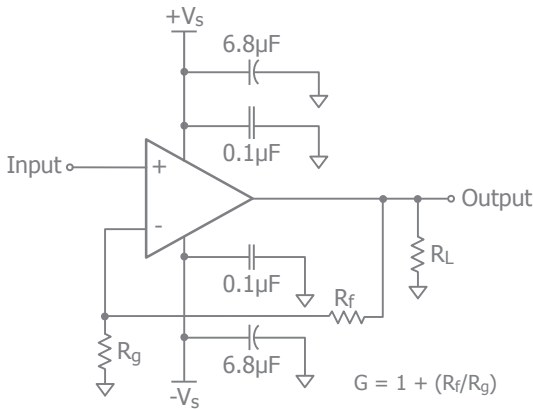

Figure 1. Typical Non-Inverting Gain Circuit

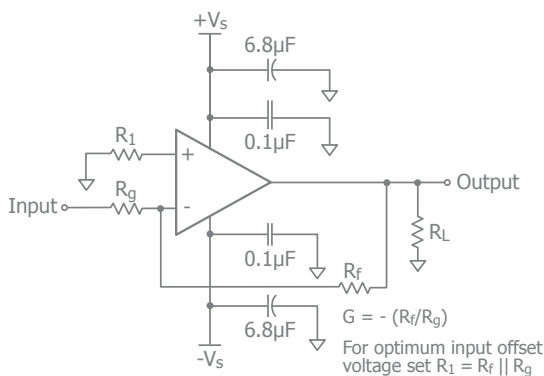

Figure 2. Typical Inverting Gain Circuit

### Overdrive Recovery

For an amplifier, an overdrive condition occurs when the output and/or input ranges are exceeded. The recovery time varies based on whether the input or output is overdriven and by how much the ranges are exceeded. The CLC1007, CLC2007, and CLC4007 will typically recover in less than 20ns from an overdrive condition. Figure 5 shows the CLC2007 in an overdriven condition.

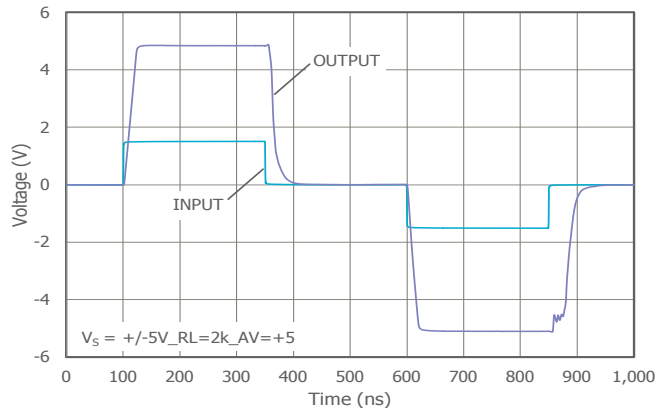

Figure 5: Overdrive Recovery



## Power Dissipation

Power dissipation should not be a factor when operating under the stated 2kΩ load condition. However, applications with low impedance, DC coupled loads should be analyzed to ensure that maximum allowed junction temperature is not exceeded. Guidelines listed below can be used to verify that the particular application will not cause the device to operate beyond its intended operating range.

Maximum power levels are set by the absolute maximum junction rating of 170°C. To calculate the junction temperature, the package thermal resistance value  $\Theta_{JA}$  ( $\Theta_{JA}$ ) is used along with the total die power dissipation.

$$T_{\text{Junction}} = T_{\text{Ambient}} + (\Theta_{JA} \times P_D)$$

Where  $T_{\text{Ambient}}$  is the temperature of the working environment.

In order to determine  $P_D$ , the power dissipated in the load needs to be subtracted from the total power delivered by the supplies.

$$P_D = P_{\text{supply}} - P_{\text{load}}$$

Supply power is calculated by the standard power equation.

$$P_{\text{supply}} = V_{\text{supply}} \times I_{\text{RMS supply}}$$

$$V_{\text{supply}} = V_{S+} - V_{S-}$$

Power delivered to a purely resistive load is:

$$P_{\text{load}} = ((V_{\text{LOAD}})_{\text{RMS}})^2 / R_{\text{load eff}}$$

The effective load resistor ( $R_{\text{load eff}}$ ) will need to include the effect of the feedback network. For instance,

$R_{\text{load eff}}$  in Figure 3 would be calculated as:

$$R_L \parallel (R_f + R_g)$$

These measurements are basic and are relatively easy to perform with standard lab equipment. For design purposes however, prior knowledge of actual signal levels and load impedance is needed to determine the dissipated power. Here,  $P_D$  can be found from

$$P_D = P_{\text{Quiescent}} + P_{\text{Dynamic}} - P_{\text{Load}}$$

Quiescent power can be derived from the specified  $I_S$  values along with known supply voltage,  $V_{\text{Supply}}$ . Load power can be calculated as above with the desired signal

amplitudes using:

$$(V_{\text{LOAD}})_{\text{RMS}} = V_{\text{PEAK}} / \sqrt{2}$$

$$(I_{\text{LOAD}})_{\text{RMS}} = (V_{\text{LOAD}})_{\text{RMS}} / R_{\text{load eff}}$$

The dynamic power is focused primarily within the output stage driving the load. This value can be calculated as:

$$P_{\text{DYNAMIC}} = (V_{S+} - V_{\text{LOAD}})_{\text{RMS}} \times (I_{\text{LOAD}})_{\text{RMS}}$$

Assuming the load is referenced in the middle of the power rails or  $V_{\text{supply}}/2$ .

The CLC1007 is short circuit protected. However, this may not guarantee that the maximum junction temperature (+150°C) is not exceeded under all conditions. Figure 6 shows the maximum safe power dissipation in the package vs. the ambient temperature for the packages available.

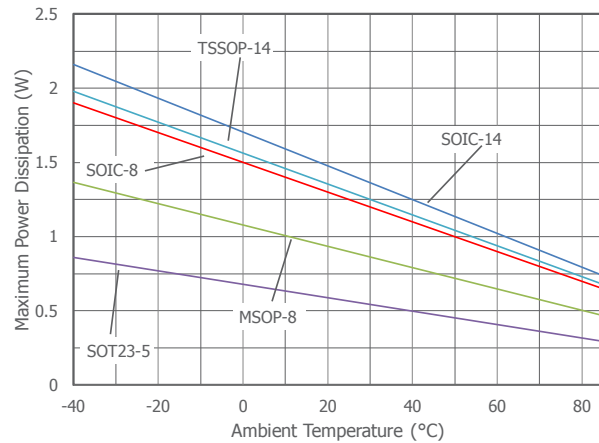

Figure 6. Maximum Power Derating

## Driving Capacitive Loads

Increased phase delay at the output due to capacitive loading can cause ringing, peaking in the frequency response, and possible unstable behavior. Use a series resistance,  $R_S$ , between the amplifier and the load to help improve stability and settling performance. Refer to Figure 7.

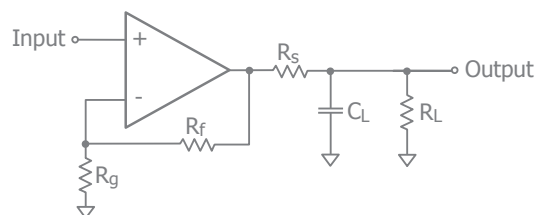



Figure 7. Addition of  $R_S$  for Driving Capacitive Loads

Table 1 provides the recommended  $R_S$  for various capacitive loads. The recommended  $R_S$  values result in approximately <1dB peaking in the frequency response.

CL (Pf)	$R_S$ ( $\Omega$ )	-3db BW (MHz)
22pF	0	118
47pF	15	112
100pF	15	91
492pF	6.5	59

Table 1: Recommended  $R_S$  vs.  $C_L$

For a given load capacitance, adjust  $R_S$  to optimize the tradeoff between settling time and bandwidth. In general, reducing  $R_S$  will increase bandwidth at the expense of additional overshoot and ringing.

**Layout Considerations**

General layout and supply bypassing play major roles in high frequency performance. CADEKA has evaluation boards to use as a guide for high frequency layout and as an aid in device testing and characterization. Follow the steps below as a basis for high frequency layout:

- Include 6.8 $\mu$ F and 0.1 $\mu$ F ceramic capacitors for power supply decoupling
- Place the 6.8 $\mu$ F capacitor within 0.75 inches of the power pin
- Place the 0.1 $\mu$ F capacitor within 0.1 inches of the power pin
- Remove the ground plane under and around the part, especially near the input and output pins to reduce parasitic capacitance
- Minimize all trace lengths to reduce series inductances

Refer to the evaluation board layouts below for more information.

**Evaluation Board Information**

The following evaluation boards are available to aid in the testing and layout of these devices:

Evaluation Board	Products
CEB003	CLC1007 in SOIC
CEB006	CLC2007 in SOIC
CEB010	CLC2007 in MSOP
CEB018	CLC4007 in SOIC

**Evaluation Board Schematics**

Evaluation board schematics and layouts are shown in Figures 10-18. These evaluation boards are built for dual-supply operation. Follow these steps to use the board in a single-supply application:

1. Short -Vs to ground.
2. Use C3 and C4, if the -Vs pin of the amplifier is not directly connected to the ground plane.

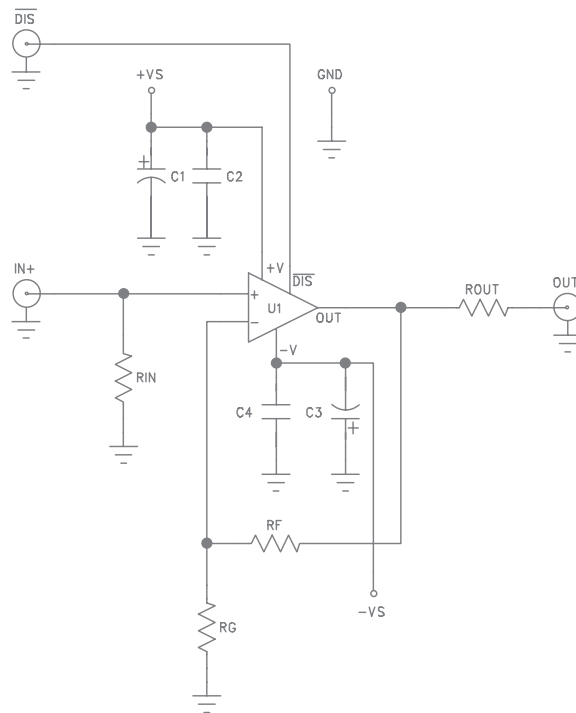

Figure 8. CEB002 & CEB003 Schematic

Evaluation Board	Products
CEB002	CLC1007 in TSOT-5

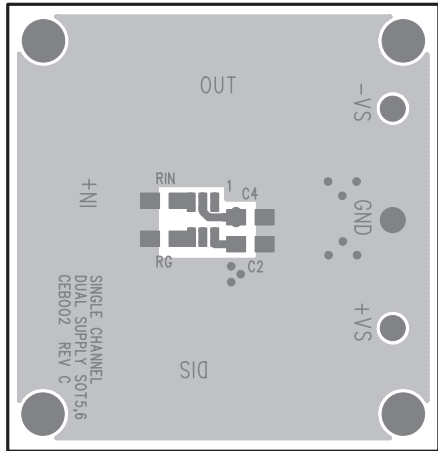

Figure 9. CEB002 Top View

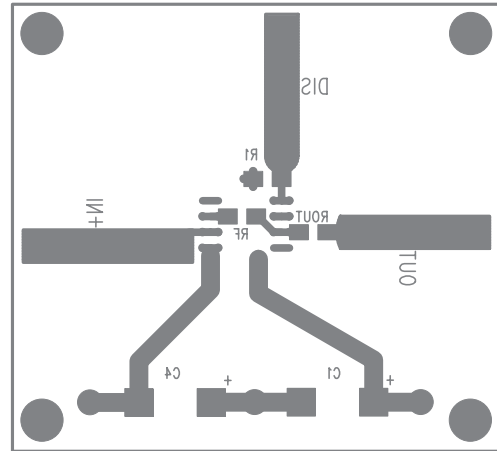

Figure 12. CEB003 Bottom View

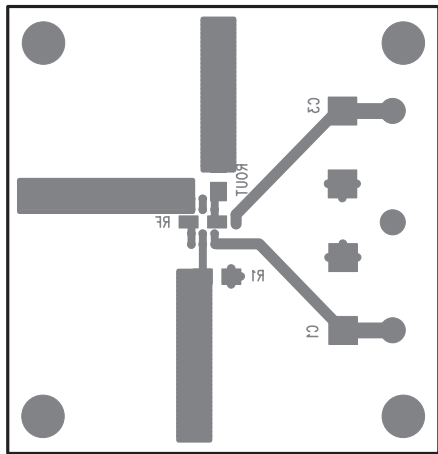

Figure 10. CEB002 Bottom View

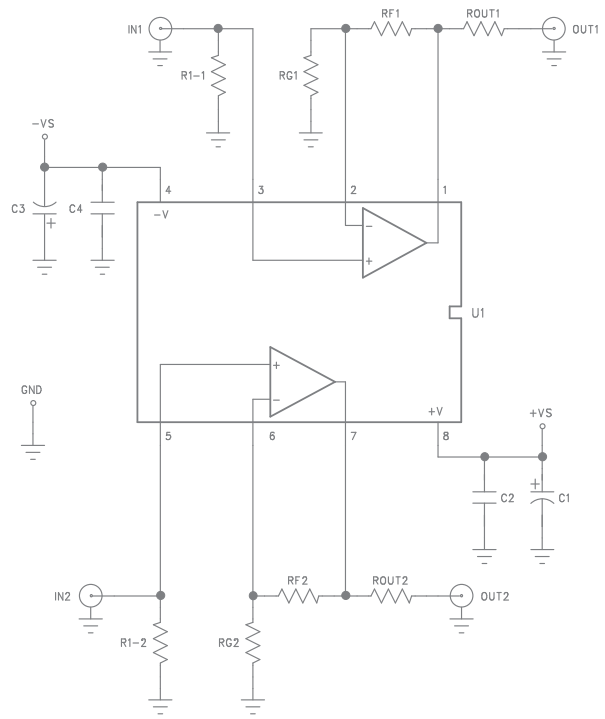

Figure 13. CEB006 & CEB010 Schematic

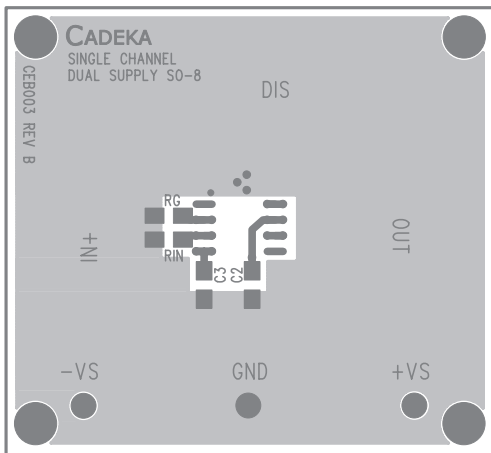

Figure 11. CEB003 Top View

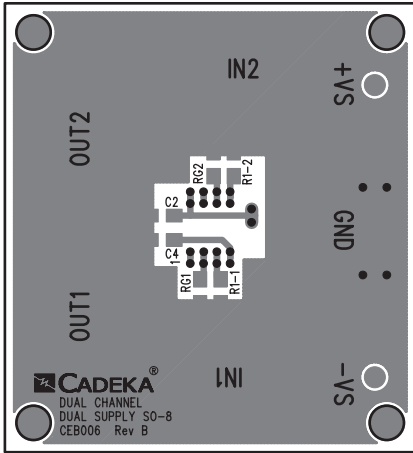
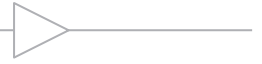

Figure 14. CEB006 Top View

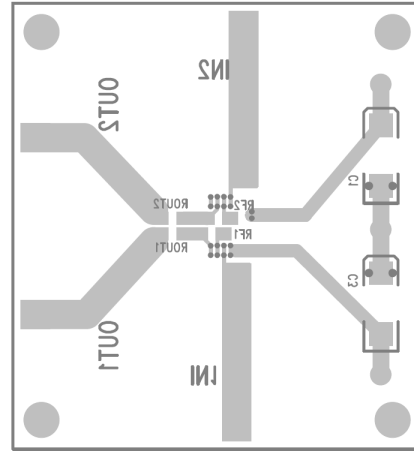

Figure 17. CEB010 Bottom View

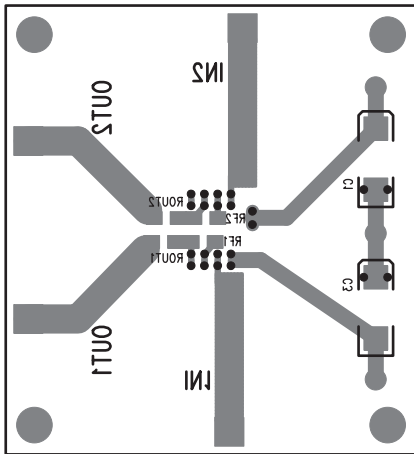

Figure 15. CEB006 Bottom View

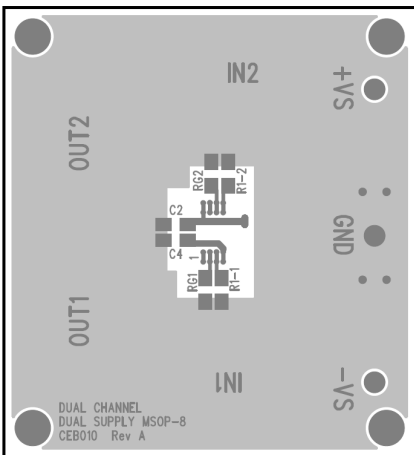

Figure 16. CEB010 Top View

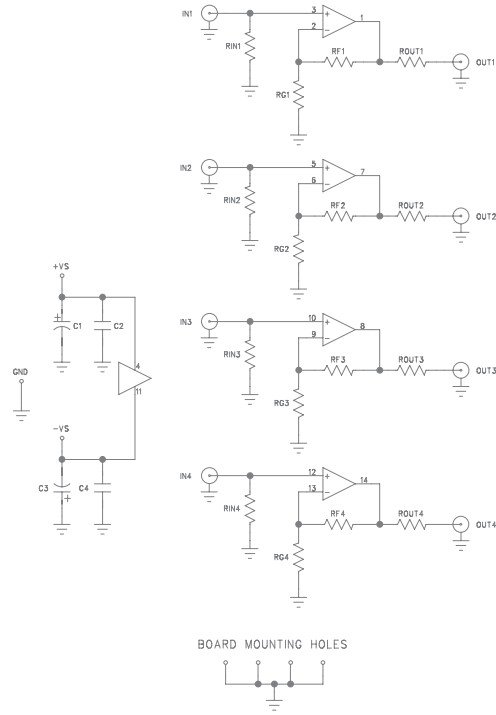

Figure 18. CEB018 Schematic

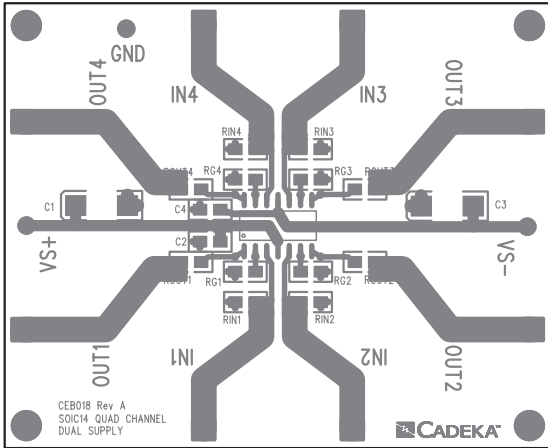
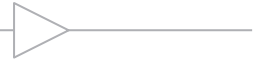

Figure 19. CEB018 Top View

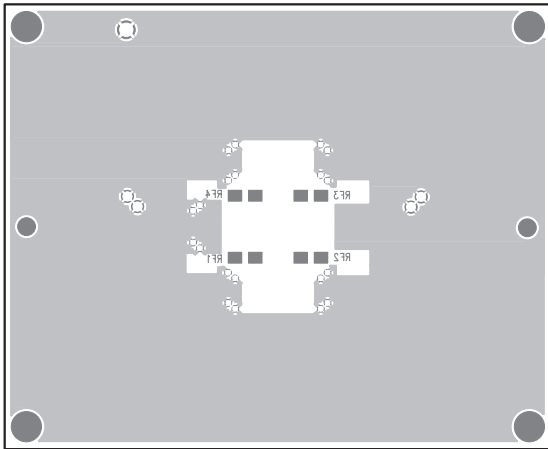
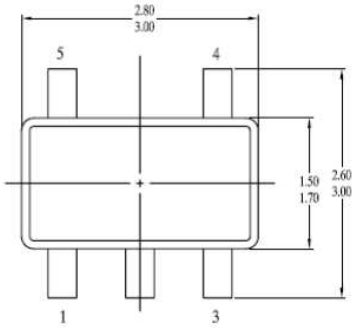

Figure 20. CEB018 Bottom View



## Mechanical Dimensions continued

### TSOT-5 Package



TOP VIEW

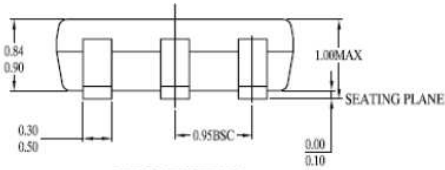

FRONT VIEW

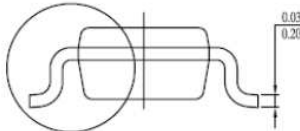

SEE DETAIL "A"

SIDE VIEW

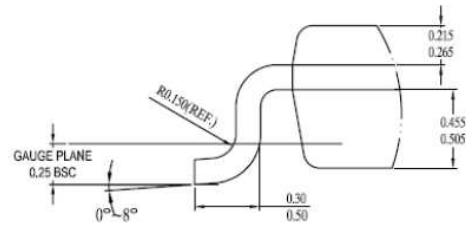

DETAIL "A"

**NOTE:**

1. ALL DIMENSIONS ARE IN MILLIMETERS.
2. PACKAGE LENGTH DOES NOT INCLUDE INTERLEAD FLASH OR PROTRUSION
3. PACKAGE WIDTH DOES NOT INCLUDE INTERLEAD FLASH OR PROTRUSION.
4. LEAD COPLANARITY (BOTTOM OF LEADS AFTER FORMING) SHALL BE 0.10 MILLIMETERS MAX.
5. DRAWING CONFORMS TO JEDEC MO-193, VARIATION AA.
6. DRAWING IS NOT TO SCALE.

### SOIC-8 Package

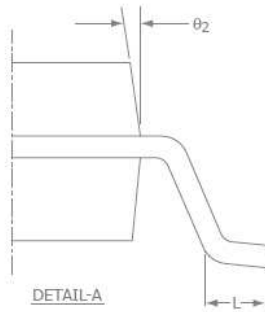
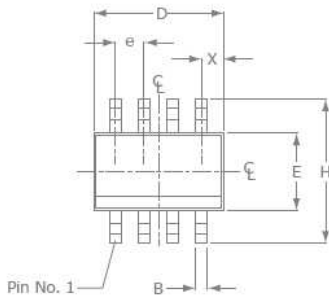

DETAIL-A

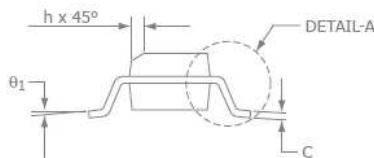
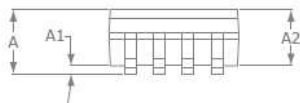

SOIC-8		
SYMBOL	MIN	MAX
A1	0.10	0.25
B	0.36	0.48
C	0.19	0.25
D	4.80	4.98
E	3.81	3.99
e	1.27 BSC	
H	5.80	6.20
h	0.25	0.5
L	0.41	1.27
A	1.37	1.73
θ <sub>1</sub>	0°	8°
X	0.55 ref	
θ <sub>2</sub>	7° BSC	

**NOTE:**

1. All dimensions are in millimeters.
2. Lead coplanarity should be 0 to 0.1mm (0.004") max.
3. Package surface finishing: VDI 24~27
4. All dimension excluding mold flashes.
5. The lead width, B to be determined at 0.1905mm from the lead tip.



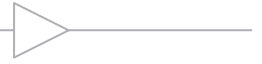

## Mechanical Dimensions continued

### TSSOP-14 Package

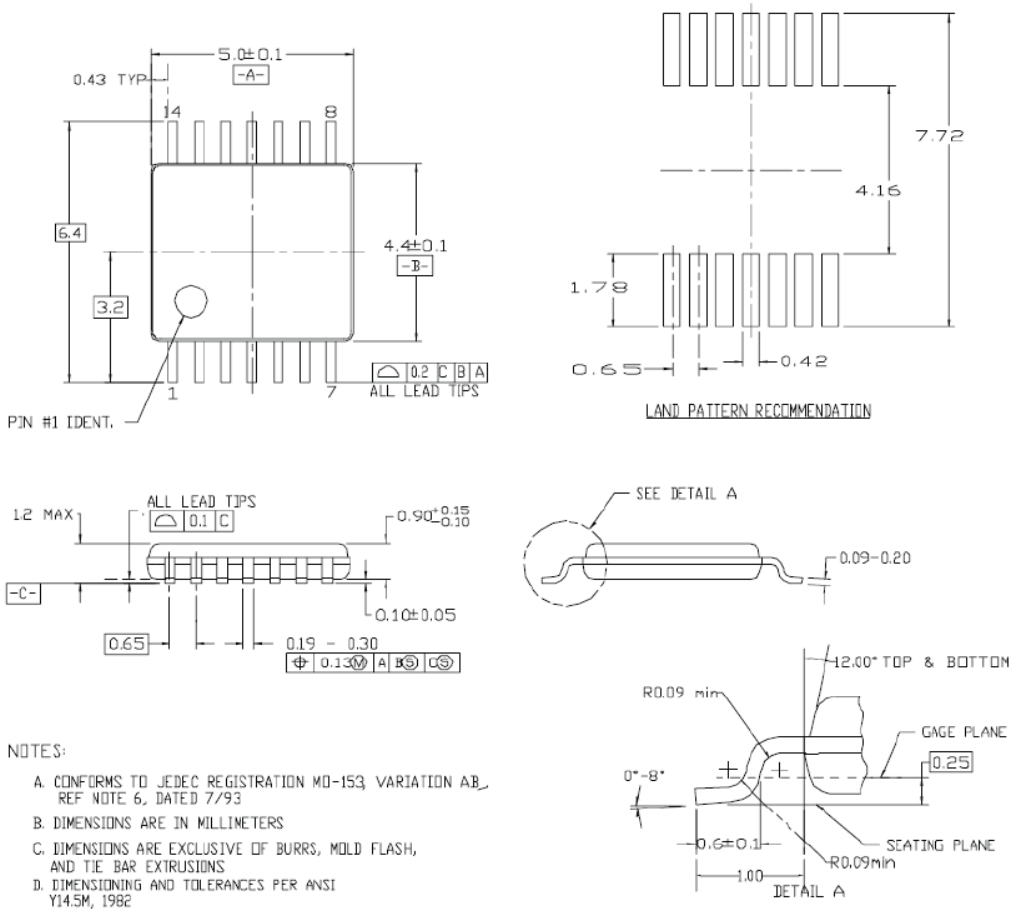

- NOTES:
- A. CONFORMS TO JEDEC REGISTRATION MO-153 VARIATION AB, REF NOTE 6, DATED 7/93
  - B. DIMENSIONS ARE IN MILLIMETERS
  - C. DIMENSIONS ARE EXCLUSIVE OF BURRS, MOLD FLASH, AND TIE BAR EXTRUSIONS
  - D. DIMENSIONING AND TOLERANCES PER ANSI Y14.5M, 1982

Comlinear CLC1007, CLC2007, CLC4007 Rev - 1

For additional information regarding our products, please visit CADEKA at: [cadeka.com](http://cadeka.com)

**CADEKA Headquarters** Loveland, Colorado  
 T: 970.663.5452  
 T: 877.663.5452 (toll free)



CADEKA, the CADEKA logo design, Comlinear, and the Comlinear logo design are trademarks or registered trademarks of CADEKA Microcircuits LLC. All other brand and product names may be trademarks of their respective companies.

CADEKA reserves the right to make changes to any products and services herein at any time without notice. CADEKA does not assume any responsibility or liability arising out of the application or use of any product or service described herein, except as expressly agreed to in writing by CADEKA; nor does the purchase, lease, or use of a product or service from CADEKA convey a license under any patent rights, copyrights, trademark rights, or any other of the intellectual property rights of CADEKA or of third parties.

Copyright ©2007-2010 by CADEKA Microcircuits LLC. All rights reserved.