

MODEL NUMBER DPS45081

Phase Shifter 4 Section

FEATURES

- 70 MHz
- 1.4° LSB
- Surface Mount
- 2.4 dB Insertion Loss

4 BIT

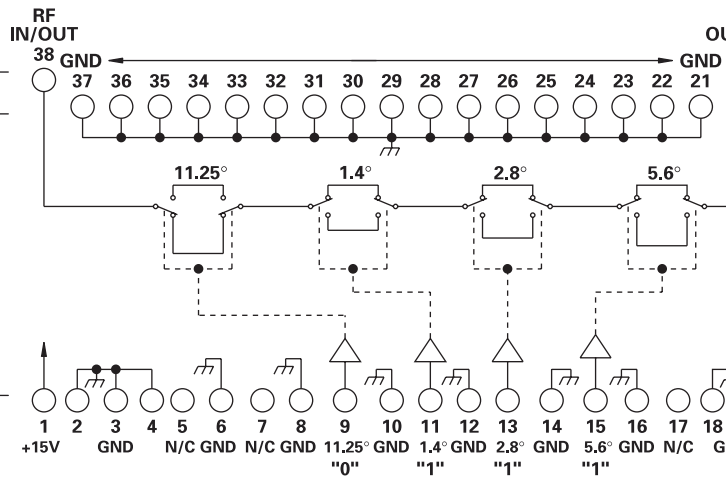
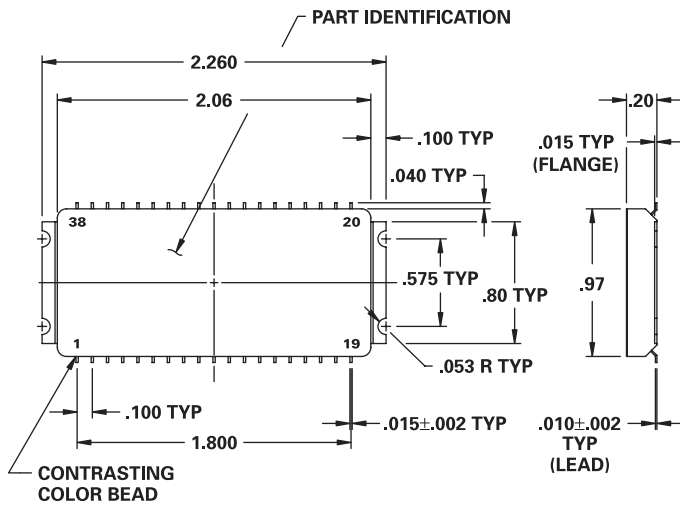

GUARANTEED PERFORMANCE

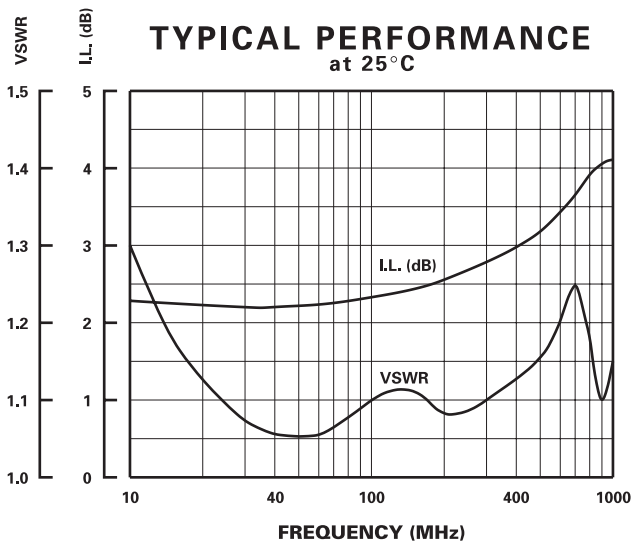

Parameter	Min	Typ	Max	Units	Conditions
Operating Frequency		70		MHz	
DC Current		14	50	mA	At +15 VDC Supply
Control Type		TTL			4 Line Logic "0" = Thru Logic "1" = Phase
Control Current	High Low	0.03 0.03	±10 ±10	µA	V _{IH} = +2.7 V V _{IL} = +0.5 V
Insertion Loss		2.4	3.5	dB	
Phase	LSB Range Accuracy	0	1.4 21.0 ±1	DEG DEG DEG	1.4, 2.8, 5.6, 11.25 DEG
VSWR		1.1/1	1.5/1		
Impedance		50		OHMS	
Switching Speed		8.0	20	µSec	50% TTL to 90% / 10% R
Transition (Rise/Fall) Time		1.0		µSec	10% / 90% or 90% / 10%
Switching (Video) Transients		26		mV	Peak Value
Intercept Points	2nd 3rd	+53 +25		dBm dBm	
RF Power	Operate No Damage	+22 +30	+10 +30	dBm dBm	0.1 dB Compression
Operating Temperature		+14	+25 +36	°C	TA