

**MODEL NUMBER  
DS0966-1**

**PIN Diode SP2T**

**FEATURES**

- 20-2000 MHz
- Very Low Insertion Loss
- High Insertion Points
- Non-Reflective
- 14 Pin DIP

**SP2T**

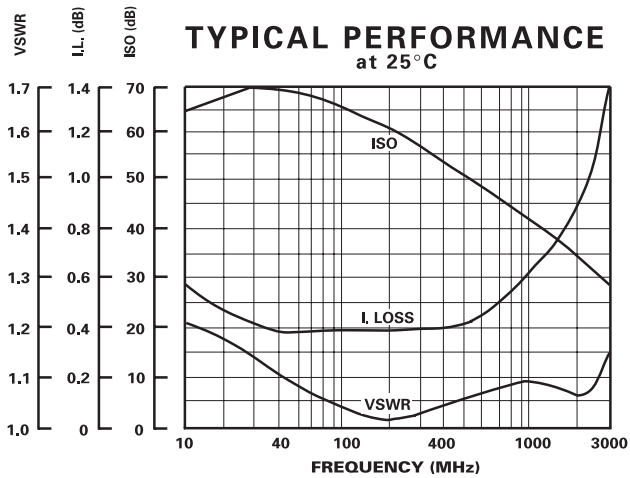
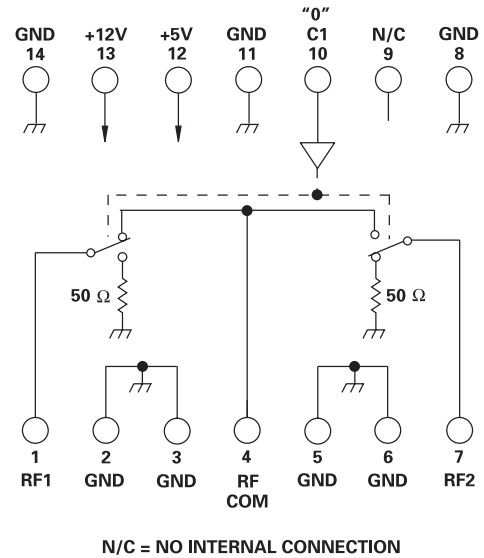
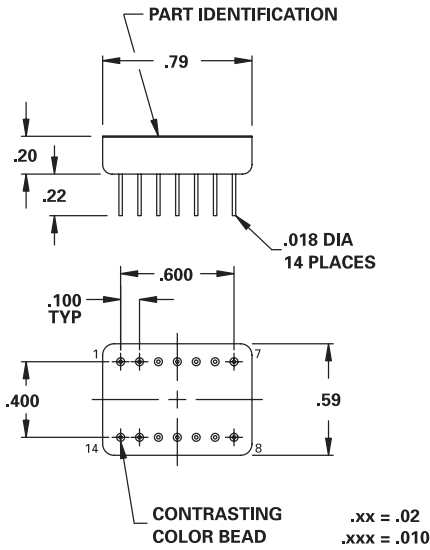

**GUARANTEED PERFORMANCE**

Parameter	Min	Typ	Max	Units	Conditions
Operating Frequency	20		2000	MHz	
DC Current		19	30	mA	At +5 VDC Supply
		6.5	10	mA	At +12 VDC Supply
Control Type		TTL			1 Line Logic "0" = RF COM to RF 1 Logic "1" = RF COM to RF 2
Control Current	High	0	+20	μA	V <sub>IH</sub> = +2.7V
	Low	0	+20	μA	V <sub>IL</sub> = +0.5V
Insertion Loss		0.44	0.5	dB	20 - 500 MHz
		0.65	0.8	dB	500 - 1000 MHz
		0.90	1.1	dB	1000 - 2000 MHz
Isolation	43	50		dB	20 - 500 MHz
	35	43		dB	500 - 1000 MHz
	28	35		dB	1000 - 2000 MHz
VSWR	Thru	1.16/1	1.3/1		
	Termination	1.18/1	1.3/1		
Impedance		50		OHMS	
Switching Speed		1.4	5	μSEC	50% TTL to 90% / 10% RF
Transition (Rise/Fall) Time		0.7		μSEC	90% / 10% or 10% / 90%
Switching (Video) Transients		1.8		V	Peak Value
Intercept Points	2nd	+84		dBm	214 MHz / 127 MHz Inputs
	3rd	+56		dBm	107 MHz / 127 MHz Inputs
RF Power	Operate	+29	+25	dBm	0.1 dB Compression
	No Damage		+30	dBm	
Operating Temperature	0	+25	+54	°C	TA