

Features and Benefits (continued)

- external filter components
- Built-in Bias Assist function enables stable startup operation
- V_{CC} operational range expanded
- Internal power MOSFET is avalanche energy guaranteed; two-chip structure

- Protection functions
 - Overcurrent protection (OCP): pulse by pulse basis, low dependence on input voltage
 - Overload protection (OLP): latched shutoff*
 - Overvoltage protection (OVP): latched shutoff*
 - Maximum on-time limitation
 - Thermal shutdown protection (TSD): latched shutoff*

*Latched shutoff means the output is kept in a shutoff mode for protection, until reset.

Selection Guide

Part Number	$V_{DSS}(\text{min})$ (V)	$R_{DS(\text{on})}(\text{max})$ (Ω)	Package	Packing
STR-Y6753	650	1.9	TO-220F	50 pieces per tube
STR-Y6754		1.4		

Absolute Maximum Ratings Unless specifically noted, $T_A = 25^\circ\text{C}$ and $V_{CC} = 20\text{ V}$

Characteristic	Symbol	Notes	Pins	Rating	Unit
Drain Current ¹	I_{DPEAK}	STR-Y6753	1 – 2	9.2	A
		STR-Y6754		11.0	A
Maximum Switching Current	I_{DMAX}	STR-Y6753	1 – 2	9.2	A
		STR-Y6754		11.0	A
Single Pulse Avalanche Energy ²	E_{AS}	STR-Y6753	1 – 2	99	mJ
		STR-Y6754		198	mJ
Input Voltage in Control Part (MIC)	V_{CC}		3 – 4	35	V
Startup (D/ST) Pin Voltage	$V_{STARTUP}$		1 – 4	-1.0 to V_{DSS}	V
OCP Pin Voltage	V_{OCP}		2 – 4	-2.0 to 6.0	V
FB Pin Voltage	V_{FB}		5 – 4	-0.3 to 7.0	V
FB Pin Sink Current ³	I_{FB}		5 – 4	10.0	mA
BD Pin Voltage	V_{BD}		6 – 4	-6.0 to 6.0	V
Power Dissipation in MOSFET ⁴	P_{D1}	STR-Y6753	1 – 2	20.2	W
		STR-Y6754		21.5	W
		Without heatsink		1.8	W
Power Dissipation in Control Part (MIC)	P_{D2}		–	0.8	W
Internal Frame Temperature in Operation	T_F	Recommended internal frame temperature is $T_F = 105^\circ\text{C}$ (max).	–	-20 to 115	$^\circ\text{C}$
Operating Ambient Temperature	T_{OP}		–	-20 to 115	$^\circ\text{C}$
Storage Temperature	T_{stg}		–	-40 to 125	$^\circ\text{C}$
Channel Temperature	T_{ch}		–	150	$^\circ\text{C}$

¹Refer to MOSFET Safe Operating Area Curve.

²Refer to MOSFET Avalanche Energy Derating Coefficient Curve.

³The polarity value for current specifies a sink as "+," and a source as "-," referencing the IC.

⁴Refer to MOSFET Temperature versus Power Dissipation Curve.

Functional Block Diagram

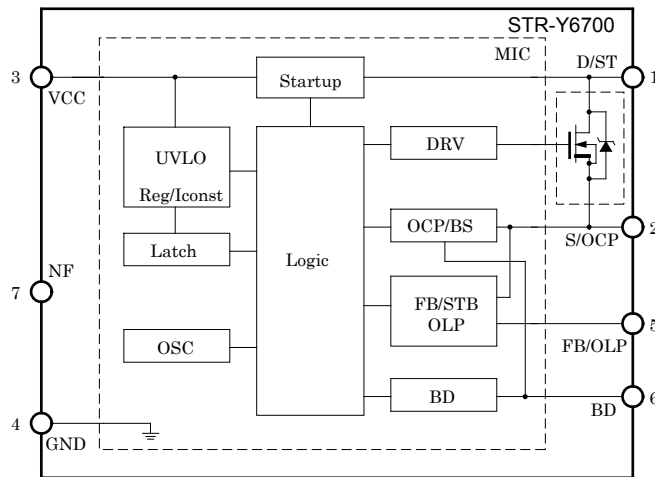

Pin List Table

Name	Number	Function
1	D/ST	MOSFET drain and Startup circuit input
2	S/OCP	MOSFET source and overcurrent detection signal input
3	VCC	Control circuit power supply input
4	GND	Ground
5	FB/OLP	Constant Voltage Control signal input, Standby control, and overload detection signal input
6	BD	Bottom Detection signal input, Input Compensation detection signal input
7	NF	For stable operation, connect to GND pin, using the shortest possible path

All performance characteristics given are typical values for circuit or system baseline design only and are at the nominal operating voltage and an ambient temperature, T_A , of 25°C, unless otherwise stated.

Electrical Characteristics of Control Part (MIC) Unless specifically noted, $T_A = 25^\circ\text{C}$ and $V_{CC} = 20\text{ V}$

Characteristic	Symbol	Test Conditions	Pins	Min.	Typ.	Max.	Unit
Power Supply Startup Operation							
Operation Start Voltage	$V_{CC(ON)}$		3 – 4	13.8	15.1	17.3	V
Operation Stop Voltage ¹	$V_{CC(OFF)}$		3 – 4	8.4	9.4	10.7	V
Circuit Current in Operation	$I_{CC(ON)}$		3 – 4	–	1.3	3.7	mA
Circuit Current in Non-Operation	$I_{CC(OFF)}$	$V_{CC} = 13\text{ V}$	3 – 4	–	4.5	50	μA
Startup Circuit Operation Voltage	$V_{START(ON)}$		1 – 4	42	57	72	V
Startup Current	$I_{CC(STARTUP)}$	$V_{CC} = 13\text{ V}$	3 – 4	-4.5	-3.1	-1.0	mA
Startup Current Supply Threshold Voltage ¹	$V_{CC(BIAS)}$		3 – 4	9.5	11.0	12.5	V
Operation Frequency	f_{OSC}		1 – 4	18.4	21.0	24.4	kHz
Soft Start Operation Duration	t_{SS}		1 – 4	–	6.05	–	ms
Normal Operation							
Bottom-Skip Operation Threshold Voltage 1	$V_{OCP(BS1)}$		2 – 4	0.487	0.572	0.665	V
Bottom-Skip Operation Threshold Voltage 2	$V_{OCP(BS2)}$		2 – 4	0.200	0.289	0.380	V
Quasi-Resonant Operation Threshold Voltage 1 ²	$V_{BD(TH1)}$		6 – 4	0.14	0.24	0.34	V
Quasi-Resonant Operation Threshold Voltage 2 ²	$V_{BD(TH2)}$		6 – 4	–	0.17	–	V
Maximum Feedback Current	$I_{FB(MAX)}$		5 – 4	-320	-205	-120	μA
Stand-by Operation							
Standby Operation Threshold Voltage	$V_{FB(STBOP)}$		5 – 4	0.45	0.80	1.15	V
Protected Operation							
Maximum On-Time	$t_{ON(MAX)}$		1 – 4	30.0	40.0	50.0	μs
Leading Edge Blanking Time	$t_{ON(LEB)}$	STR-Y6753	1 – 4	–	470	–	ns
		STR-Y6754		–	455	–	ns
Overcurrent Detection Threshold Voltage (Normal Operation)	$V_{OCP(H)}$	$V_{BD} = 0\text{ V}$	2 – 4	0.820	0.910	1.000	V
Overcurrent Detection Threshold Voltage (Input Compensation in Operation)	$V_{OCP(L)}$	$V_{BD} = -3\text{ V}$	2 – 4	0.560	0.660	0.760	V
Overcurrent Detection Threshold Voltage (Latched shutoff) ³	$V_{OCP(La.OFF)}$		2 – 4	1.65	1.83	2.01	V

Continued on the next page...

Electrical Characteristics of Control Part (MIC) (Continued) Unless specifically noted, $T_A = 25^\circ\text{C}$ and $V_{CC} = 20\text{ V}$

Characteristic	Symbol	Test Conditions	Pins	Min.	Typ.	Max.	Unit
BD Pin Source Current	$I_{BD(O)}$		6 – 4	-250	-83	-30	μA
OLP Bias Current	$I_{FB(OLP)}$		5 – 4	-15	-10	-5	μA
OLP Threshold Voltage	$V_{FB(OLP)}$		5 – 4	5.50	5.96	6.40	V
OVP Threshold Voltage	$V_{CC(OVP)}$		3 – 4	28.5	31.5	34.0	V
FB Pin Maximum Voltage in Feedback Operation	$V_{FB(MAX)}$		5 – 4	3.70	4.05	4.40	V
Thermal Shut Down Temperature	$T_{J(TSD)}$		–	135	–	–	$^\circ\text{C}$

Note: The polarity value for current specifies a sink as "+," and a source as "–," referencing the IC.

¹The relation of $V_{CC(BIAS)} > V_{CC(OFF)}$ is maintained.

²The relation of $V_{BD(TH1)} > V_{BD(TH2)}$ is maintained in each product.

²The latch circuit means a circuit operated OVP, OLP, OCP (latch-off), or TSD.

Electrical Characteristics of MOSFET Unless specifically noted, $T_A = 25^\circ\text{C}$ and $V_{CC} = 20\text{ V}$

Characteristic	Symbol	Test Conditions	Pins	Min.	Typ.	Max.	Unit
Voltage Between Drain and Source	V_{DSS}		1 – 2	650	–	–	V
Drain Leakage Current	I_{DSS}		1 – 2	–	–	300	μA
On-Resistance	$R_{DS(on)}$	STR-Y6753	1 – 2	–	–	1.9	Ω
		STR-Y6754	1 – 2	–	–	1.4	Ω
Switching Time	t_f	STR-Y6753	1 – 2	–	–	250	ns
		STR-Y6754	1 – 2	–	–	300	ns
Thermal Resistance	$R_{\theta ch-F}$	STR-Y6753	Between a channel of the MOSFET and the internal leadframe	–	–	2.7	$^\circ\text{C/W}$
		STR-Y6754		–	–	2.4	$^\circ\text{C/W}$

Characteristic Performance (STR-Y6753)

S. O. A. Temperature Derating Coefficient Curve

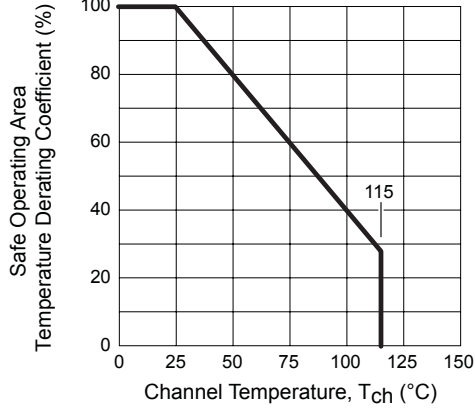

MOSFET Safe Operating Area Curve

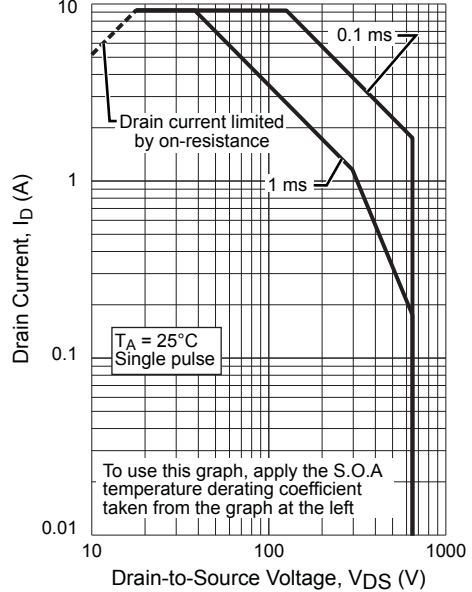

MOSFET Avalanche Energy Derating Coefficient Curve

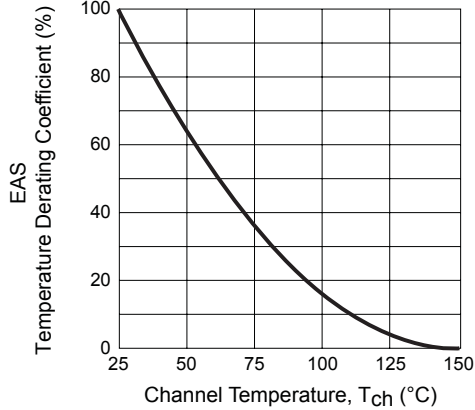

MOSFET Temperature versus Power Dissipation Curve

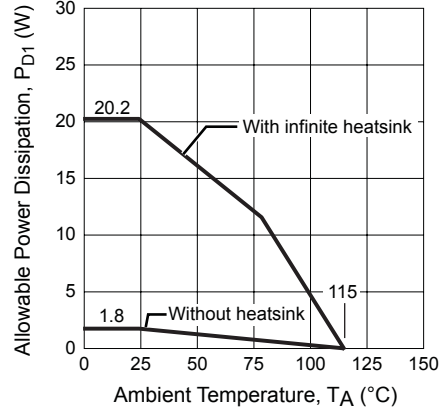

Transient Thermal Resistance Curve

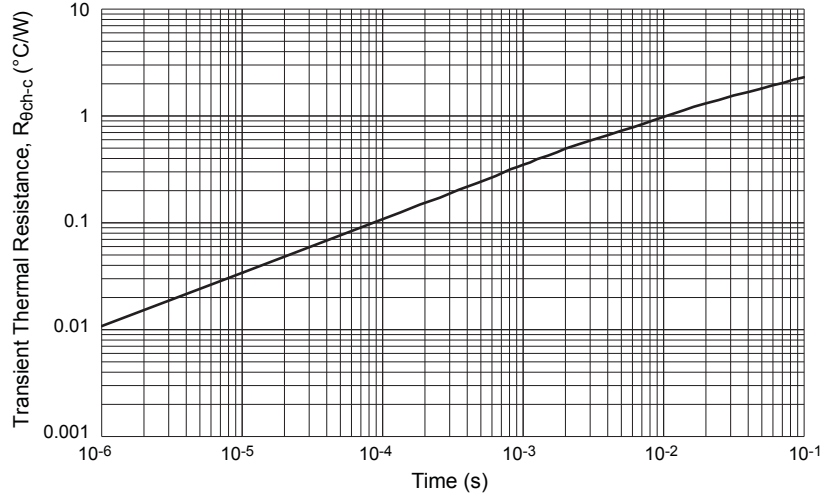

Characteristic Performance (STR-Y6754)

S. O. A. Temperature Derating Coefficient Curve

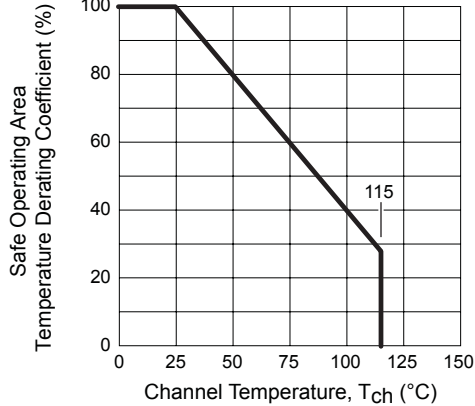

MOSFET Safe Operating Area Curve

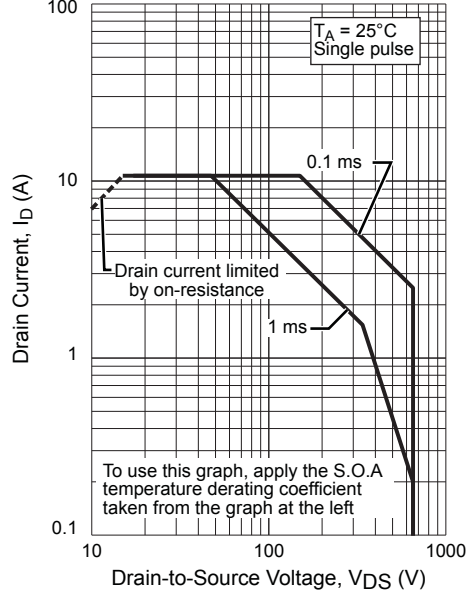

MOSFET Avalanche Energy Derating Coefficient Curve

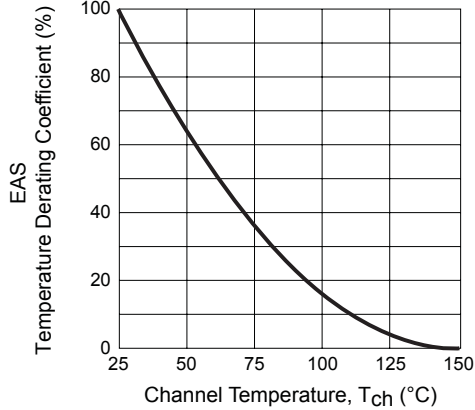

MOSFET Temperature versus Power Dissipation Curve

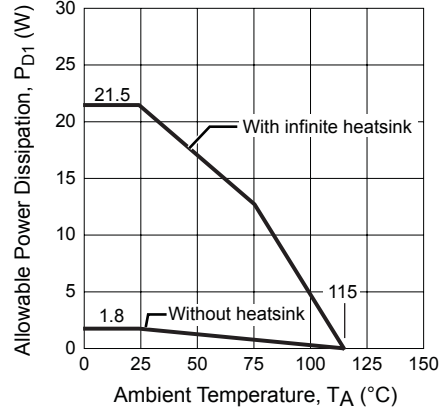

Transient Thermal Resistance Curve

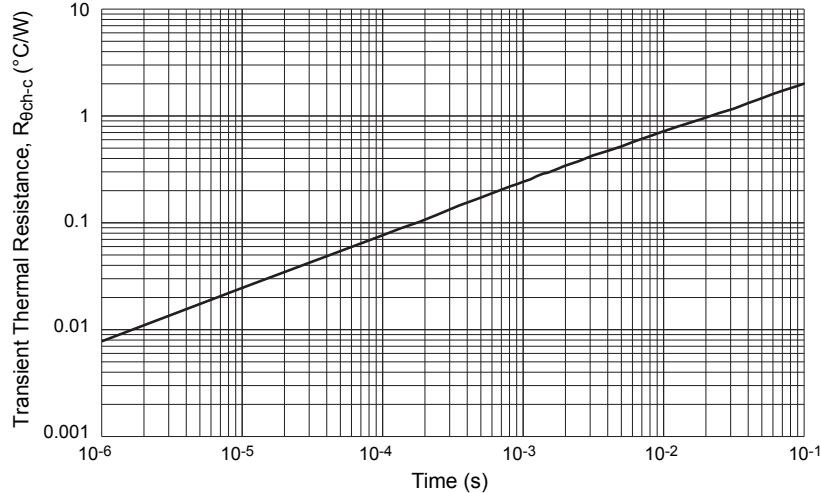

Package Outline Drawing

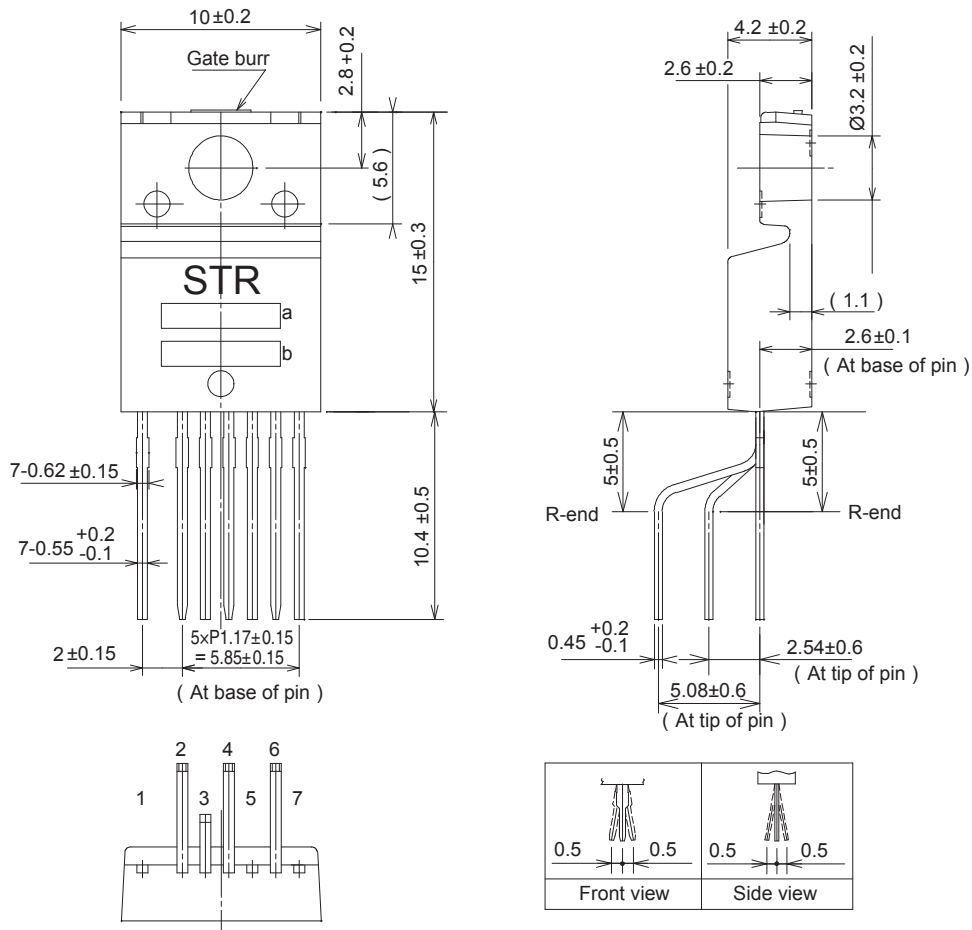

Unit: mm

Package: TO-220F

(Sanken leadform #3051)

Leadframe material: Cu

Pin treatment: Solder dip

Weight: Approximately 1.45 g

"Gate Burr" shows area where 0.3 mm (max) gate burr may be present

a: Part # Y6753 [or Y6754]

b: Lot number

1st letter: Last digit of year

2nd letter: Month

Jan to September: Numeric

October: O

November: N

December: D

3rd and 4th letter: Date

01 to 31: Numeric

5th letter: Internal use control number

Pin treatment Pb-free. Device composition compliant with the RoHS directive.

Packing Specifications

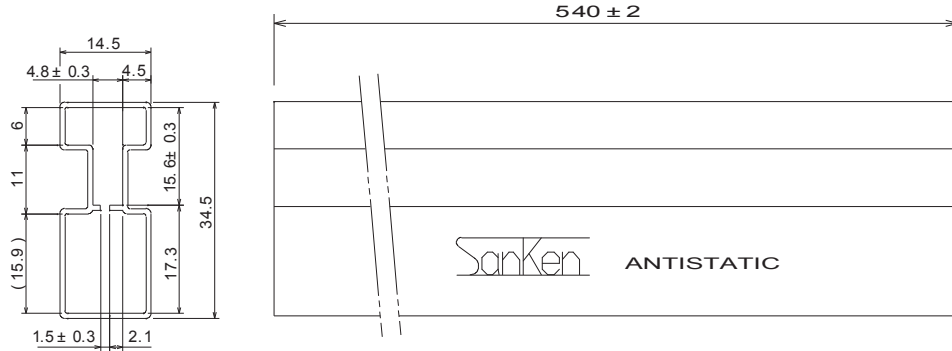

Tube dimensions (mm)
50 pieces per tube

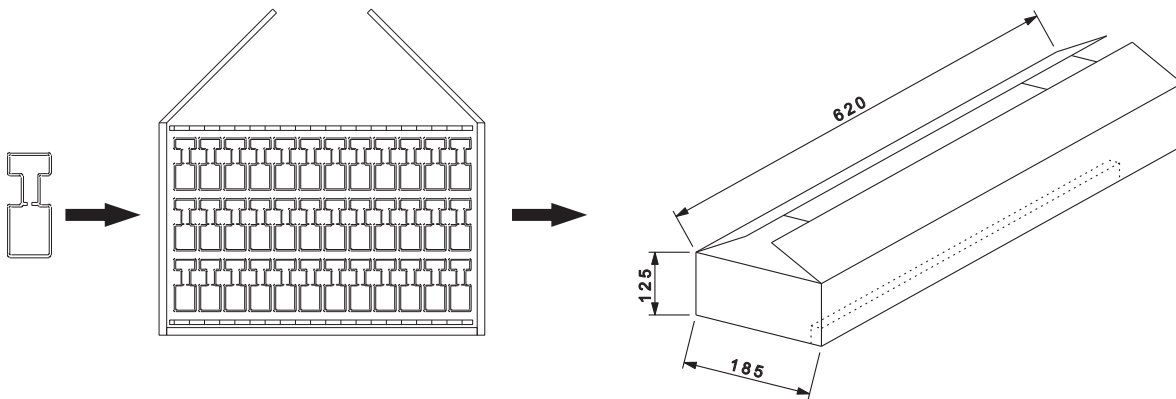

Carton dimensions (mm)

36 tubes per carton (maximum)
1800 pieces maximum per carton

Because reliability can be affected adversely by improper storage environments and handling methods, please observe the following cautions.

Cautions for Storage

- Ensure that storage conditions comply with the standard temperature (5°C to 35°C) and the standard relative humidity (around 40% to 75%); avoid storage locations that experience extreme changes in temperature or humidity.
- Avoid locations where dust or harmful gases are present and avoid direct sunlight.
- Reinspect for rust on leads and solderability of products that have been stored for a long time.

Cautions for Testing and Handling

When tests are carried out during inspection testing and other standard test periods, protect the products from power surges from the testing device, shorts between the product pins, and wrong connections.

Remarks About Using Silicone Grease with a Heatsink

- When silicone grease is used in mounting this product on a heatsink, it shall be applied evenly and thinly. If more silicone grease than required is applied, it may produce excess stress.
- Volatile-type silicone greases may crack after long periods of time, resulting in reduced heat radiation effect. Silicone grease with low consistency (hard grease) may cause cracks in the mold resin when screwing the product to a heatsink.
- Our recommended silicone greases for heat radiation purposes, which will not cause any adverse effect on the product life, are indicated below:

Type	Suppliers
G746	Shin-Etsu Chemical Co., Ltd.
YG6260	MOMENTIVE Performance Materials, Inc.
SC102	Dow Corning Toray Co., Ltd.

Heatsink Assembly

- Attachment torque should be in the range 0.588 to 0.785 N•m (6 to 8 kgf•cm).

Soldering

- The leadframe temperature should never exceed $T_F = 105^\circ\text{C}(\text{max})$.
- When soldering the products, please be sure to minimize the working time, within the following limits:
260±5°C 10 s
350±5°C 3 s (solder iron)
- Soldering iron should be at a distance of at least 2.0 mm from the body of the products.

Electrostatic Discharge

- When handling the products, the operator must be grounded. Grounded wrist straps worn should have at least 1 MΩ of resistance from the operator to ground to prevent shock hazard, and it should be placed near the operator.
- Workbenches where the products are handled should be grounded and be provided with conductive table and floor mats.
- When using measuring equipment such as a curve tracer, the equipment should be grounded.
- When soldering the products, the head of soldering irons or the solder bath must be grounded in order to prevent leak voltages generated by them from being applied to the products.
- The products should always be stored and transported in Sanken shipping containers or conductive containers, or be wrapped in aluminum foil.

-
- The contents in this document are subject to changes, for improvement and other purposes, without notice. Make sure that this is the latest revision of the document before use.
 - Application and operation examples described in this document are quoted for the sole purpose of reference for the use of the products herein and Sanken can assume no responsibility for any infringement of industrial property rights, intellectual property rights or any other rights of Sanken or any third party which may result from its use.
 - Although Sanken undertakes to enhance the quality and reliability of its products, the occurrence of failure and defect of semiconductor products at a certain rate is inevitable. Users of Sanken products are requested to take, at their own risk, preventative measures including safety design of the equipment or systems against any possible injury, death, fires or damages to the society due to device failure or malfunction.
 - Sanken products listed in this document are designed and intended for the use as components in general purpose electronic equipment or apparatus (home appliances, office equipment, telecommunication equipment, measuring equipment, etc.).
When considering the use of Sanken products in the applications where higher reliability is required (transportation equipment and its control systems, traffic signal control systems or equipment, fire/crime alarm systems, various safety devices, etc.), and whenever long life expectancy is required even in general purpose electronic equipment or apparatus, please contact your nearest Sanken sales representative to discuss, prior to the use of the products herein.
The use of Sanken products without the written consent of Sanken in the applications where extremely high reliability is required (aerospace equipment, nuclear power control systems, life support systems, etc.) is strictly prohibited.
 - In the case that you use our semiconductor devices or design your products by using our semiconductor devices, the reliability largely depends on the degree of derating to be made to the rated values. Derating may be interpreted as a case that an operation range is set by derating the load from each rated value or surge voltage or noise is considered for derating in order to assure or improve the reliability. In general, derating factors include electric stresses such as electric voltage, electric current, electric power etc., environmental stresses such as ambient temperature, humidity etc. and thermal stress caused due to self-heating of semiconductor devices. For these stresses, instantaneous values, maximum values and minimum values must be taken into consideration.
In addition, it should be noted that since power devices or IC's including power devices have large self-heating value, the degree of derating of junction temperature (T_j) affects the reliability significantly.
 - When using the products specified herein by either (i) combining other products or materials therewith or (ii) physically, chemically or otherwise processing or treating the products, please duly consider all possible risks that may result from all such uses in advance and proceed therewith at your own responsibility.
 - Anti radioactive ray design is not considered for the products listed herein.
 - Sanken assumes no responsibility for any troubles, such as dropping products caused during transportation out of Sanken's distribution network.
 - The contents in this document must not be transcribed or copied without Sanken's written consent.