

Powerex, Inc., 173 Pavilion Lane, Youngwood, Pennsylvania 15697 (724) 925-7272
www.pwr.com

**Phase Control SCR
1200 Amperes Average
4400 Volts**

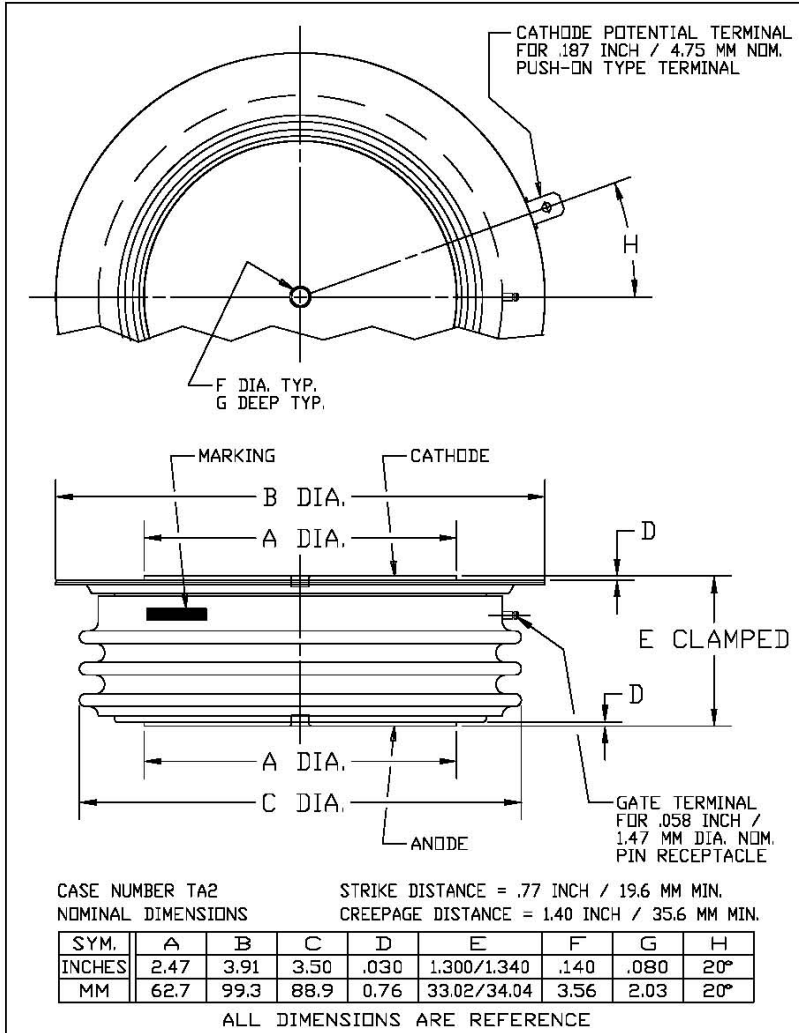

TAK7 120A (Outline Drawing)

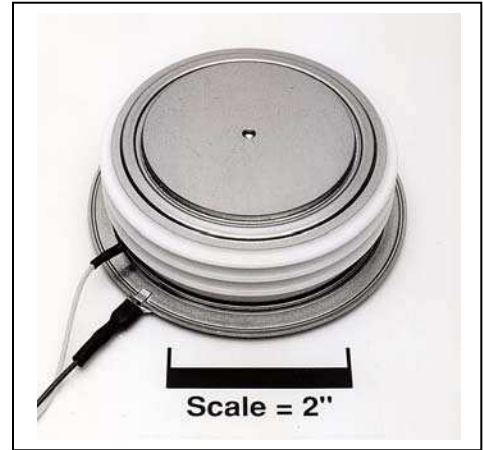

TAK7 1200A Phase Control SCR
1200 Amperes Average, 4400 Volts

Description:

Powerex Silicon Controlled Rectifiers (SCR) are designed for phase control applications. These are all-diffused, Press-Pak, hermetic Pow-R-Disc devices employing the field proven amplifying gate.

Features:

- Low On-State Voltage
- High di/dt Capability
- High dv/dt Capability
- Hermetic Packaging
- Excellent Surge and I²t Ratings

Applications:

- Power Supplies
- Battery Chargers
- Static VAR

Ordering Information:

Select the complete 12 digit module part number from the table below.
Example: TAK7441202DH is a 4400V 1200A Phase Control SCR.

Type	Voltage V _{RRM} (Volts)	Current I _{T(av)} (A)	Turn-off Time t _q (µsec)	Gate Current I _{GT} (mA)	Lead Code
TAK7	36 40 44	12	0	2	DH
	3600V 4000V 4400V	1200A	500 µsec (Typical)	300 mA	12"

Absolute Maximum Ratings

Characteristics	Symbol		Units
Non-Repetitive Transient Peak Reverse Blocking Voltage	V_{RSM}	$V_{RRM} + 100V$	Volts
RMS On-State Current, $T_C = 82^\circ C$	$I_{T(RMS)}$	1700	Amperes
Average Current 180° Sine Wave, $T_C = 82^\circ C$	$I_{T(AV)}$	1200	Amperes
RMS On-State Current, $T_C = 55^\circ C$	$I_{T(RMS)}$		Amperes
Average Current 180° Sine Wave, $T_C = 55^\circ C$	$I_{T(AV)}$	960	Amperes
Peak One Cycle Surge On-State Current (Non-Repetitive) 60 Hz	I_{TSM}	40,000	Amperes
Peak One Cycle Surge On-State Current (Non-Repetitive) 50 Hz	I_{TSM}	36,500	Amperes
Critical Rate-of-rise of On-State Current (Non-Repetitive)	di/dt	400	A/ μ sec
Critical Rate-of-rise of On-State Current (Repetitive)	di/dt	150	A/ μ sec
I^2t (for Fusing) for One Cycle, 60 Hz	I^2t	6.67×10^9	A ² sec
Peak Gate Power Dissipation	P_{GM}	16	Watts
Average Gate Power Dissipation	$P_{G(av)}$	3	Watts
Operating Temperature	T_J	-40 to +125	$^\circ C$
Storage Temperature	T_{stg}	-40 to +150	$^\circ C$
Approximate Weight		2.2	lb
		1000	g
Mounting Force		9000 to 11000	lb.
		4100 to 5000	kg.

Information presented is based upon manufacturers testing and projected capabilities.
This information is subject to change without notice.
The manufacturer makes no claim as to the suitability of use, reliability, capability,
or future availability of this product.

Electrical Characteristics, $T_J=25^\circ\text{C}$ unless otherwise specified

Characteristics	Symbol	Test Conditions	Min.	Typ.	Max.	Units
Repetitive Peak Reverse Leakage Current	I_{RRM}	$T_J=125^\circ\text{C}$, $V_R = V_{RRM}$			250	mA
Repetitive Peak Forward Leakage Current	I_{DRM}	$T_J=125^\circ\text{C}$, $V_D = V_{DRM}$			250	mA
Peak On-State Voltage	V_{TM}	$T_J=25^\circ\text{C}$, $I_{TM}=1500\text{A}$ peak, Duty Cycle < 0.1 %			1.90	V
Threshold Voltage, Low-level	$V_{(TO)1}$	$T_J = 125^\circ\text{C}$, $I_{TM} = 250\text{A}$ to 4000A			1.262	V
Slope Resistance, Low-level	r_{T1}				0.397	$\text{m}\Omega$
Threshold Voltage, High-level	$V_{(TO)2}$	$T_J = 125^\circ\text{C}$, $I_{TM} \geq 4000\text{A}$			1.412	V
Slope Resistance, High-level	r_{T2}				0.368	$\text{m}\Omega$
V_{TM} Coefficients		$T_J = 125^\circ\text{C}$		A =	2.53	
				B =	-0.294	
		$V_{TM} = A + B \ln(I) + C(I) + D \text{ Sqrt}(I)$		C =	2.47 E-04	
				D =	0.0284	
Typical Delay Time	t_d	$I_{TM} = 1000\text{A}$, $V_D = 1500\text{V}$		4		μs
Typical Turn-Off Time	t_q	$T_J = 125^\circ\text{C}$, $I_T = 250\text{A}$, $di_r/dt = 50\text{A}/\mu\text{s}$ Reapplied $dv/dt = 20\text{V}/\mu\text{s}$ Linear to 80% V_{DRM}		500		μs
Minimum Critical dv/dt – Exponential to V_{DRM}	dv/dt	$T_J = 125^\circ\text{C}$	1000			$\text{V}/\mu\text{s}$
Gate Trigger Current	I_{GT}	$T_J = 25^\circ\text{C}$, $V_D = 12\text{V}$			300	mA
Gate Trigger Voltage	V_{GT}	$T_J = 25^\circ\text{C}$, $V_D = 12\text{V}$			5.0	V
Non-Triggering Gate Voltage	V_{GDM}	$T_J = 125^\circ\text{C}$, $V_D = V_{DRM}$			0.45	V
Peak Forward Gate Current	I_{GTM}				4	A
Peak Reverse Gate Voltage	V_{GRM}				5	V

Thermal Characteristics

Maximum Thermal Resistance, Double Sided Cooling		Max.	Units
Junction-to-Case	$R_{\theta(J-C)}$	0.015	$^\circ\text{C}/\text{W}$
Case-to-Sink	$R_{\theta(C-S)}$	0.007	$^\circ\text{C}/\text{W}$

Powerex, Inc., 173 Pavilion Lane, Youngwood, Pennsylvania 15697 (724) 925-7272
www.pwr.com

Phase Control SCR
1200 Amperes Average
4400 Volts

Maximum On-State Forward Voltage Drop
($T_j = 125^\circ\text{C}$)

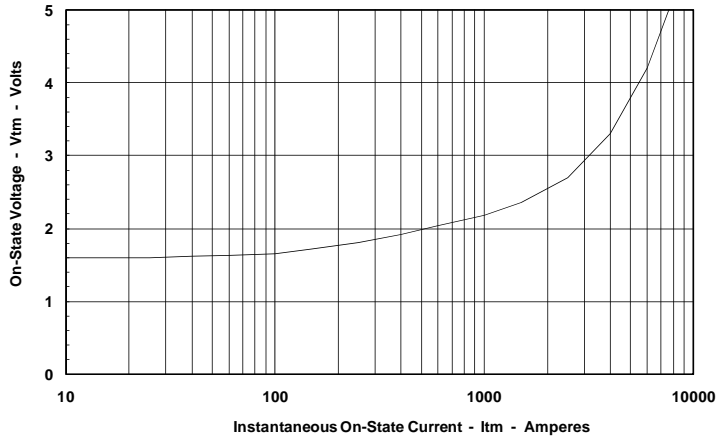

Maximum Transient Thermal Impedance
(Junction to Case)

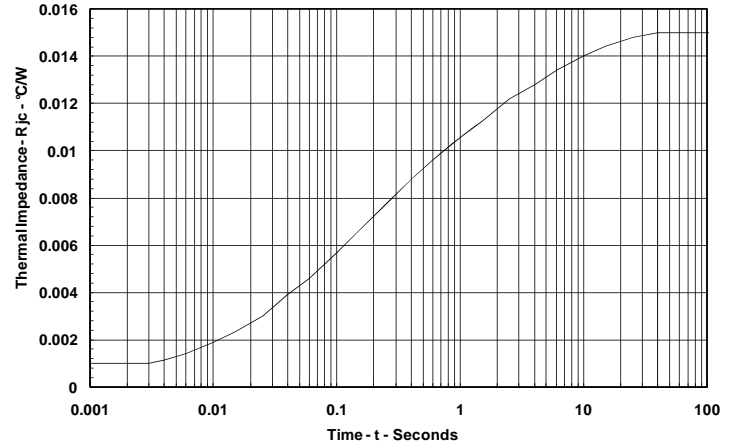

Maximum On-State Power Dissipation
(Sinusoidal Waveform)

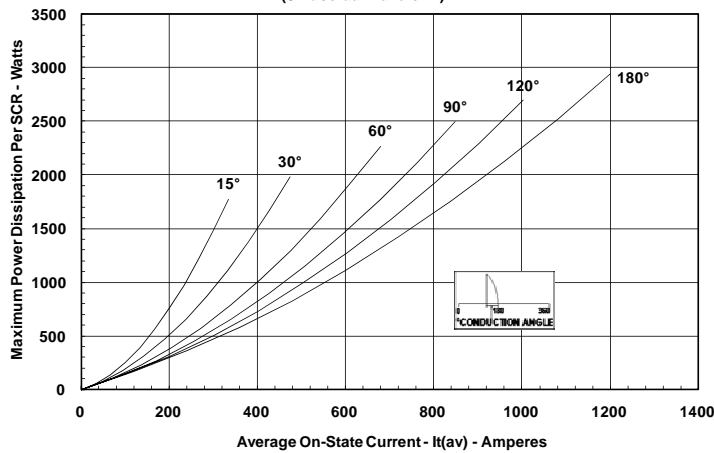

Maximum Allowable Case Temperature
(Sinusoidal Waveform)

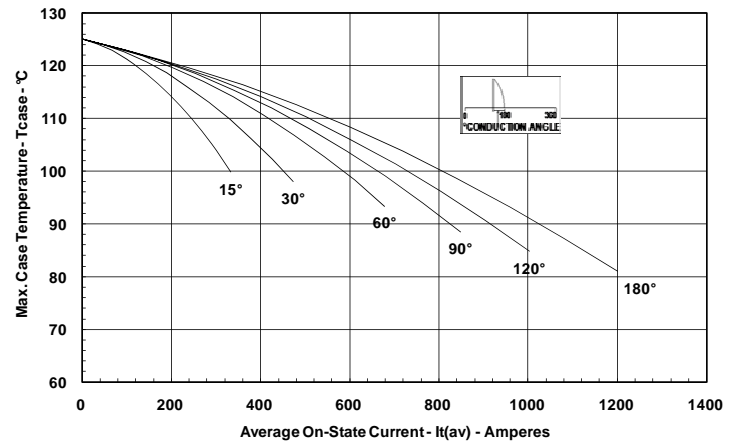

Maximum On-State Power Dissipation
(Rectangular Waveform)

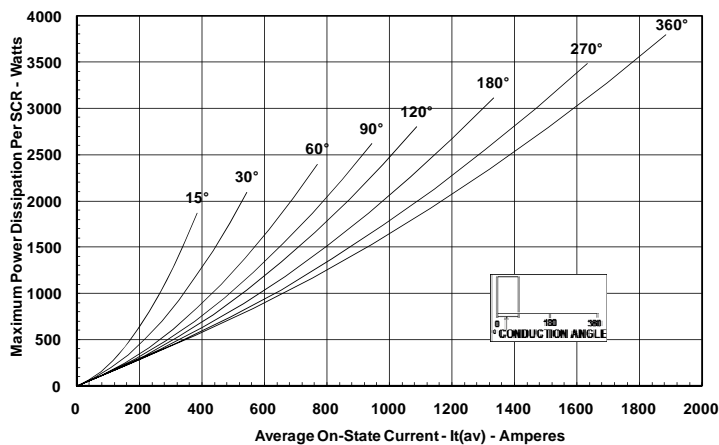

Maximum Allowable Case Temperature
(Rectangular Waveform)

