

Prepared by	S. Hirai	Revision: 1.0
Approved by	H. Yamaguchi	: Apr. 2009

MITSUBISHI HVDi MODULES
RM1500DC-66F

HIGH POWER SWITCHING USE
INSULATED TYPE

HVDi (High Voltage Diode) Modules

RM1500DC-66F

N/A

- I_F 2 x 1500 A
- V_{rm} 3300 V
- 2-element in a Pack
- Insulated Type
- Soft Recovery Diode
- AISiC Baseplate

APPLICATION

Traction drives, High Reliability Converters / Inverters, DC choppers

OUTLINE DRAWING & CIRCUIT DIAGRAM

Dimensions in mm

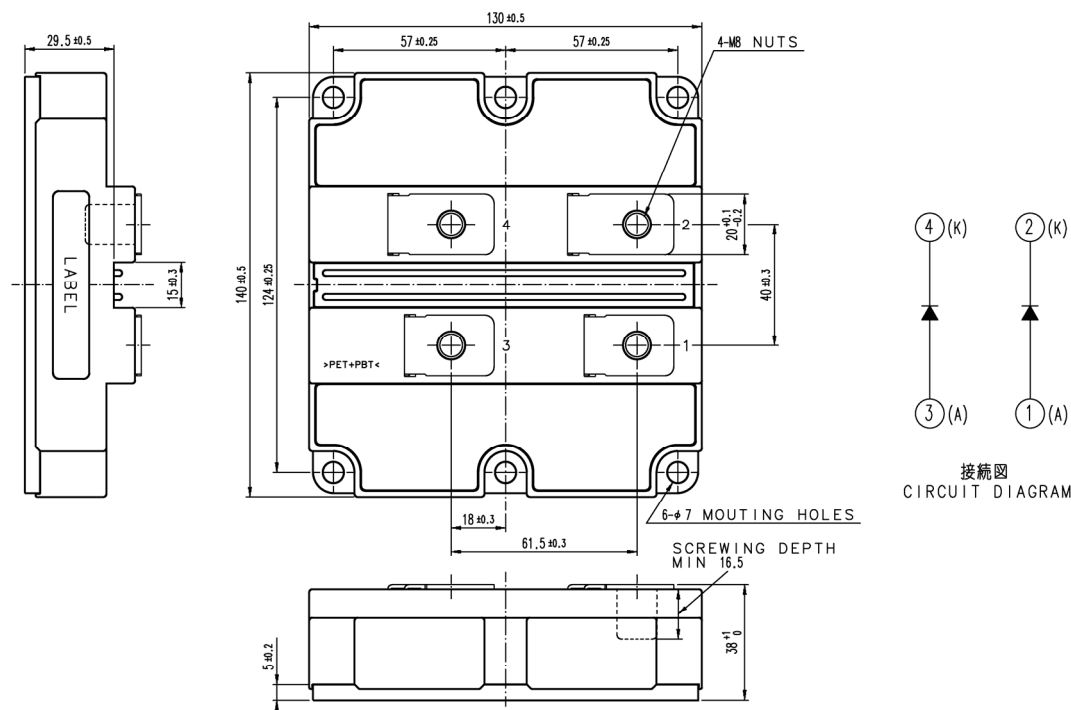

MITSUBISHI HVDi MODULES
RM1500DC-66F

HIGH POWER SWITCHING USE
 INSULATED TYPE

HVDi (High Voltage Diode) Modules

MAXIMUM RATINGS

Symbol	Item	Conditions	Ratings	Unit
V_{RRM}	Repetitive peak reverse voltage	$T_j = -40...+150^{\circ}\text{C}$	3300	V
		$T_j = -50^{\circ}\text{C}$	3200	
V_{RSM}	Non-repetitive peak reverse voltage	$T_j = -40...+150^{\circ}\text{C}$	3300	V
		$T_j = -50^{\circ}\text{C}$	3200	
I_F	Collector current	DC, $T_c = 25^{\circ}\text{C}$	1500	A
I_{FM}		Pulse ^(Note 1)	3000	A
I_{FSM}	Surge (non-repetitive) forward current	$T_j = 125^{\circ}\text{C}$, $V_R = 0\text{ V}$, $t = 10\text{ ms}$	14.0	kA
I^2t	Surge forward current integral	$T_j = 125^{\circ}\text{C}$, $V_R = 0\text{ V}$, $t = 10\text{ ms}$	980	kA^2s
V_{iso}	Isolation voltage	RMS, sinusoidal, $f = 60\text{Hz}$, $t = 1\text{ min.}$	6000	V
V_e	Partial discharge extinction voltage	RMS, sinusoidal, $f = 60\text{Hz}$, $Q_{PD} \leq 10\text{ pC}$	2600	V
T_j	Junction temperature		$-50 \sim +150$	$^{\circ}\text{C}$
T_{op}	Operating temperature		$-50 \sim +150$	$^{\circ}\text{C}$
T_{stg}	Storage temperature		$-55 \sim +150$	$^{\circ}\text{C}$

ELECTRICAL CHARACTERISTICS

Symbol	Item	Conditions	Limits			Unit	
			Min	Typ	Max		
I_{RRM}	Repetitive reverse current	$V_{RM} = V_{RRM}$	$T_j = 25^{\circ}\text{C}$	—	—	2.0	mA
			$T_j = 125^{\circ}\text{C}$	—	2.0	—	
			$T_j = 150^{\circ}\text{C}$	—	12.0	—	
V_{FM}	Forward voltage	$I_F = 1500\text{ A}$ ^(Note 2)	$T_j = 25^{\circ}\text{C}$	—	2.20	—	V
			$T_j = 125^{\circ}\text{C}$	—	2.40	2.90	
			$T_j = 150^{\circ}\text{C}$	—	2.35	—	
t_{rr}	Reverse recovery time		$T_j = 25^{\circ}\text{C}$	—	0.55	—	μs
			$T_j = 125^{\circ}\text{C}$	—	0.75	—	
			$T_j = 150^{\circ}\text{C}$	—	0.85	—	
I_{rr}	Reverse recovery current	$V_{CC} = 1800\text{ V}$ $I_C = 1500\text{ A}$ $V_{GE} = \pm 15\text{ V}$ $L_s = 100\text{ nH}$	$T_j = 25^{\circ}\text{C}$	—	1200	—	A
			$T_j = 125^{\circ}\text{C}$	—	1450	—	
			$T_j = 150^{\circ}\text{C}$	—	1500	—	
Q_{rr}	Reverse recovery charge	$-d_{IF}/d_t =$ 5500 A/ μs @ $T_j = 25^{\circ}\text{C}$ 5200 A/ μs @ $T_j = 125^{\circ}\text{C}$ 5100 A/ μs @ $T_j = 150^{\circ}\text{C}$	$T_j = 25^{\circ}\text{C}$	—	1050	—	μC
			$T_j = 125^{\circ}\text{C}$	—	1700	—	
			$T_j = 150^{\circ}\text{C}$	—	2000	—	
$E_{rec(10\%)}$	Reverse recovery energy ^(Note 3)	Inductive load	$T_j = 25^{\circ}\text{C}$	—	1.15	—	J/P
			$T_j = 125^{\circ}\text{C}$	—	1.85	—	
			$T_j = 150^{\circ}\text{C}$	—	2.10	—	
E_{rec}	Reverse recovery energy ^(Note 4)		$T_j = 25^{\circ}\text{C}$	—	1.30	—	J/P
			$T_j = 125^{\circ}\text{C}$	—	2.10	—	
			$T_j = 150^{\circ}\text{C}$	—	2.40	—	

HVDi (High Voltage Diode) MODULES

RM1500DC-66FHIGH POWER SWITCHING USE
INSULATED TYPE

HVDi (High Voltage Diode) Modules

THERMAL CHARACTERISTICS

Symbol	Item	Conditions	Limits			Unit
			Min	Typ	Max	
$R_{th(j-c)}$	Thermal resistance	Junction to Case, 1/2 module	—	—	16.0	K/kW
$R_{th(c-f)}$	Contact thermal resistance	Case to Fin, $\lambda_{grease} = 1W/m\cdot K$ $D_{(c-f)} = 100 \mu m$, 1/2 module	—	17.5	—	K/kW

MECHANICAL CHARACTERISTICS

Symbol	Item	Conditions	Limits			Unit
			Min	Typ	Max	
M_t	Mounting torque	M8: Main terminals screw	7.0	—	22.0	N·m
M_s		M6: Mounting screw	3.0	—	6.0	N·m
m	Mass		—	0.8	—	kg
CTI	Comparative tracking index		600	—	—	—
d_a	Clearance		19.5	—	—	mm
d_s	Creepage distance		32.0	—	—	mm
$L_{P AK}$	Parasitic stray inductance	1/2 module	—	33	—	nH
$R_{AA'+KK'}$	Internal lead resistance	$T_c = 25^\circ C$, 1/2 module	—	0.24	—	mΩ

Note 1. Pulse width and repetition rate should be such that junction temperature (T_j) does not exceed T_{opmax} rating (150°C).

Note 2. Pulse width and repetition rate should be such as to cause negligible temperature rise.

Note 3. $E_{rec(10\%)}$ is the integral of $0.1V_R \times 0.1I_F \times dt$.

Note 4. The integration range of E_{rec} according to IEC 60747.

RM1500DC-66F

HIGH POWER SWITCHING USE
INSULATED TYPE

HVDi (High Voltage Diode) Modules

PERFORMANCE CURVES

FORWARD CHARACTERISTICS (TYPICAL)

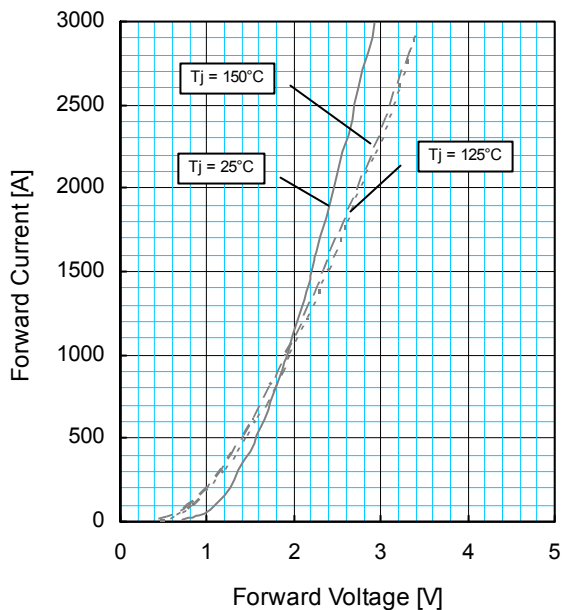

REVERSE RECOVERY CHARACTERISTICS (TYPICAL)

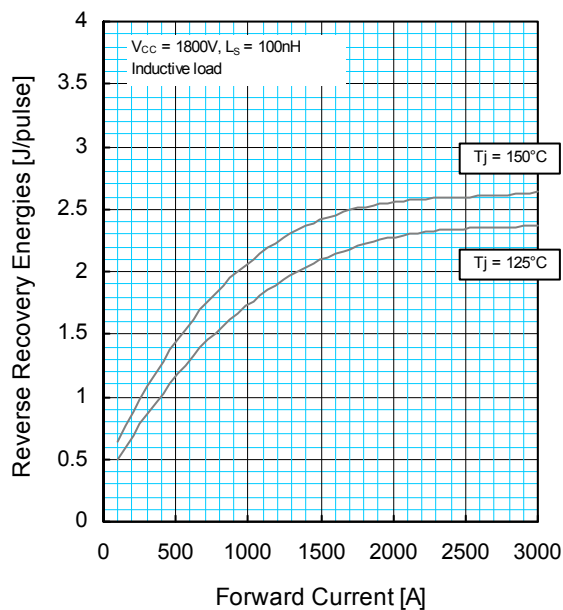

REVERSE RECOVERY CHARACTERISTICS (TYPICAL)

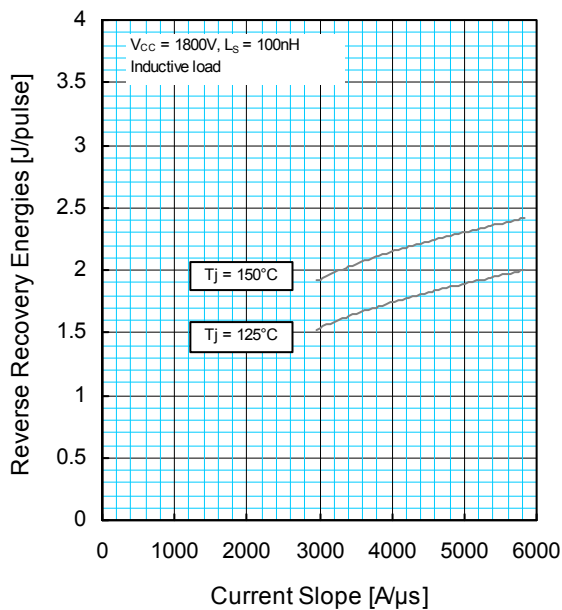

RM1500DC-66F

HIGH POWER SWITCHING USE
INSULATED TYPE

HVDi (High Voltage Diode) Modules

PERFORMANCE CURVES

REVERSE RECOVERY CHARACTERISTICS (TYPICAL)

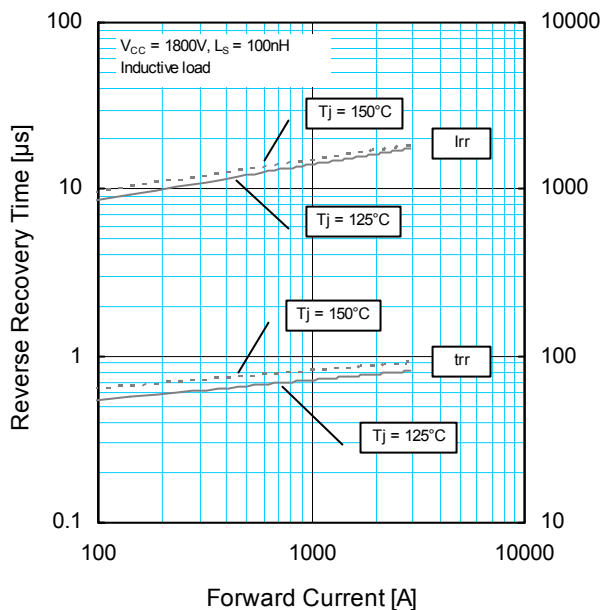

REVERSE RECOVERY SAFE OPERATING AREA (TYPICAL)

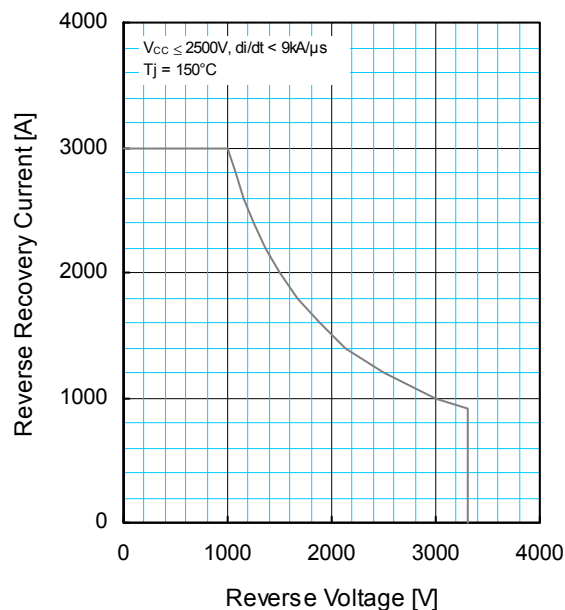

TRANSIENT THERMAL IMPEDANCE CHARACTERISTICS

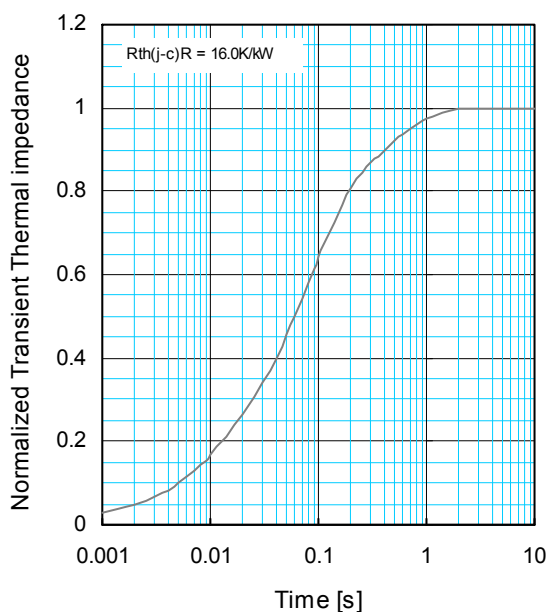

$$Z_{th(j-c)}(t) = \sum_{i=1}^n R_i \left\{ 1 - \exp\left(-\frac{t}{\tau_i}\right) \right\}$$

	1	2	3	4
R_i [K/kW] :	0.0059	0.0978	0.6571	0.2392
τ_i [sec] :	0.0002	0.0074	0.0732	0.4488

HVDi (High Voltage Diode) MODULES