

Fast Recovery Diode Module 100 Amperes/3300 Volts

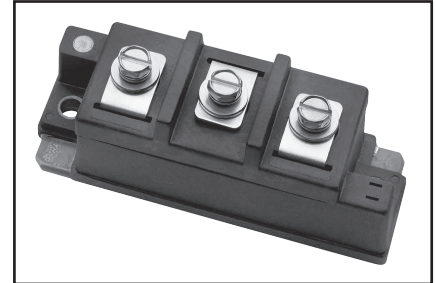
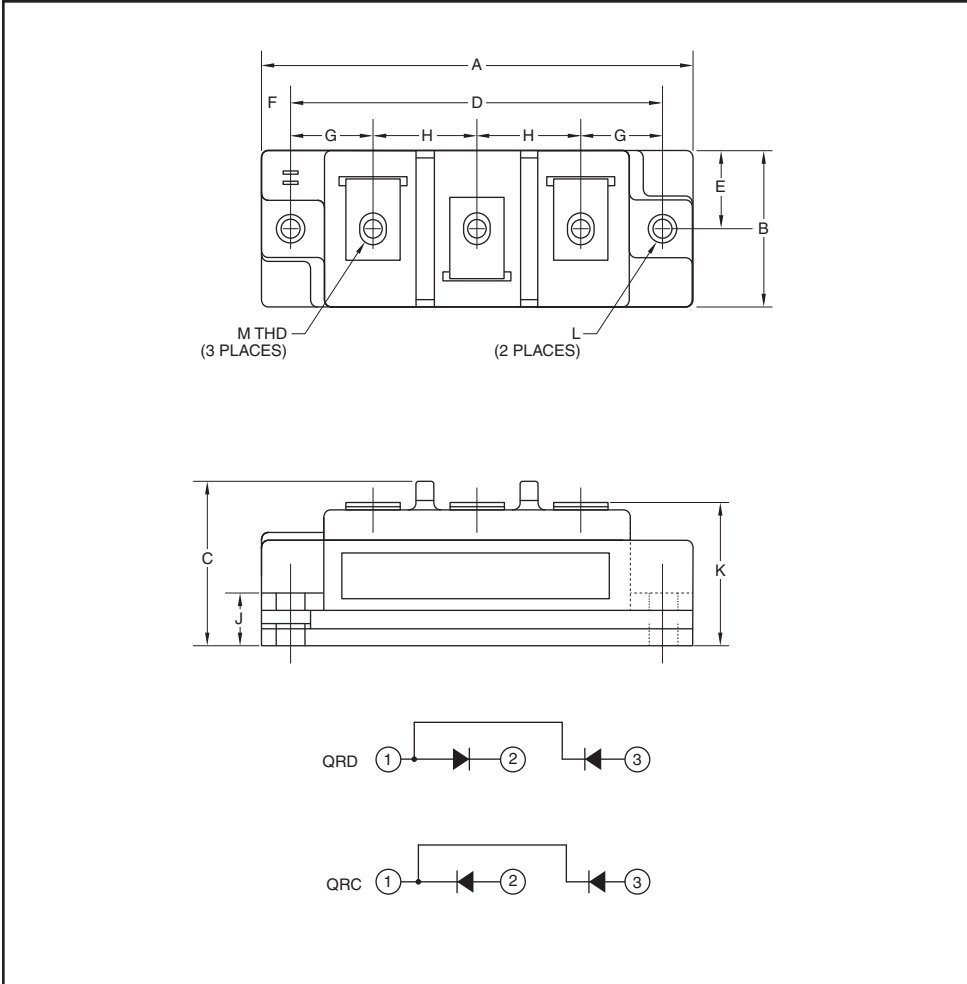

Description:

Powerex Fast Recovery Diode Modules are designed for use in applications requiring fast switching. The modules are isolated for easy mounting with other components on a common heatsink.

Features:

- Fast Recovery Time (1.2 μ s max.)
- Isolation Material - DBC Alumina
- Copper Baseplate
- Low Thermal Impedance
- 6000V Isolated Mounting

Applications:

- Switching Power Supplies
- Inverters
- Choppers
- Welding Power Supplies
- Free Wheeling Diode
- High Frequency Rectifiers

Outline Drawing and Circuit Diagram

Dimensions	Inches	Millimeters
A	3.70	94.0
B	1.34	34.0
C	1.40	35.6
D	3.15	80.0
E	0.67	17.0
F	0.28	6.99

Dimensions	Inches	Millimeters
G	0.67	17.1
H	0.91	23.0
J	0.36	9.0
K	1.18	30.0
L	0.216 Dia.	5.5 Dia.
M	#10-32	#10-32

QR_3310002
Fast Recovery Diode Module
 100 Amperes/3300 Volts

Absolute Maximum Ratings, $T_j = 25^\circ\text{C}$ unless otherwise specified

Ratings	Symbol	QRD3310002	Units
		QRC3310002	
Repetitive Peak Reverse Blocking Voltage	V_{RRM}	3300	Volts
Non-Repetitive Peak Reverse Blocking Voltage	V_{RSM}	$V_{RRM} + 100$	Volts
Average Forward Current	$I_{F(av)}$	$T_C = 80^\circ\text{C}$	60 Amperes
		$T_C = 25^\circ\text{C}$	90 Amperes
Forward Current (Pulse)	I_{FM}	200	Amperes
Operating Junction Temperature	T_j	-40 to 150	$^\circ\text{C}$
Storage Temperature	T_{stg}	-40 to 150	$^\circ\text{C}$
Maximum Mounting Torque, #10-32 Mounting Screw	—	26	in-lb
Maximum Terminal Torque, #10-32 Terminal Screw	—	26	in-lb
Module Weight (Typical)	—	250	Grams
V Isolation (60 Hz, Circuit to Base, All Terminals Shorted, $t = 1$ sec.)	V_{RMS}	6000	Volts

IGBT Electrical Characteristics, $T_j = 25^\circ\text{C}$ unless otherwise specified

Characteristics	Symbol	Test Conditions	Min.	Typ.	Max.	Units
Peak Reverse Leakage Current	I_{RRM}	Rated V_{RRM}	—	—	5	mA
Peak On-State Voltage	V_{FM}	$I_F = 100\text{A}$	—	3.3	4.3	Volts
Reverse Recovery Time	t_{rr}	$I_F = 100\text{A}$, $di/dt = -200\text{A}/\mu\text{s}$	—	—	1.2	μs
Reverse Recovery Charge	Q_{rr}	$I_F = 100\text{A}$, $di/dt = -200\text{A}/\mu\text{s}$	—	25	—	μC

Thermal and Mechanical Characteristics, $T_j = 25^\circ\text{C}$ unless otherwise specified

Characteristics	Symbol	Test Conditions	Min.	Typ.	Max.	Units
Thermal Resistance, Junction to Case	$R_{th(j-c)Q}$	Per Diode	—	—	0.20	$^\circ\text{C}/\text{W}$
Thermal Resistance, Case to Sink Lubricated	$R_{th(c-s)Q}$	Per Module	—	—	0.05	$^\circ\text{C}/\text{W}$

QR_3310002
Fast Recovery Diode Module
 100 Amperes/3300 Volts

MAXIMUM ON-STATE FORWARD VOLTAGE DROP CHARACTERISTICS
 ($T_j = 150^\circ\text{C}$)

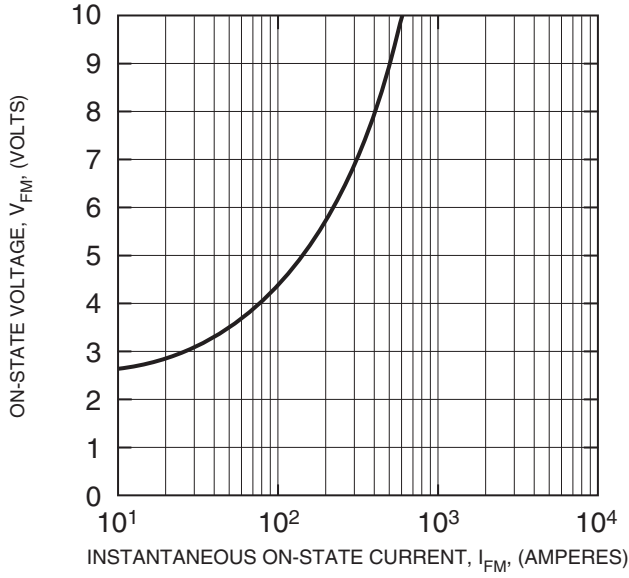

MAXIMUM TRANSIENT THERMAL IMPEDANCE CHARACTERISTICS
 (JUNCTION TO CASE)

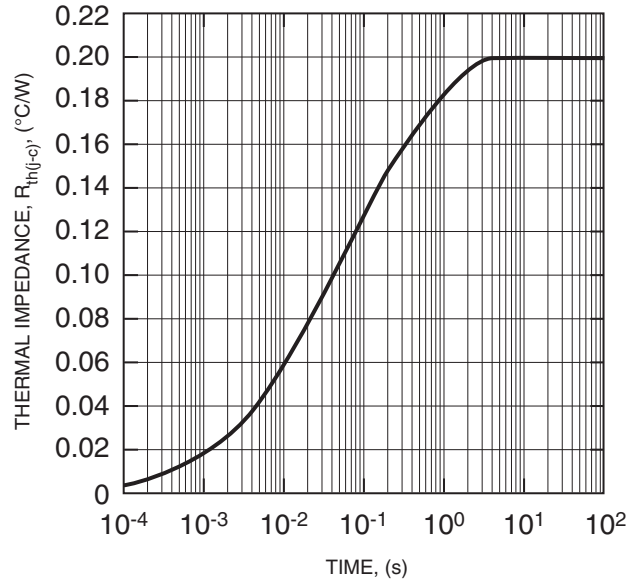

MAXIMUM ON-STATE POWER DISSIPATION
 (SINUSOIDAL WAVEFORM)

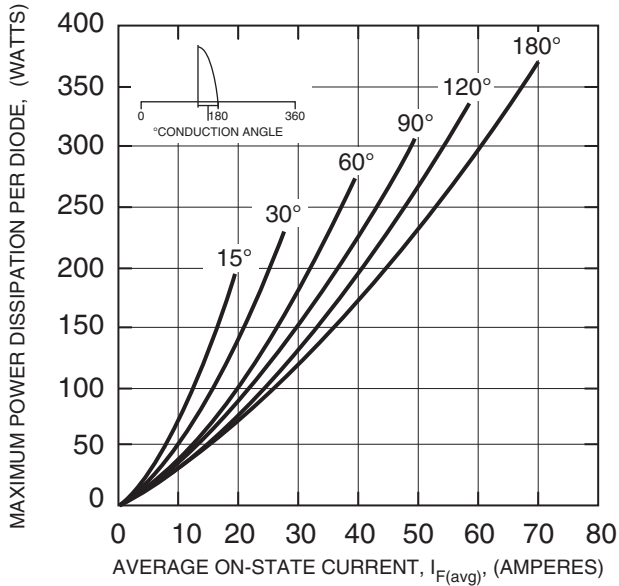

MAXIMUM ALLOWABLE CASE TEMPERATURE
 (SINUSOIDAL WAVEFORM)

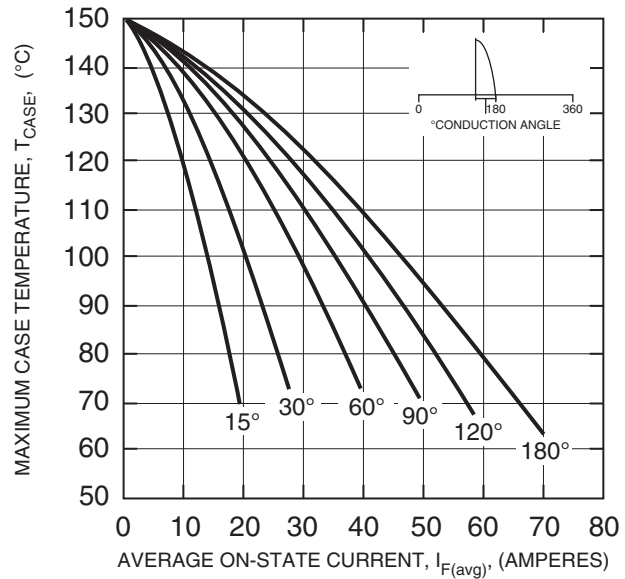

QR_3310002
Fast Recovery Diode Module
 100 Amperes/3300 Volts

**MAXIMUM ON-STATE
 POWER DISSIPATION
 (RECTANGULAR WAVEFORM)**

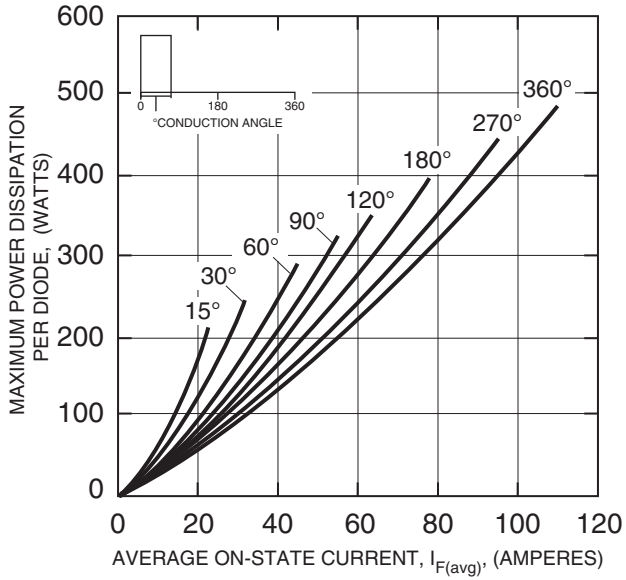

**MAXIMUM ALLOWABLE
 CASE TEMPERATURE
 (RECTANGULAR WAVEFORM)**

