

MICA CAPACITOR

Suntan® SM®

HIGH RELIABILITY AND STABILITY, COMPACT AND HIGH MOISTURE – RESISTANCE

TS23



S P E C I F I C A T I O N S

CAPACITANCE RANGE	1pF – 22,000pF
TOLERANCE	±0.5pF, ±1%, ±2%, ±5% ~ 20%
RATED VOLTAGE	DC 50V, 100V, 300V, 500V
OPERATING TEMPERATURE	-55°C ~ 125°C
INSULATION RESISTANCE	For C < 10,000pF more than 10M ⁵ after one Minute application of 100VDC at 25°C For C > 10,000pF more than 10M ⁴ after one Minute application of 100VDC at 25°C
Withstanding voltage	Rated voltage x 2 (VDC) within 1-5 seconds

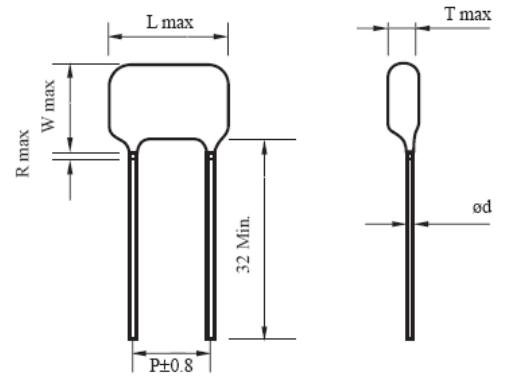

UNIT: mm

TYPE	RATED VDC	CAPACITANCE PF	L	W	T	R	P	D
DM5	100	1 ~ 270	7.5	7.5	5.0	3	3	0.4
	300	1 ~ 100						
DM10	100	1 ~ 390	10.0	9.5	5.5	3	4	
	300	1 ~ 300						
	500	1 ~ 240						
DM15	100	1 ~ 1,200	12.0	10.5	6.0	3	6	0.4
	300	1 ~ 820						
	500	1 ~ 510						
DM19	100	820 ~ 8,200	18.0	15.5	9.0	3.5	9	0.8
	300	620 ~ 6,200						
	500	510 ~ 5,100						
DM20	100	820 ~ 18,000	21.0	16.5	11.0	3.5	11	
	300	620 ~ 12,000						
	500	510 ~ 10,000						
DM30	100	6,200 ~ 39,000	21.0	23.5	12.0	4	11	1.0
	300	6,200 ~ 30,000						
	500	6,200 ~ 22,000						
DM42	100	22,000 ~ 100,000	38.0	25.5	13.0	4	25	
	300	22,000 ~ 68,000						
	500	22,000 ~ 51,000						

Note: Specification are subject to change without notice. For more detail and update, please visit our website.