

SRS05A-XX Series

Miniature, Non-isolated 5A Output, Switching POL Regulators

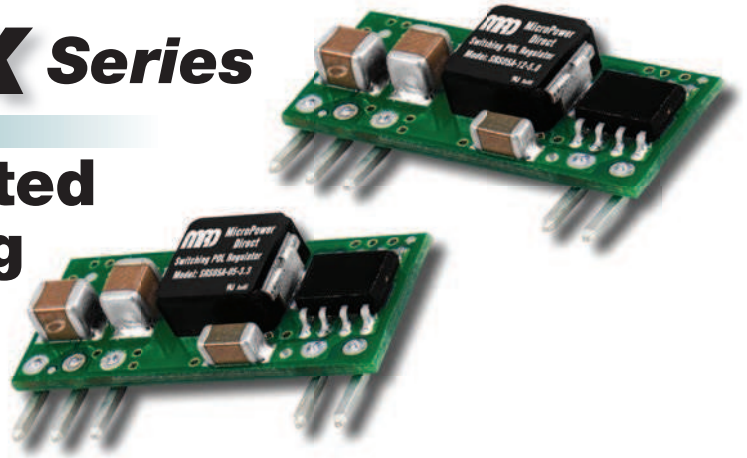

Key Features:

- 5A Output Current
- Efficiency to 94%
- EN 60950 Approved (UL)
- Compact SIP Case
- Wide Input Range
- Short Circuit Protected
- Thermal Shutdown
- Remote On/Off Control
- Industry Standard Footprint



MicroPower Direct

292 Page Street
Suite D
Stoughton, MA 02072
USA

T: (781) 344-8226

F: (781) 344-8481

E: sales@micropowerdirect.com

W: www.micropowerdirect.com



Electrical Specifications

Specifications typical @ +25°C, nominal input voltage & rated output current, unless otherwise noted. Specifications subject to change without notice.

Input

Parameter	Conditions	Min.	Typ.	Max.	Units
Input Voltage Range	5V Input	3.0	5.0	5.5	VDC
	12V Input	8.3	12.0	14.0	
Under Voltage Lockout, Power Up	5V Input		2.0		VDC
	12V Input		8.0		
Under Voltage Lockout, Power Down	5V Input		1.9		VDC
	12V Input		7.9		
Input Filter	Capacitive				
Input Reflected Ripple Current	See Note 1		150		mA P-P

Output

Parameter	Conditions	Min.	Typ.	Max.	Units
Output Voltage/Current	See Model Selection Guide				
Output Voltage Tolerance				±1.5	%
Line Regulation, See Note 2	5V Input			±0.4	%
	12V Input			±0.2	
Load Regulation	I _{OUT} = 0% to 100%, V _{OUT} = 3.3 VDC			±0.5	%
Ripple & Noise (20 MHz)	See Note 3			50	mV P-P
				20	mV RMS
Transient Recovery Time, See Note 4	50% Load Change			200	µSec
Transient Response Deviation			±1.0		%
Temperature Coefficient				±0.03	%/°C
Short Circuit Protection	Continuous (Hiccup Mode)				
Over Temperature Protection	See Note 5		120		°C
Overload Protection	See Note 6		150		%

General

Parameter	Conditions	Min.	Typ.	Max.	Units
Isolation Voltage	Not Isolated				
Switching Frequency	Fixed		300		kHz

Remote On/Off, See Note 7

Parameter	Conditions	Min.	Typ.	Max.	Units
Unit On	Logic High			Open or V _{IN}	
Unit Off	Logic Low	0.0		0.4	VDC
On/Off Current	V _{ON} /V _{OFF} = 0.0V			1	mA

Environmental

Parameter	Conditions	Min.	Typ.	Max.	Units
Operating Temperature Range	Ambient	-40	+25	+85	°C
Storage Temperature Range		-55		+125	°C
Cooling	Free Air Convection (See Derating Curves)				
Humidity	RH, Non-condensing			93	%

Physical

Size	0.90 x 0.40 x 0.22 Inches (22.9 x 10.16 x 5.6 mm)				
Weight	0.081 Oz (2.3g)				

Reliability Specifications

Parameter	Conditions	Min.	Typ.	Max.	Units
MTBF	MIL HDBK 217F, 25°C, Gnd Benign		1.5		MHours
Safety Standards	UL 60950, EN 60950				

www.micropowerdirect.com

Model Number	Input			Output			Efficiency (% Typ)	Capacitive Load (µF Max)	Fuse Rating Slow-Blow (A)
	Voltage (VDC) Range	Current (mA) Full-Load	Current (mA) No-Load	Voltage (VDC)	Current (A, Max)	Current (A, Min)			
SRS05A-05-3.3	3.0 - 5.5	949	25	0.75	5.0	0.0	79	3,000	10
		1,412	30	1.20			85		
		1,724	30	1.50			87		
		2,022	35	1.80			89		
		2,222	35	2.00			90		
		2,217	35	2.50			92		
SRS05A-12-5.0	8.3 - 14.0	3,511	35	3.30	5.0	0.0	94	3,000	7
		428	20	0.75			73		
		625	25	1.20			80		
		762	25	1.50			82		
		893	30	1.80			84		
		980	30	2.00			85		
		1,197	35	2.50			87		
		1,545	45	3.30			89		
2,264	50	5.00	92						

Notes:

1. Measured over a bandwidth of 5 Hz to 20 MHz using a 1 µH inductor.
2. Line regulation is measured for a VIN change from low line to high line, with VOUT set to 1.8 VDC.
3. Output ripple is measured at 20 MHz bandwidth using a 1.0 µF ceramic capacitor and a 10 µF tantalum capacitor connected in parallel as close to the output terminals as possible. For the SRS05A-12-5.0, when set for a 5 VDC output, the output ripple and noise is:

Peak to Peak	75 mV P - P
RMS	45 mV RMS

4. Transient recovery is measured to within a 1% error band for a 50% load change.
5. These units include a non-latching over temperature protection circuit. If the temperature exceeds approximately 120°C at the monitored "hot spot", the unit will be shut down. When the temperature decreases, the unit will automatically restart.
6. These units will provide up to 150% of rated current. In the event of an over current fault, the unit will go into hiccup mode until the fault is removed.
7. Standard units feature an active high remote control input. See the note and diagram at right.
8. These units do not include an internal fuse. It is recommended that an external slow-blow fuse be used with a rating as shown in the table above.

Remote On/Off

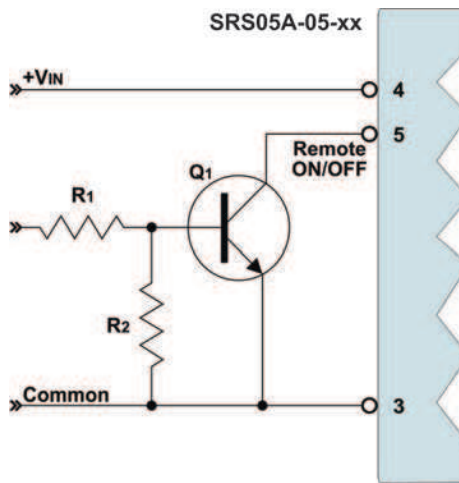

These units include an active high On/OFF control input. The unit is "ON" if the input to the control pin (pin 5) is high; or if the pin is left open (or floating). The signal level of the control input is referenced to ground. A recommended drive circuit for the control pin is shown at left. The resistors R1 & R2 have been added to help reduce possible false triggering of the control input due to leakage currents.

Units are available with an active low control input. With this input, the unit will remain off if the control input remains above 2.8 VDC. For more information on the active low option, contact the factory.

Output Voltage Trim

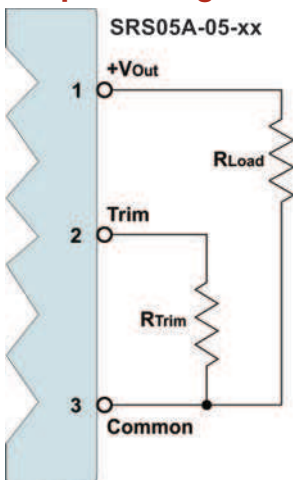

The output voltage level of the SRS05A series is adjustable over a wide range by the simple addition of an external resistor. This trim resistor is connected between the circuit common and the trim input (pin 2), as shown in the diagram above.

SRS05A-05-3.3	
VOUT (VDC)	RTRIM (kΩ)
0.75	Open
1.20	41.71
1.50	22.98
1.80	14.96
2.00	11.75
2.50	6.93
3.30	3.15
3.63	2.20

The output voltage of the SRS05A-05-3.3 models is adjustable over the range of 0.75 VDC to 3.63 VDC. The required resistor value for various output levels is given in the table above. To calculate the correct value for a different output level, the formula is:

$$R_{TRIM} = \left(\frac{21,070}{V_{OUT} - 0.75} - 5,110 \right)$$

Where: RTRIM = The external trim resistor
 VOUT = The desired output voltage
 If a trim resistor is not connected, the output goes to 0.75 VDC.

SRS05A-12-5.0	
VOUT (VDC)	RTRIM (kΩ)
0.75	Open
1.20	22.33
1.50	13.00
1.80	9.00
2.00	7.40
2.50	5.00
3.30	3.12
5.00	1.47

The output voltage of the SRS05A-12-5.0 models is adjustable over the range of 0.75 VDC to 5.00 VDC. The required resistor value for various output levels is given in the table above. To calculate the correct value for a different output level, the formula is:

$$R_{TRIM} = \left(\frac{10,500}{V_{OUT} - 0.75} - 1,000 \right)$$

Where: RTRIM = The external trim resistor
 VOUT = The desired output voltage
 If a trim resistor is not connected, the output goes to 0.75 VDC.



Derating Curves

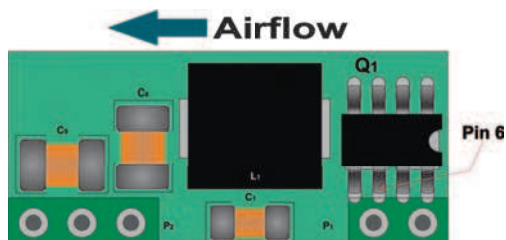
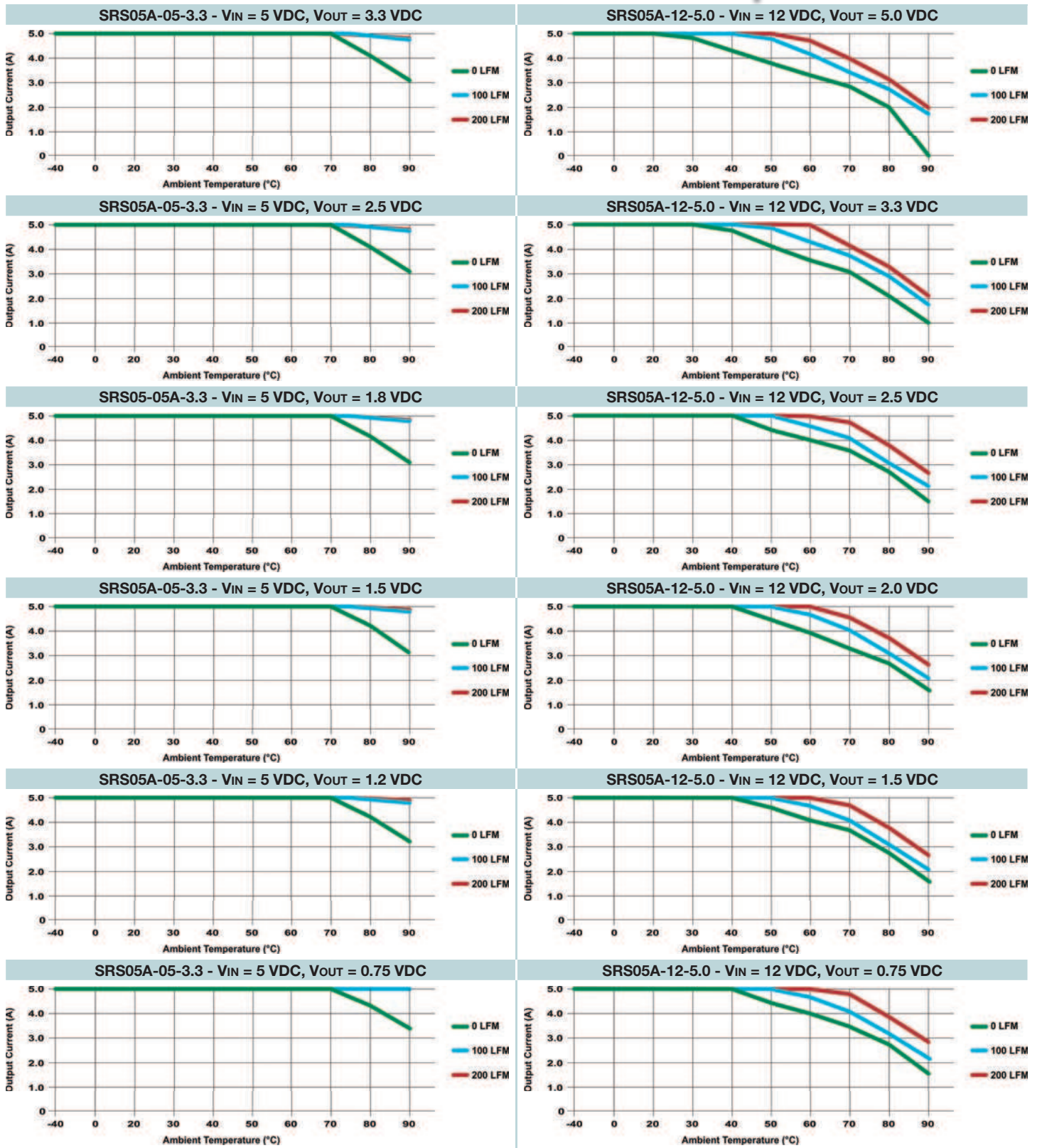

Temperature Measurement

These switching regulators may be used in a wide variety of thermal environments, but must be properly cooled to ensure long reliable operation. The derating curves shown above are approximations of the ambient temperature and airflow required to maintain the switching regulator temperature below its maximum rating. Airflow should move parallel to the long axis of the unit, as shown at left. Proper cooling can be verified by measuring the temperature at pin six of Q1 (as shown at left). The thermocouple should be mounted approximately 0.5 in. off the unit board. The temperature at this location should not exceed 110°C.

Typical Connection

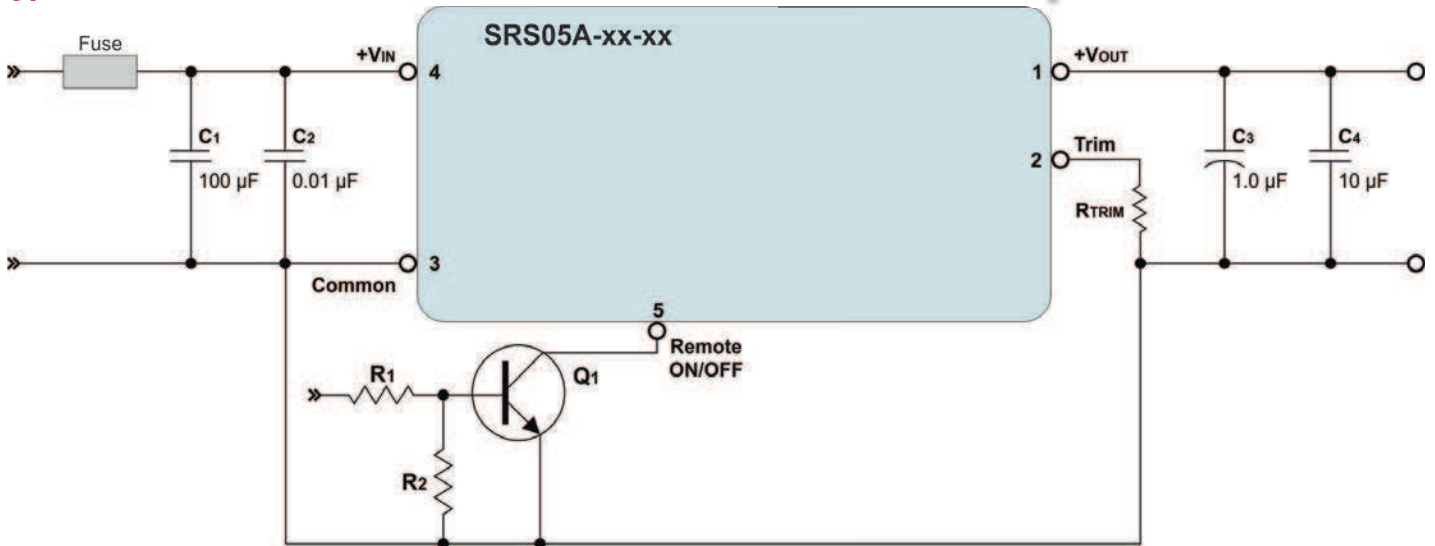

Notes:

Fuse: SRS05 regulators do not include an internal fuse. For safety and protection, an external slow-blow fuse should be placed in the input (+VIN) line. A 10A fuse is recommended for the SRS05A-05 and a 7A fuse for the SRS05A-12.

Input Filter: The unit must be connected to a low AC impedance source, and to avoid loop stability issues, the source inductance should also be low. To significantly reduce ripple caused by the switching action of the POL, the SRS05A includes onboard filtering. However, adding input capacitors C1 and C2 will further reduce ripple currents (C1) and high frequency noise spikes (C2). These capacitors should be placed as close to the input pins as possible (see board layout at right). It is recommended that low ESR (<100 mΩ) and low ESL ceramic capacitors be used. Recommended values are:

C1	C2
33 µF to 250 µF	0.01 µF

Remote ON/OFF: See note on page 2

Output Trim: See note on page 2

Output Filter: Output filtering is not required, but may be used to further reduce output ripple & noise; or to adjust the transient response time of the unit. Care must be taken not to exceed 3,000 µF, the maximum value of output capacitance the unit is rated for. The values given in the connection diagram are typical for light filtering.

Suggested Board Layout

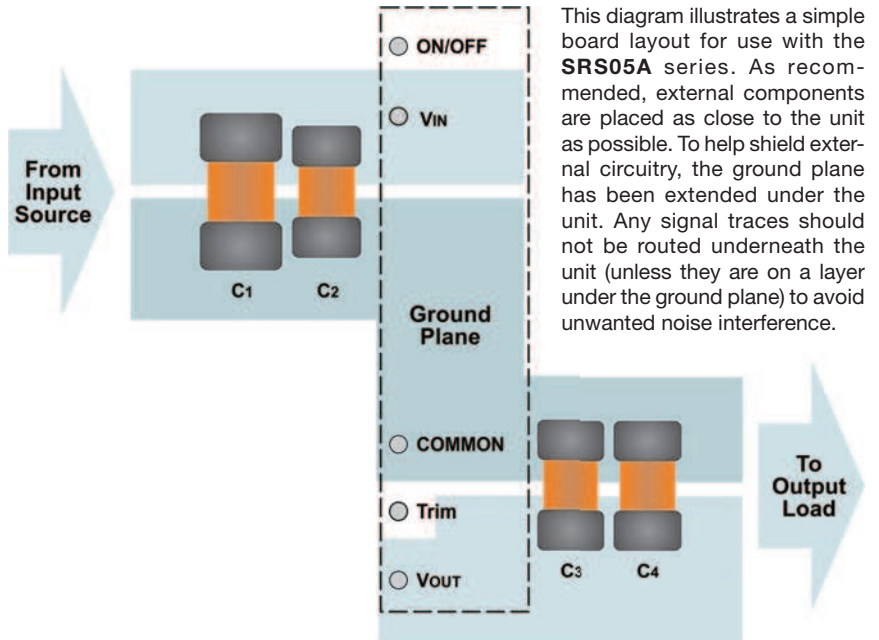

This diagram illustrates a simple board layout for use with the SRS05A series. As recommended, external components are placed as close to the unit as possible. To help shield external circuitry, the ground plane has been extended under the unit. Any signal traces should not be routed underneath the unit (unless they are on a layer under the ground plane) to avoid unwanted noise interference.

Mechanical Dimensions

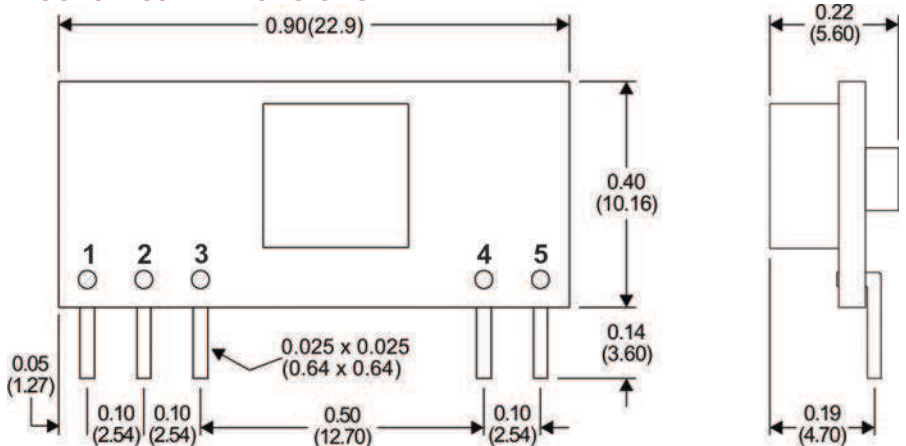

Pin Connections

Pin	Description
1	+V Output
2	Trim
3	Common
4	+V Input
5	Remote On/Off

Notes:

- All dimensions are typical in inches (mm)
- Tolerance x.xx = ±0.02 (±0.50)



MicroPower Direct

We Power Your Success - For Less!