

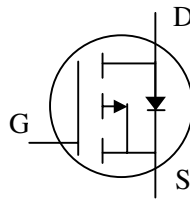

P-channel Enhancement-mode Power MOSFET

- Simple Drive Requirement
- Fast Switching Characteristics
- Low Gate Charge
- RoHS-compliant, halogen-free



| | |
|--------------|-------|
| BV_{DSS} | -200V |
| $R_{DS(ON)}$ | 680mΩ |
| I_D | -8A |

Description

Advanced Power MOSFETs from APEC provide the designer with the best combination of fast switching, low on-resistance and cost-effectiveness.

The AP9120GH-HF-3 is in the TO-252 package which is widely preferred for commercial and industrial surface mount applications such as medium-power DC/DC converters. The through-hole TO-251 version (AP9120GJ-HF-3) is available where a small PCB footprint is required.

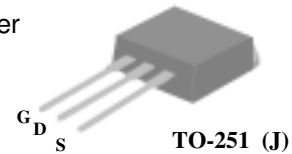

Absolute Maximum Ratings

| Symbol | Parameter | Rating | Units |
|--|---------------------------------------|------------|-------|
| V_{DS} | Drain-Source Voltage | -200 | V |
| V_{GS} | Gate-Source Voltage | ±20 | V |
| I_D at $T_C=25\text{ }^\circ\text{C}$ | Continuous Drain Current ³ | -8 | A |
| I_D at $T_C=100\text{ }^\circ\text{C}$ | Continuous Drain Current ³ | -5 | A |
| I_{DM} | Pulsed Drain Current ¹ | -30 | A |
| P_D at $T_C=25\text{ }^\circ\text{C}$ | Total Power Dissipation | 96 | W |
| | Linear Derating Factor | 0.77 | W/°C |
| T_{STG} | Storage Temperature Range | -55 to 150 | °C |
| T_J | Operating Junction Temperature Range | -55 to 150 | °C |

Thermal Data

| Symbol | Parameter | Value | Unit |
|--------|--|-------|------|
| Rthj-c | Maximum Thermal Resistance, Junction-case | 1.3 | °C/W |
| Rthj-a | Maximum Thermal Resistance, Junction-ambient(PCB mount) ³ | 62.5 | °C/W |
| Rthj-a | Maximum Thermal Resistance, Junction-ambient | 110 | °C/W |

Ordering Information

- AP9120GH-HF-3TR** **RoHS-compliant halogen-free TO-252 shipped on tape and reel (3000 pcs/reel)**
- AP9120GJ-HF-3TB** **RoHS-compliant halogen-free TO-251 shipped in tubes (80pcs/tube)**



Electrical Specifications at $T_j=25^\circ\text{C}$ (unless otherwise specified)

| Symbol | Parameter | Test Conditions | Min. | Typ. | Max. | Units |
|--------------|--|--------------------------------|------|------|-----------|------------|
| BV_{DSS} | Drain-Source Breakdown Voltage | $V_{GS}=0V, I_D=-250\mu A$ | -200 | - | - | V |
| $R_{DS(ON)}$ | Static Drain-Source On-Resistance ² | $V_{GS}=-10V, I_D=-4A$ | - | - | 680 | m Ω |
| $V_{GS(th)}$ | Gate Threshold Voltage | $V_{DS}=V_{GS}, I_D=-250\mu A$ | -2 | - | -4 | V |
| g_{fs} | Forward Transconductance | $V_{DS}=-10V, I_D=-5A$ | - | 7 | - | S |
| I_{DSS} | Drain-Source Leakage Current | $V_{DS}=-200V, V_{GS}=0V$ | - | - | -25 | μA |
| | Drain-Source Leakage Current ($T_j=125^\circ\text{C}$) | $V_{DS}=-160V, V_{GS}=0V$ | - | - | -250 | μA |
| I_{GSS} | Gate-Source Leakage | $V_{GS}=\pm 20V, V_{DS}=0V$ | - | - | ± 100 | nA |
| Q_g | Total Gate Charge ² | $I_D=-5A$ | - | 35 | 56 | nC |
| Q_{gs} | Gate-Source Charge | $V_{DS}=-160V$ | - | 6 | - | nC |
| Q_{gd} | Gate-Drain ("Miller") Charge | $V_{GS}=-10V$ | - | 15 | - | nC |
| $t_{d(on)}$ | Turn-on Delay Time ² | $V_{DS}=-100V$ | - | 13.5 | - | ns |
| t_r | Rise Time | $I_D=-5A$ | - | 16 | - | ns |
| $t_{d(off)}$ | Turn-off Delay Time | $R_G=10\Omega$ | - | 52 | - | ns |
| t_f | Fall Time | $V_{GS}=-10V$ | - | 25 | - | ns |
| C_{iss} | Input Capacitance | $V_{GS}=0V$ | - | 1210 | - | pF |
| C_{oss} | Output Capacitance | $V_{DS}=-25V$ | - | 170 | - | pF |
| C_{rss} | Reverse Transfer Capacitance | $f=1.0\text{MHz}$ | - | 45 | - | pF |
| R_g | Gate Resistance | $f=1.0\text{MHz}$ | - | 3.6 | 5.4 | Ω |

Source-Drain Diode

| Symbol | Parameter | Test Conditions | Min. | Typ. | Max. | Units |
|----------|------------------------------------|-----------------------|------|------|------|---------|
| V_{SD} | Forward On Voltage ² | $I_S=-5A, V_{GS}=0V$ | - | - | -1.3 | V |
| t_{rr} | Reverse Recovery Time ² | $I_S=-5A, V_{GS}=0V,$ | - | 200 | - | ns |
| Q_{rr} | Reverse Recovery Charge | $dI/dt=-100A/\mu s$ | - | 2 | - | μC |

Notes:

1. Pulse width limited by maximum junction temperature.
2. Pulse test - pulse width $\leq 300\mu s$, duty cycle $\leq 2\%$
3. Surface mounted on 1 in² copper pad of FR4 board,

THIS PRODUCT IS SENSITIVE TO ELECTROSTATIC DISCHARGE, PLEASE HANDLE WITH CAUTION.

USE OF THIS PRODUCT AS A CRITICAL COMPONENT IN LIFE SUPPORT OR OTHER SIMILAR SYSTEMS IS NOT AUTHORIZED.

APEC DOES NOT ASSUME ANY LIABILITY ARISING OUT OF THE APPLICATION OR USE OF ANY PRODUCT OR CIRCUIT DESCRIBED HEREIN; NEITHER DOES IT CONVEY ANY LICENSE UNDER ITS PATENT RIGHTS, NOR THE RIGHTS OF OTHERS.

APEC RESERVES THE RIGHT TO MAKE CHANGES WITHOUT FURTHER NOTICE TO ANY PRODUCTS HEREIN TO IMPROVE RELIABILITY, FUNCTION OR DESIGN.



Typical Electrical Characteristics

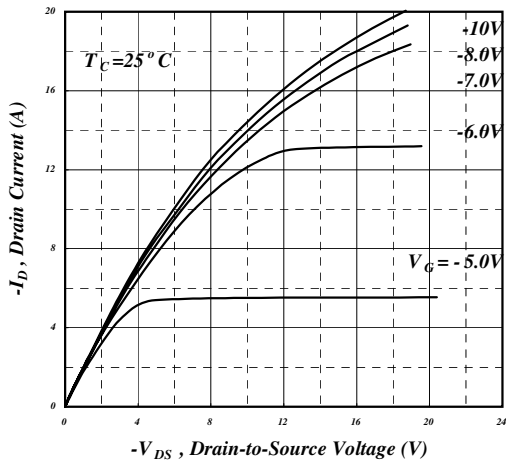

Fig 1. Typical Output Characteristics

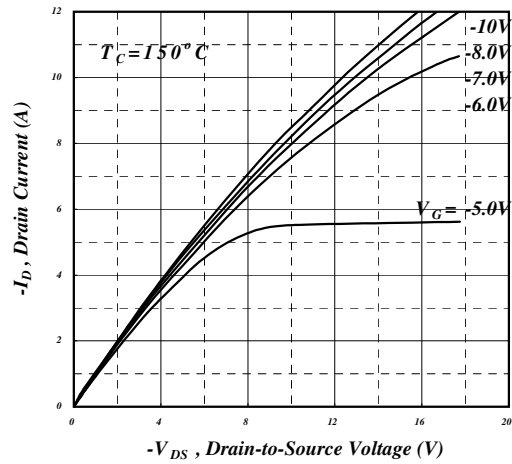

Fig 2. Typical Output Characteristics

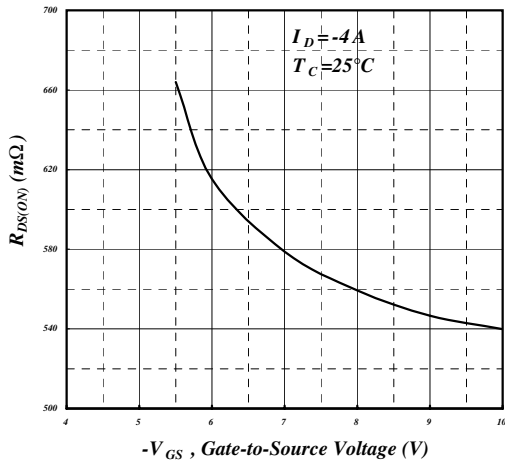

Fig 3. On-Resistance vs. Gate Voltage

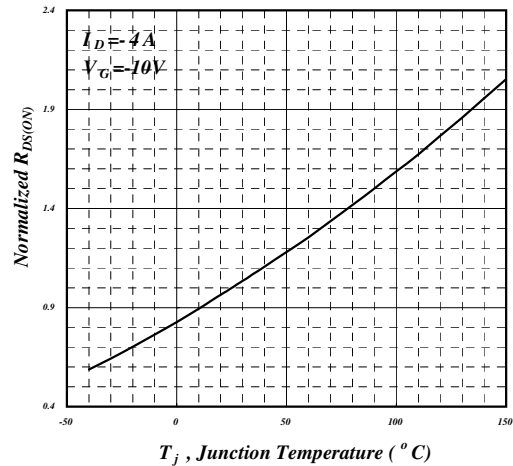

Fig 4. Normalized On-Resistance vs. Junction Temperature

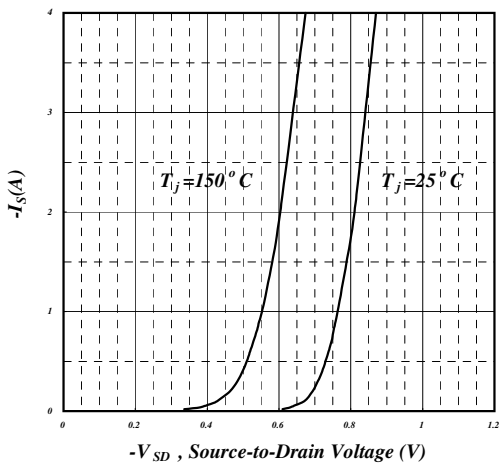

Fig 5. Forward Characteristic of Reverse Diode

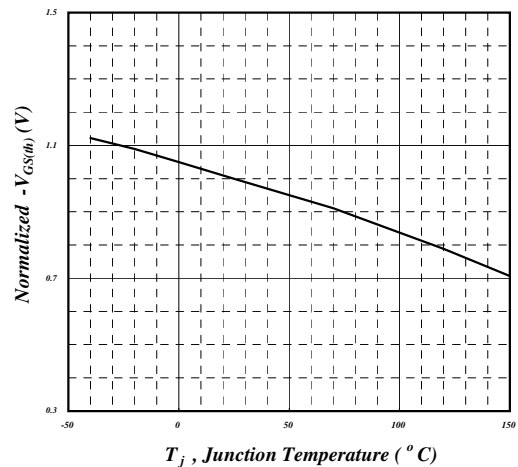

Fig 6. Gate Threshold Voltage vs. Junction Temperature



Typical Electrical Characteristics (cont.)

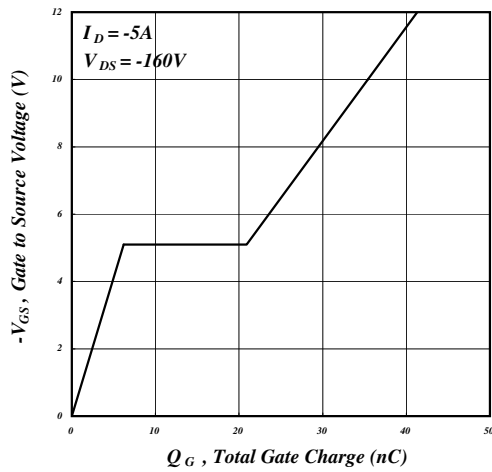

Fig 7. Gate Charge Characteristics

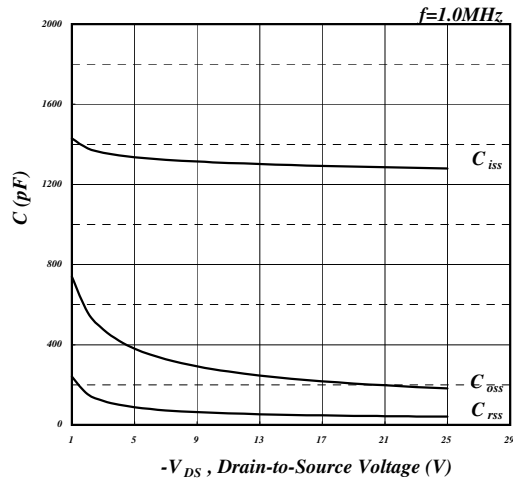

Fig 8. Typical Capacitance Characteristics

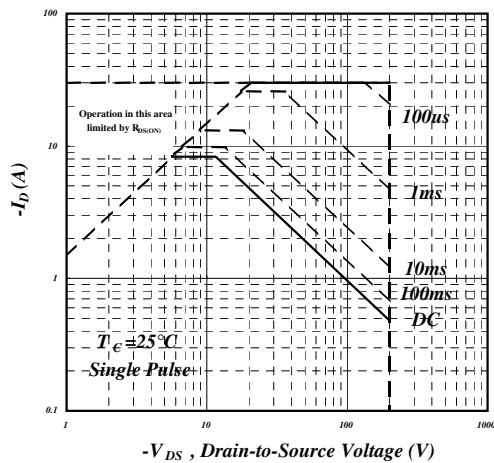

Fig 9. Maximum Safe Operating Area

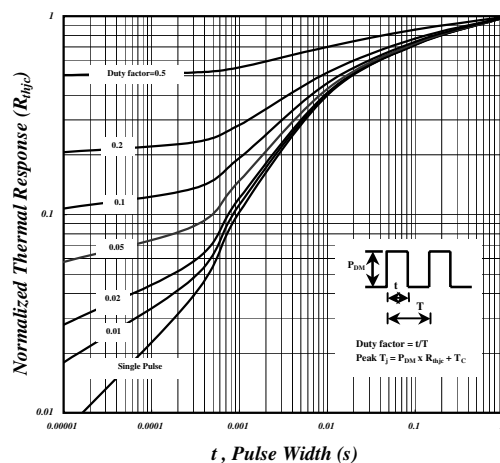

Fig 10. Effective Transient Thermal Impedance

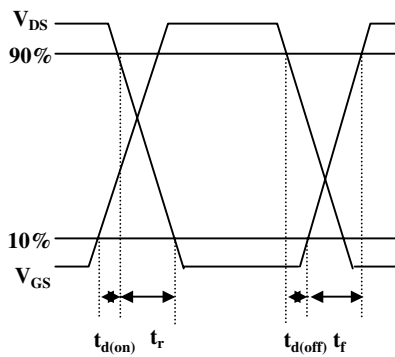

Fig 11. Switching Time Waveforms

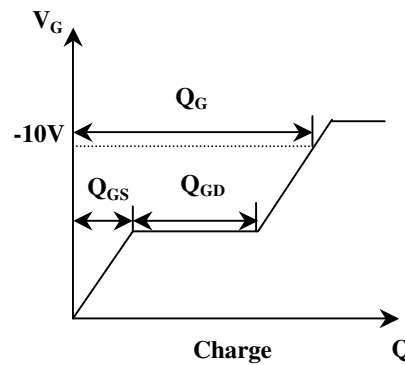
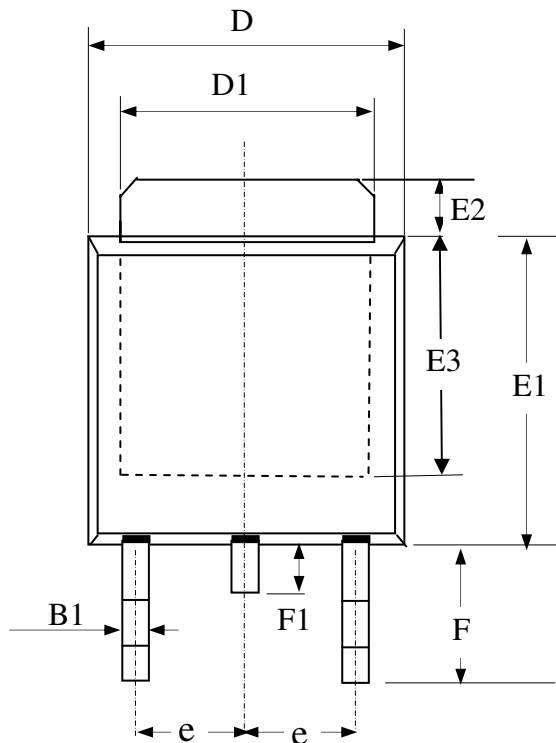

Fig 12. Gate Charge Waveform



Package Dimensions: TO-252



| SYMBOLS | Millimeters | | |
|---------|-------------|------|------|
| | MIN | NOM | MAX |
| A2 | 1.80 | 2.30 | 2.80 |
| A3 | 0.40 | 0.50 | 0.60 |
| B1 | 0.40 | 0.70 | 1.00 |
| D | 6.00 | 6.50 | 7.00 |
| D1 | 4.80 | 5.35 | 5.90 |
| E3 | 3.50 | 4.00 | 4.50 |
| F | 2.20 | 2.63 | 3.05 |
| F1 | 0.50 | 0.85 | 1.20 |
| E1 | 5.10 | 5.70 | 6.30 |
| E2 | 0.50 | 1.10 | 1.80 |
| e | -- | 2.30 | -- |
| C | 0.35 | 0.50 | 0.65 |

1. All dimensions are in millimeters.
2. Dimensions do not include mold protrusions.

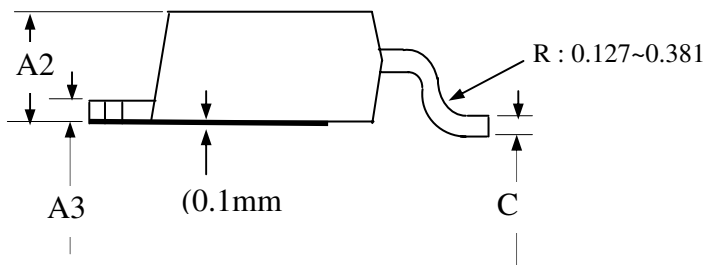

Marking Information: TO-252

Laser Marking

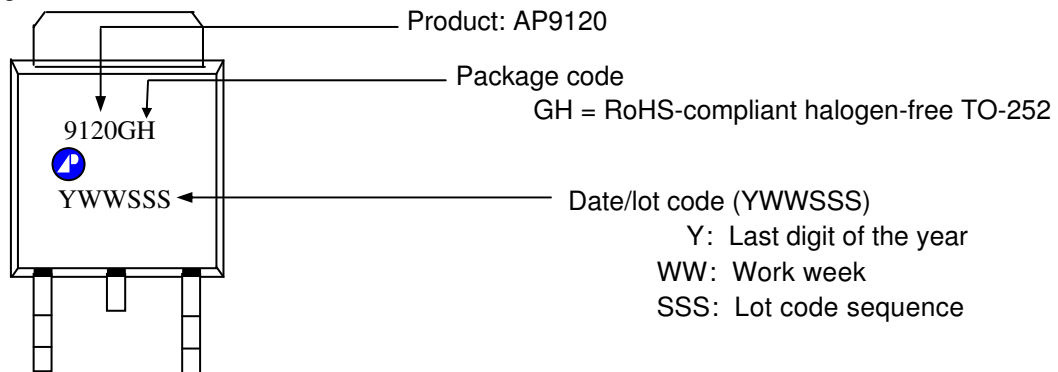



Package Dimensions: TO-251

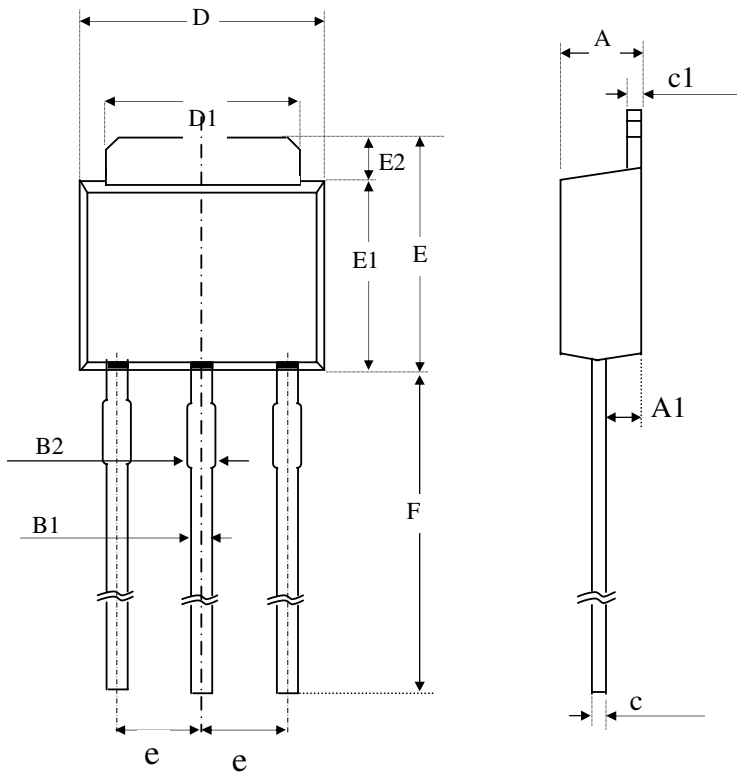

| SYMBOLS | Millimeters | | |
|---------|-------------|------|------|
| | MIN | NOM | MAX |
| A | 2.20 | 2.30 | 2.40 |
| A1 | 0.90 | 1.20 | 1.50 |
| B1 | 0.40 | 0.60 | 0.80 |
| B2 | 0.60 | 0.85 | 1.05 |
| c | 0.40 | 0.50 | 0.60 |
| c1 | 0.40 | 0.50 | 0.60 |
| D | 6.40 | 6.60 | 6.80 |
| D1 | 4.80 | 5.20 | 5.50 |
| E | 6.70 | 7.00 | 7.30 |
| E1 | 5.40 | 5.60 | 5.80 |
| E2 | 1.30 | 1.50 | 1.70 |
| e | ---- | 2.30 | ---- |
| F | 7.00 | 8.30 | 9.60 |

1. All dimensions are in millimeters.
2. Dimensions do not include mold protrusions.

Marking Information: TO-251

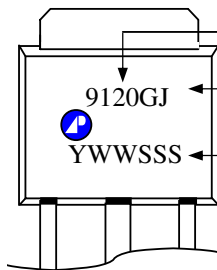

Product: AP9120

Package Code

GJ = RoHS-compliant halogen-free TO-251

Date Code (YWWSSS)

Y : Last digit of the year

WW : Work week

SSS : Lot code sequence