

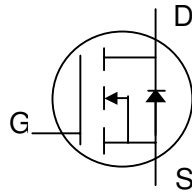

N-channel Enhancement-mode Power MOSFET

- Simple Drive Requirement**
- Low On-resistance**
- Fast Switching Performance**
- RoHS-compliant, halogen-free**



BV_{DSS}	80V
$R_{DS(ON)}$	13mΩ
I_D	75A

Description

Advanced Power MOSFETs from APEC provide the designer with the best combination of fast switching, low on-resistance and cost-effectiveness.

The AP85T08GS-HF-3 is in the TO-263 package, which is widely used for commercial and industrial surface-mount applications, and is well suited for low voltage applications such as DC/DC converters.

The AP85T08GP-HF-3 is in the TO-220 through-hole package which is used where a small PCB footprint or an attached heatsink is required.

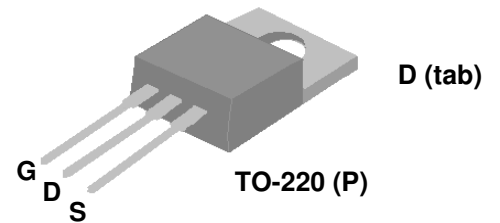
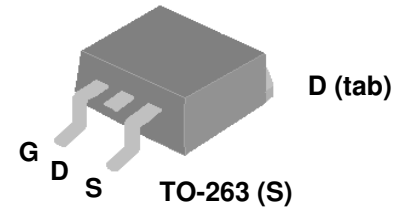

Absolute Maximum Ratings

Symbol	Parameter	Rating	Units
V_{DS}	Drain-Source Voltage	80	V
V_{GS}	Gate-Source Voltage	±20	V
I_D at $T_C=25\text{ }^\circ\text{C}$	Continuous Drain Current ³	75	A
I_D at $T_C=100\text{ }^\circ\text{C}$	Continuous Drain Current ³	48	A
I_{DM}	Pulsed Drain Current ¹	260	A
E_{AS}	Single Pulse Avalanche Energy ³	450	mJ
I_{AR}	Avalanche Current	30	A
P_D at $T_C=25\text{ }^\circ\text{C}$	Total Power Dissipation	138	W
	Linear Derating Factor	1.11	W/°C
T_{STG}	Storage Temperature Range	-55 to 150	°C
T_J	Operating Junction Temperature Range	-55 to 150	°C

Thermal Data

Symbol	Parameter	Value	Units
Rthj-c	Maximum Thermal Resistance, Junction-case	0.9	°C/W
Rthj-a	Maximum Thermal Resistance, Junction-ambient (PCB mount) ⁴	40	°C/W
Rthj-a	Maximum Thermal Resistance, Junction-ambient	62	°C/W

Ordering Information

AP85T08GS-HF-3TR : RoHS-compliant halogen-free TO-263, shipped on tape and reel (800 pcs/reel)

AP85T08GP-HF-3TB : RoHS-compliant halogen-free TO-220, shipped in tubes (50pcs/tube)



Electrical Specifications at $T_j=25^\circ\text{C}$ (unless otherwise specified)

Symbol	Parameter	Test Conditions	Min.	Typ.	Max.	Units
BV_{DSS}	Drain-Source Breakdown Voltage	$V_{GS}=0V, I_D=1\text{mA}$	80	-	-	V
$R_{DS(ON)}$	Static Drain-Source On-Resistance ²	$V_{GS}=10V, I_D=45A$	-	-	13	m Ω
$V_{GS(th)}$	Gate Threshold Voltage	$V_{DS}=V_{GS}, I_D=250\mu A$	1	-	3	V
g_{fs}	Forward Transconductance	$V_{DS}=10V, I_D=45A$	-	70	-	S
I_{DSS}	Drain-Source Leakage Current	$V_{DS}=80V, V_{GS}=0V$	-	-	10	μA
	Drain-Source Leakage Current ($T_j=150^\circ\text{C}$)	$V_{DS}=64V, V_{GS}=0V$	-	-	100	μA
I_{GSS}	Gate-Source Leakage	$V_{GS}=\pm 20V$	-	-	± 100	nA
Q_g	Total Gate Charge ²	$I_D=45A$	-	63	100	nC
Q_{gs}	Gate-Source Charge	$V_{DS}=64V$	-	23	-	nC
Q_{gd}	Gate-Drain ("Miller") Charge	$V_{GS}=4.5V$	-	38	-	nC
$t_{d(on)}$	Turn-on Delay Time ²	$V_{DS}=40V$	-	30	-	ns
t_r	Rise Time	$I_D=45A$	-	100	-	ns
$t_{d(off)}$	Turn-off Delay Time	$R_G=10\Omega, V_{GS}=10V$	-	144	-	ns
t_f	Fall Time	$R_D=0.89\Omega$	-	173	-	ns
C_{iss}	Input Capacitance	$V_{GS}=0V$	-	6300	10080	pF
C_{oss}	Output Capacitance	$V_{DS}=25V$	-	670	-	pF
C_{riss}	Reverse Transfer Capacitance	$f=1.0\text{MHz}$	-	350	-	pF
R_g	Gate Resistance	$f=1.0\text{MHz}$	-	1.1	1.7	Ω

Source-Drain Diode

Symbol	Parameter	Test Conditions	Min.	Typ.	Max.	Units
V_{SD}	Forward On Voltage ²	$I_S=45A, V_{GS}=0V$	-	-	1.3	V
t_{rr}	Reverse Recovery Time ²	$I_S=20A, V_{GS}=0V$	-	47	-	ns
Q_{rr}	Reverse Recovery Charge	$di/dt=100A/\mu s$	-	86	-	nC

Notes:

1. Pulse width limited by maximum junction temperature.
2. Pulse test - pulse width $\leq 300\mu s$, duty cycle $\leq 2\%$
3. Starting $T_j = 25^\circ\text{C}$, $V_{DD}=30V$, $L=1\text{mH}$, $R_G=25\Omega$, $I_{AS}=30A$.
4. Surface mounted on 1 in2 copper pad of FR4 board

THIS PRODUCT IS SENSITIVE TO ELECTROSTATIC DISCHARGE, PLEASE HANDLE WITH CAUTION.

USE OF THIS PRODUCT AS A CRITICAL COMPONENT IN LIFE SUPPORT OR OTHER SIMILAR SYSTEMS IS NOT AUTHORIZED.

APEC DOES NOT ASSUME ANY LIABILITY ARISING OUT OF THE APPLICATION OR USE OF ANY PRODUCT OR CIRCUIT DESCRIBED HEREIN; NEITHER DOES IT CONVEY ANY LICENSE UNDER ITS PATENT RIGHTS, NOR THE RIGHTS OF OTHERS.

APEC RESERVES THE RIGHT TO MAKE CHANGES WITHOUT FURTHER NOTICE TO ANY PRODUCTS HEREIN TO IMPROVE RELIABILITY, FUNCTION OR DESIGN.



Typical Electrical Characteristics

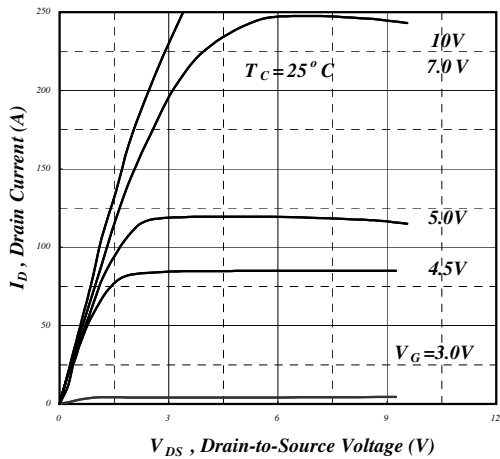

Fig 1. Typical Output Characteristics

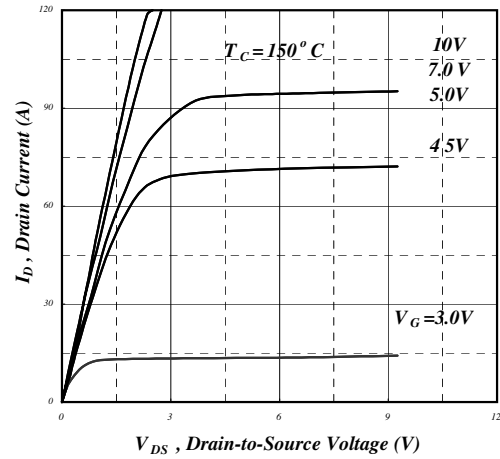

Fig 2. Typical Output Characteristics

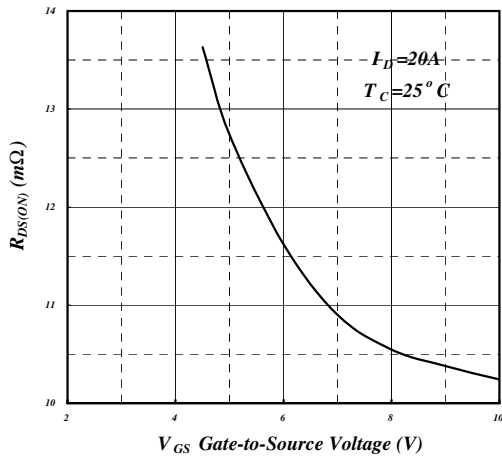

Fig 3. On-Resistance vs. Gate Voltage

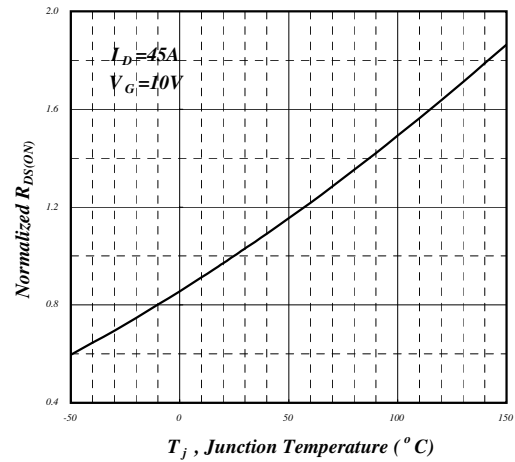

Fig 4. Normalized On-Resistance vs. Junction Temperature

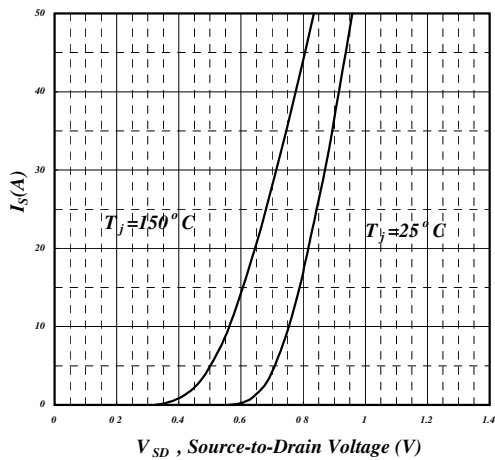

Fig 5. Forward Characteristic of Reverse Diode

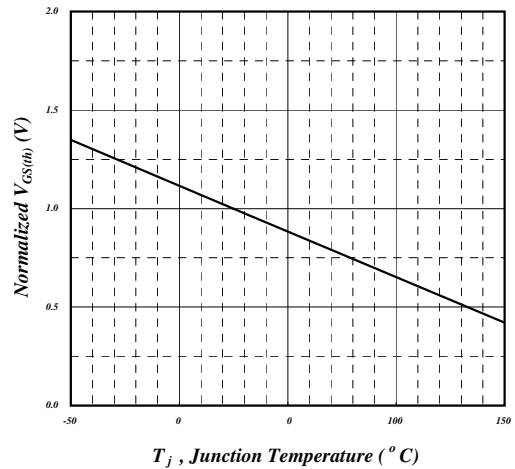

Fig 6. Gate Threshold Voltage vs. Junction Temperature



Typical Electrical Characteristics (cont.)

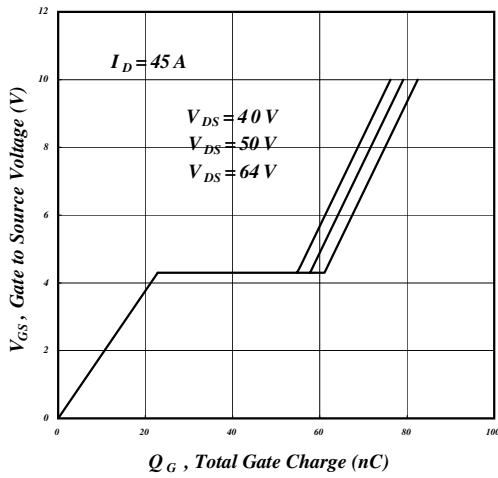

Fig 7. Gate Charge Characteristics

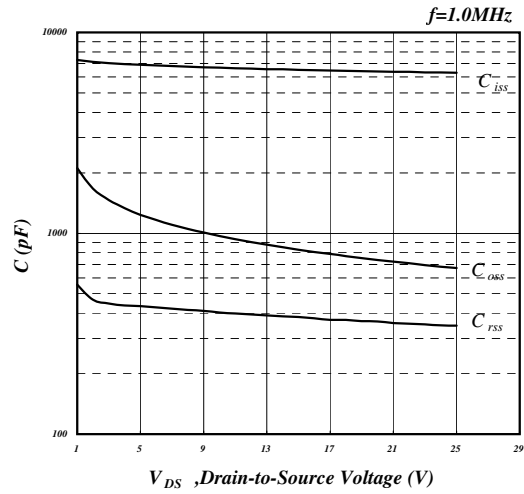

Fig 8. Typical Capacitance Characteristics

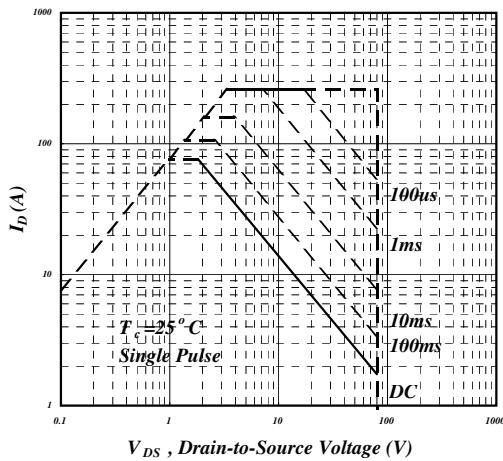

Fig 9. Maximum Safe Operating Area

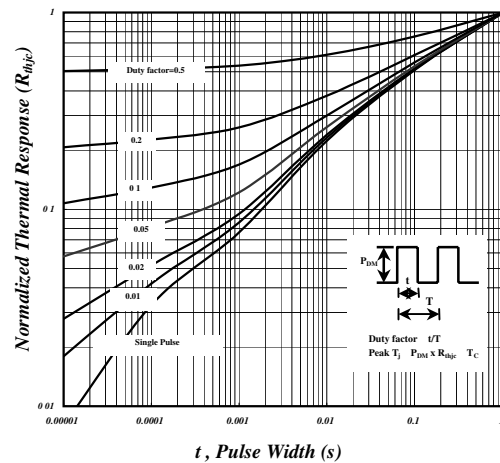

Fig 10. Effective Transient Thermal Impedance

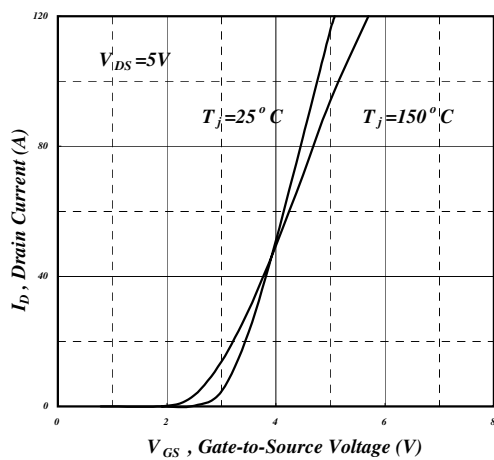

Fig 11. Transfer Characteristics

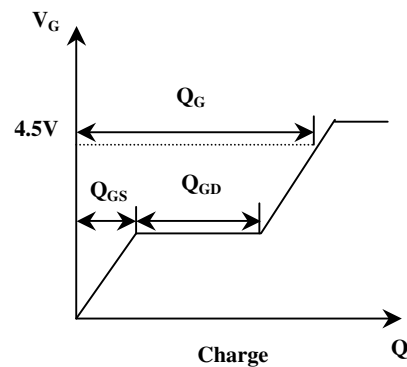
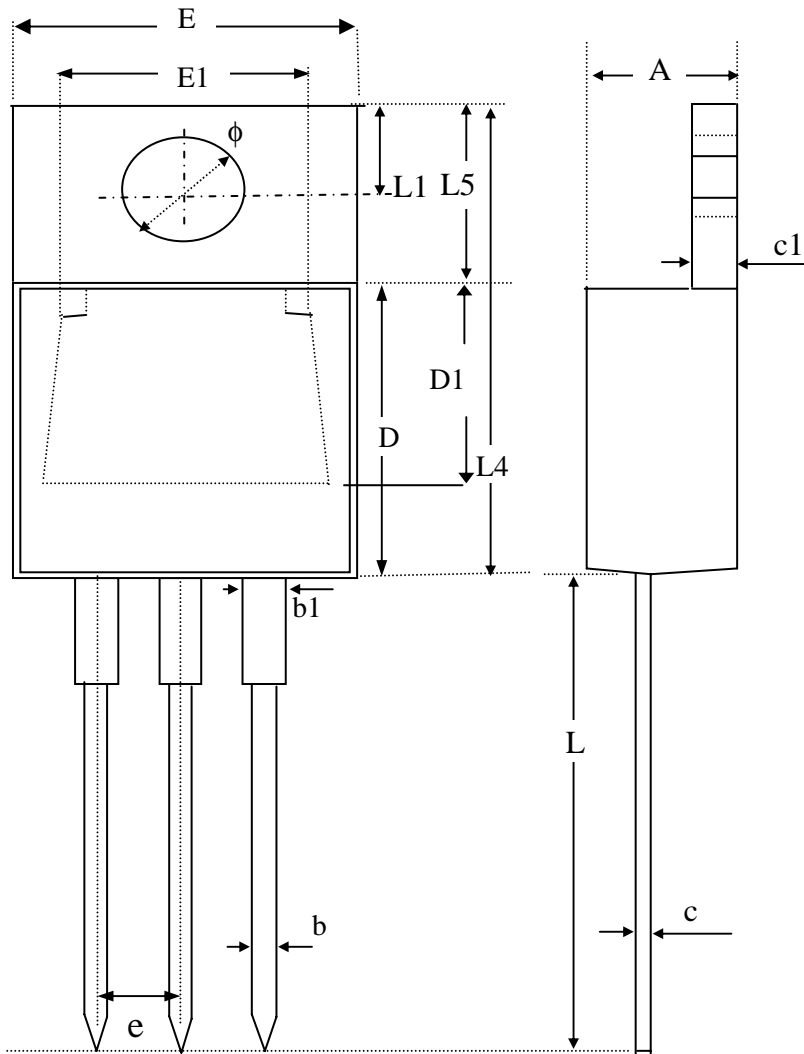

Fig 12. Gate Charge Waveform



Package Dimensions: TO-220



SYMBOLS	Millimeters		
	MIN	NOM	MAX
A	4.40	4.60	4.80
b	0.76	0.88	1.00
D	8.60	8.80	9.00
c	0.36	0.43	0.50
E	9.80	10.10	10.40
L4	14.70	15.00	15.30
L5	6.20	6.40	6.60
D1	5.10 REF.		
c1	1.25	1.35	1.45
b1	1.17	1.32	1.47
L	13.25	13.75	14.25
e	2.54 REF.		
L1	2.60	2.75	2.89
phi	3.71	3.84	3.96
E1	7.4 REF.		

1. All dimensions are in millimeters.
2. Dimensions do not include mold protrusions.

Marking Information: TO-220

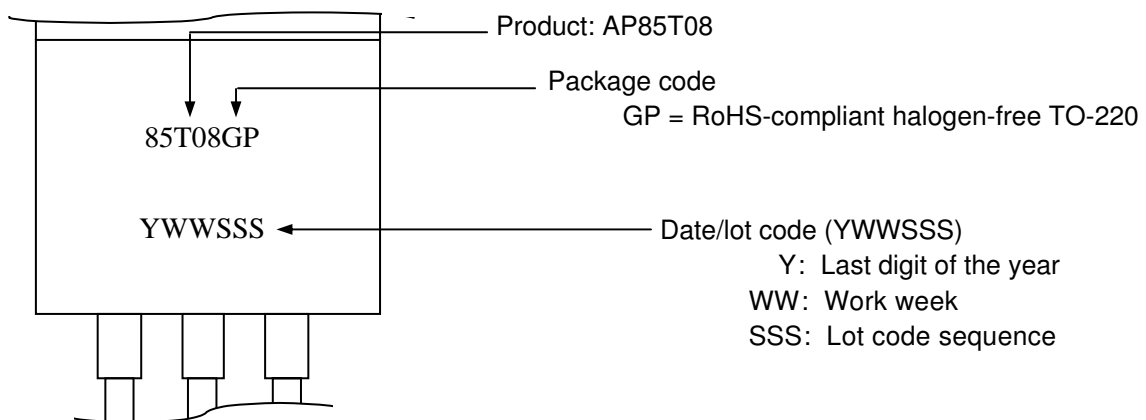



Package Dimensions: TO-263

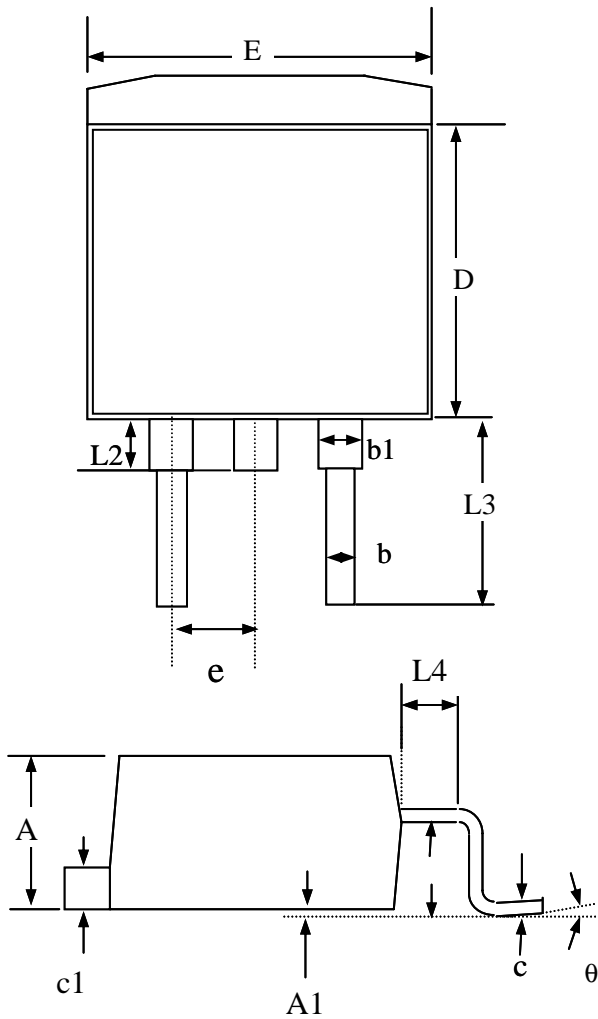

SYMBOLS	Millimeters		
	MIN	NOM	MAX
A	4.25	4.75	5.20
A1	0.00	0.15	0.30
A2	2.20	2.45	2.70
b	0.70	0.90	1.10
b1	1.07	1.27	1.47
c	0.30	0.45	0.60
c1	1.15	1.30	1.45
D	8.30	8.90	9.40
E	9.70	10.10	10.50
e	2.04	2.54	3.04
L2	-----	1.50	-----
L3	4.50	4.90	5.30
L4	-----	1.50	----

1. All dimensions are in millimeters.
2. Dimensions do not include mold protrusions.

Marking Information: TO-263

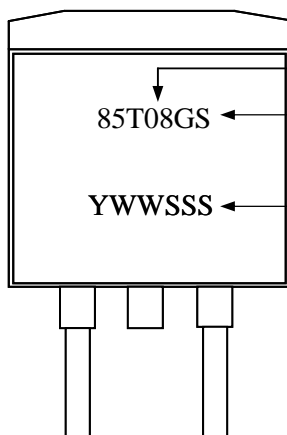

Product: AP85T08
 Package code:
 GS = RoHS-compliant halogen-free TO-263
 Date Code (YWWSSS)
 Y : Last digit of the year
 WW : Work week
 SSS : Lot code sequence