

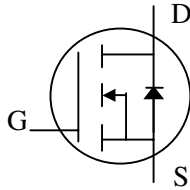

N-channel Enhancement-mode Power MOSFET

- Low Gate Charge
- Simple Drive Requirement
- Fast Switching Performance
- RoHS-compliant, halogen-free



BV_{DS}	75V
$R_{DS(ON)}$	11mΩ
I_D	80A

Description

Advanced Power MOSFETs from APEC provide the designer with the best combination of fast switching, low on-resistance and cost-effectiveness.

The AP75N07AGP-HF-3 is in the TO-220 package, which is widely used for commercial and industrial applications, and is well-suited for low-voltage applications such as DC-DC converters, motor drives and high-current high-speed switching circuits.

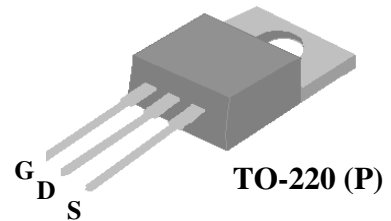

Absolute Maximum Ratings

Symbol	Parameter	Rating	Units
V_{DS}	Drain-Source Voltage	75	V
V_{GS}	Gate-Source Voltage	±30	V
I_D at $T_C=25^\circ\text{C}$	Continuous Drain Current ⁴	80	A
I_D at $T_C=100^\circ\text{C}$	Continuous Drain Current	70	A
I_{DM}	Pulsed Drain Current ¹	320	A
P_D at $T_C=25^\circ\text{C}$	Total Power Dissipation	300	W
E_{AS}	Single Pulse Avalanche Energy ³	450	mJ
T_{STG}	Storage Temperature Range	-55 to 175	°C
T_J	Operating Junction Temperature Range	-55 to 175	°C

Thermal Data

Symbol	Parameter	Value	Units
Rthj-c	Maximum Thermal Resistance, Junction-case	0.5	°C/W
Rthj-a	Maximum Thermal Resistance, Junction-ambient	62	°C/W

Ordering Information

AP75N07AGP-HF-3TB

RoHS-compliant halogen-free TO-220, shipped in tubes



Electrical Specifications at $T_j=25^\circ\text{C}$ (unless otherwise specified)

Symbol	Parameter	Test Conditions	Min.	Typ.	Max.	Units
BV_{DSS}	Drain-Source Breakdown Voltage	$V_{GS}=0V, I_D=1\text{mA}$	75	-	-	V
$R_{DS(ON)}$	Static Drain-Source On-Resistance ²	$V_{GS}=10V, I_D=40A$	-	-	11	m Ω
$V_{GS(th)}$	Gate Threshold Voltage	$V_{DS}=V_{GS}, I_D=250\mu A$	2	-	4	V
g_{fs}	Forward Transconductance	$V_{DS}=15V, I_D=40A$	-	78	-	S
I_{DSS}	Drain-Source Leakage Current	$V_{DS}=75V, V_{GS}=0V$	-	-	10	μA
	Drain-Source Leakage Current ($T_j=125^\circ\text{C}$)	$V_{DS}=60V, V_{GS}=0V$	-	-	250	μA
I_{GSS}	Gate-Source Leakage	$V_{GS}=\pm 30V, V_{DS}=0V$	-	-	± 100	nA
Q_g	Total Gate Charge ²	$I_D=40A$	-	100	160	nC
Q_{gs}	Gate-Source Charge	$V_{DS}=60V$	-	13	-	nC
Q_{gd}	Gate-Drain ("Miller") Charge	$V_{GS}=10V$	-	47	-	nC
$t_{d(on)}$	Turn-on Delay Time ²	$V_{DD}=40V$	-	15	-	ns
t_r	Rise Time	$I_D=30A$	-	83	-	ns
$t_{d(off)}$	Turn-off Delay Time	$R_G=3.3\Omega, V_{GS}=10V$	-	67	-	ns
t_f	Fall Time	$R_D=1.33\Omega$	-	86	-	ns
C_{iss}	Input Capacitance	$V_{GS}=0V$	-	3220	5150	pF
C_{oss}	Output Capacitance	$V_{DS}=25V$	-	650	-	pF
C_{riss}	Reverse Transfer Capacitance	$f=1.0\text{MHz}$	-	220	-	pF
R_g	Gate Resistance	$f=1.0\text{MHz}$	-	3.3	5	Ω

Source-Drain Diode

Symbol	Parameter	Test Conditions	Min.	Typ.	Max.	Units
V_{SD}	Forward On Voltage ²	$T_j=25^\circ\text{C}, I_S=40A, V_{GS}=0V$	-	-	1.5	V
t_{rr}	Reverse Recovery Time ²	$I_S=40A, V_{GS}=0V$	-	80	-	ns
Q_{rr}	Reverse Recovery Charge	$di/dt=100A/\mu s$	-	235	-	nC

Notes:

1. Pulse width limited by maximum junction temperature.
2. Pulse test
3. Starting $T_j=25^\circ\text{C}$, $V_{DD}=50V$, $L=1\text{mH}$, $R_G=25\Omega$, $I_{AS}=30A$.
4. Package limitation current is 80A, calculated continuous current based on maximum allowable junction temperature is 108A.

THIS PRODUCT IS SENSITIVE TO ELECTROSTATIC DISCHARGE, PLEASE HANDLE WITH CAUTION.

USE OF THIS PRODUCT AS A CRITICAL COMPONENT IN LIFE SUPPORT OR OTHER SIMILAR SYSTEMS IS NOT AUTHORIZED.

APEC DOES NOT ASSUME ANY LIABILITY ARISING OUT OF THE APPLICATION OR USE OF ANY PRODUCT OR CIRCUIT DESCRIBED HEREIN; NEITHER DOES IT CONVEY ANY LICENSE UNDER ITS PATENT RIGHTS, NOR THE RIGHTS OF OTHERS.

APEC RESERVES THE RIGHT TO MAKE CHANGES WITHOUT FURTHER NOTICE TO ANY PRODUCTS HEREIN TO IMPROVE RELIABILITY, FUNCTION OR DESIGN.



Typical Electrical Characteristics

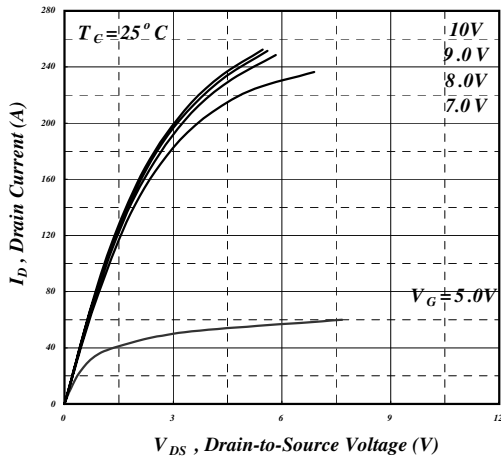

Fig 1. Typical Output Characteristics

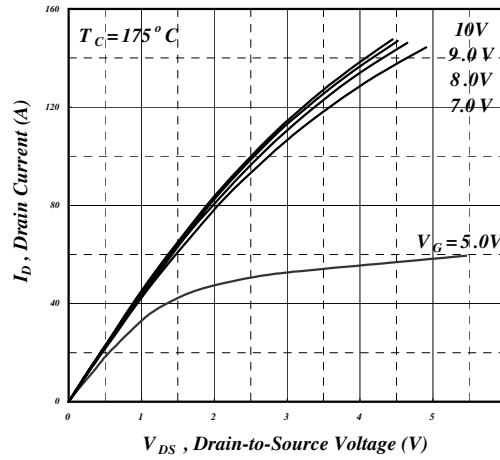

Fig 2. Typical Output Characteristics

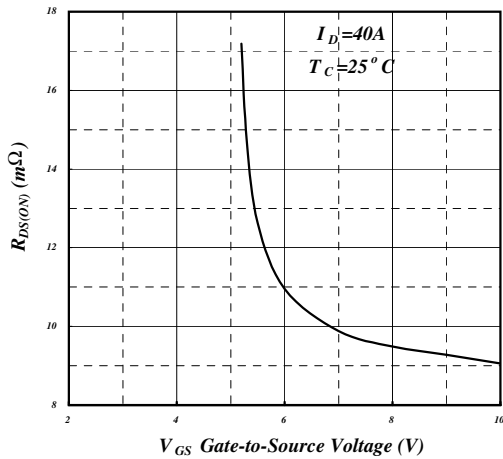

Fig 3. On-Resistance vs. Gate Voltage

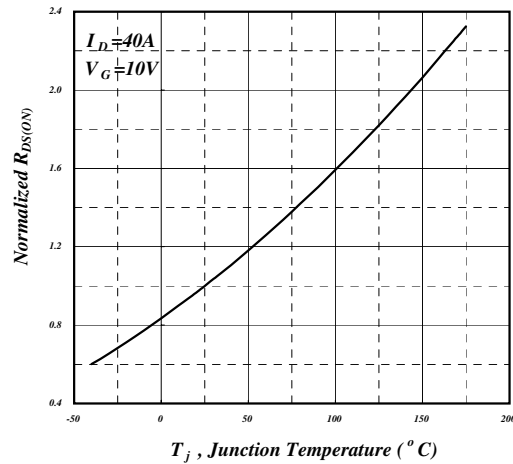

Fig 4. Normalized On-Resistance vs. Junction Temperature

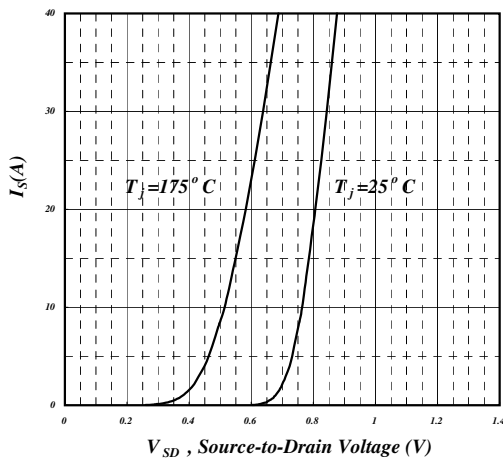

Fig 5. Forward Characteristic of the Reverse Diode

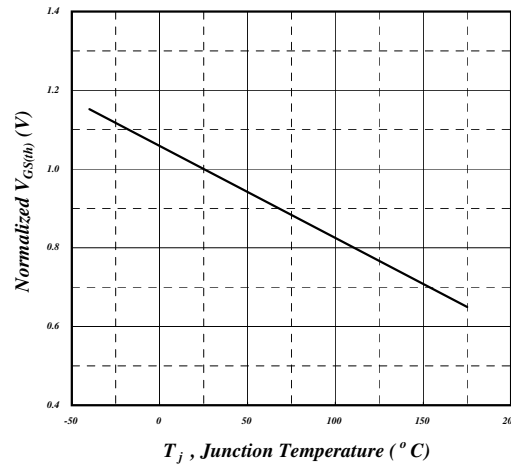

Fig 6. Gate Threshold Voltage vs. Junction Temperature



Typical Electrical Characteristics (cont.)

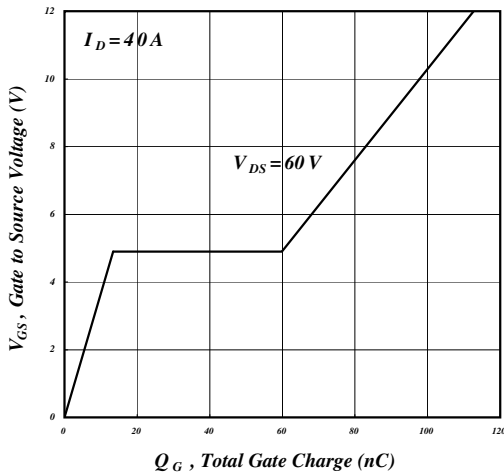

Fig 7. Gate Charge Characteristics

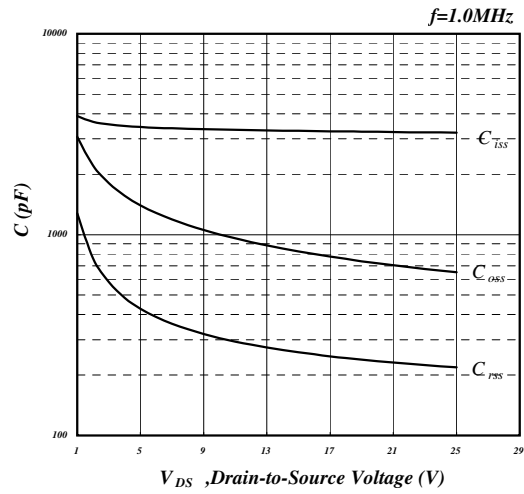

Fig 8. Typical Capacitance Characteristics

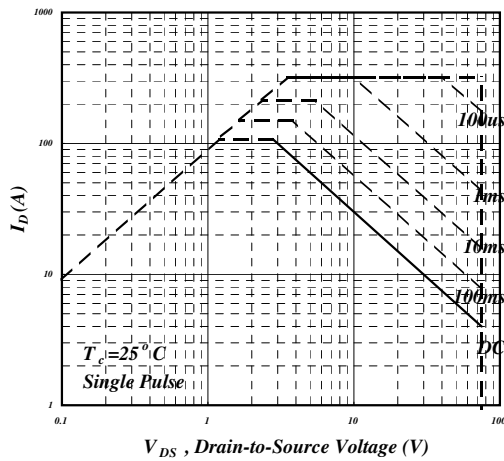

Fig 9. Maximum Safe Operating Area

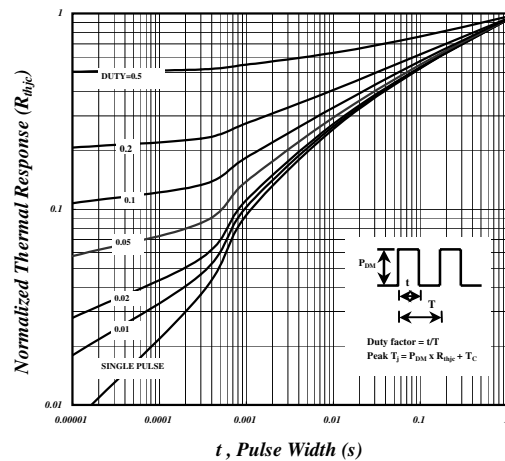

Fig 10. Effective Transient Thermal Impedance

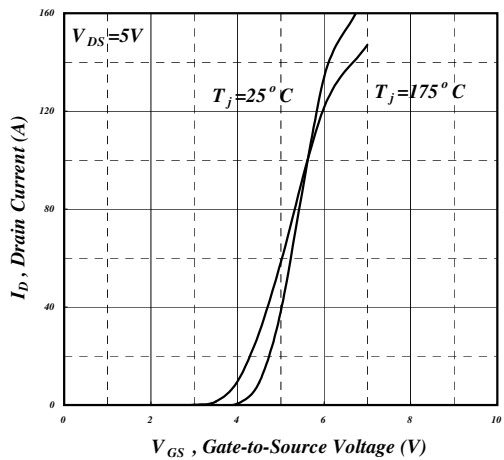

Fig 11. Transfer Characteristics

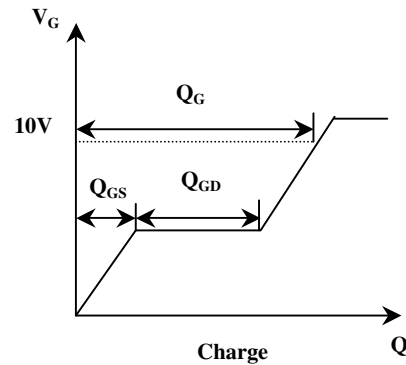
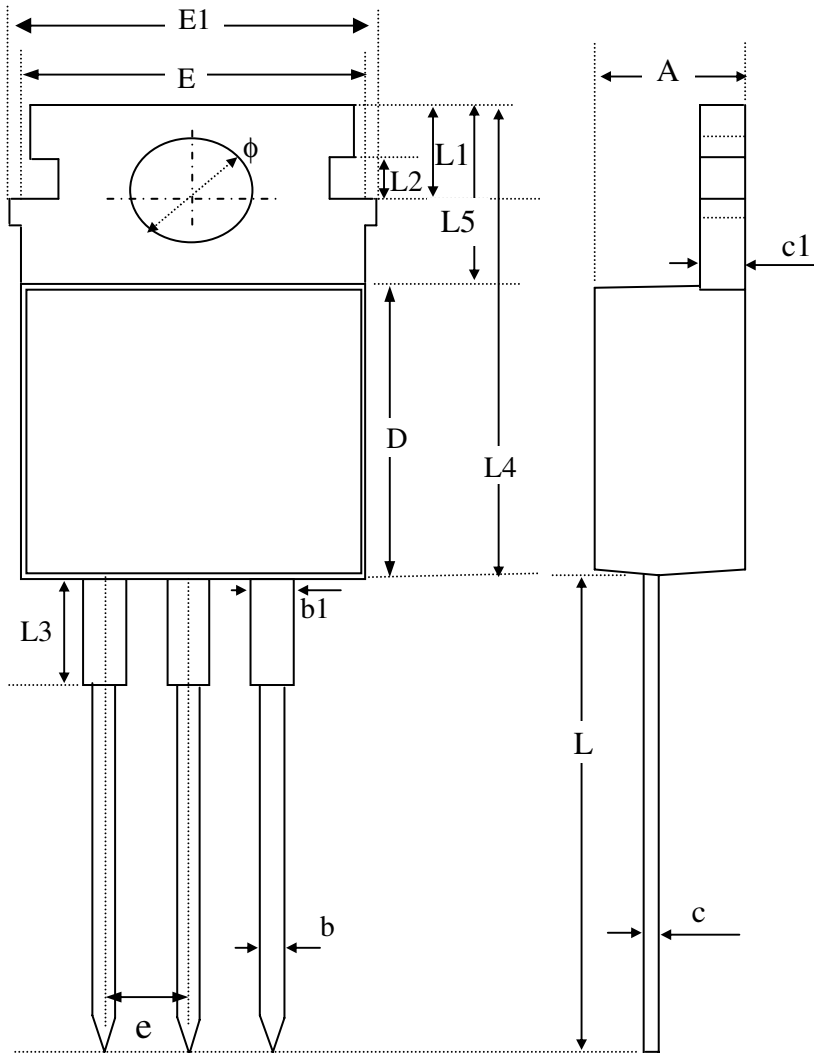

Fig 12. Gate Charge Waveform



Package Dimensions: TO-220



SYMBOLS	Millimeters		
	MIN	NOM	MAX
A	4.25	4.48	4.70
b	0.65	0.80	0.90
b1	1.15	1.38	1.60
c	0.40	0.50	0.60
c1	1.00	1.20	1.40
E	9.70	10.00	10.40
E1	---	---	11.50
e	----	2.54	----
L	12.70	13.60	14.50
L1	2.60	2.80	3.00
L2	1.00	1.40	1.80
L3	2.6	3.10	3.6
L4	14.70	15.50	16
L5	6.30	6.50	6.70
phi	3.50	3.60	3.70
D	8.40	8.90	9.40

1. All dimensions are in millimeters.
2. Dimensions do not include mold protrusions.

Marking Information: TO-220

