

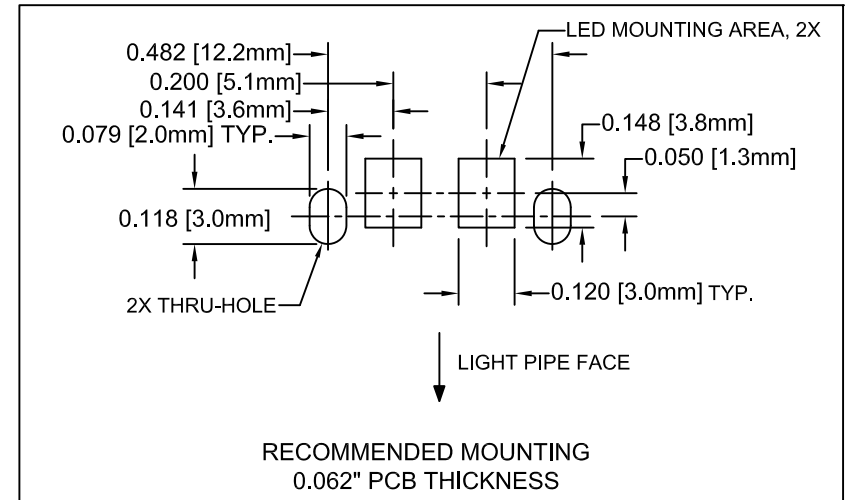

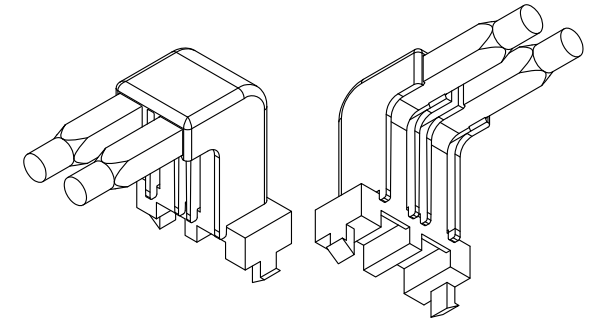

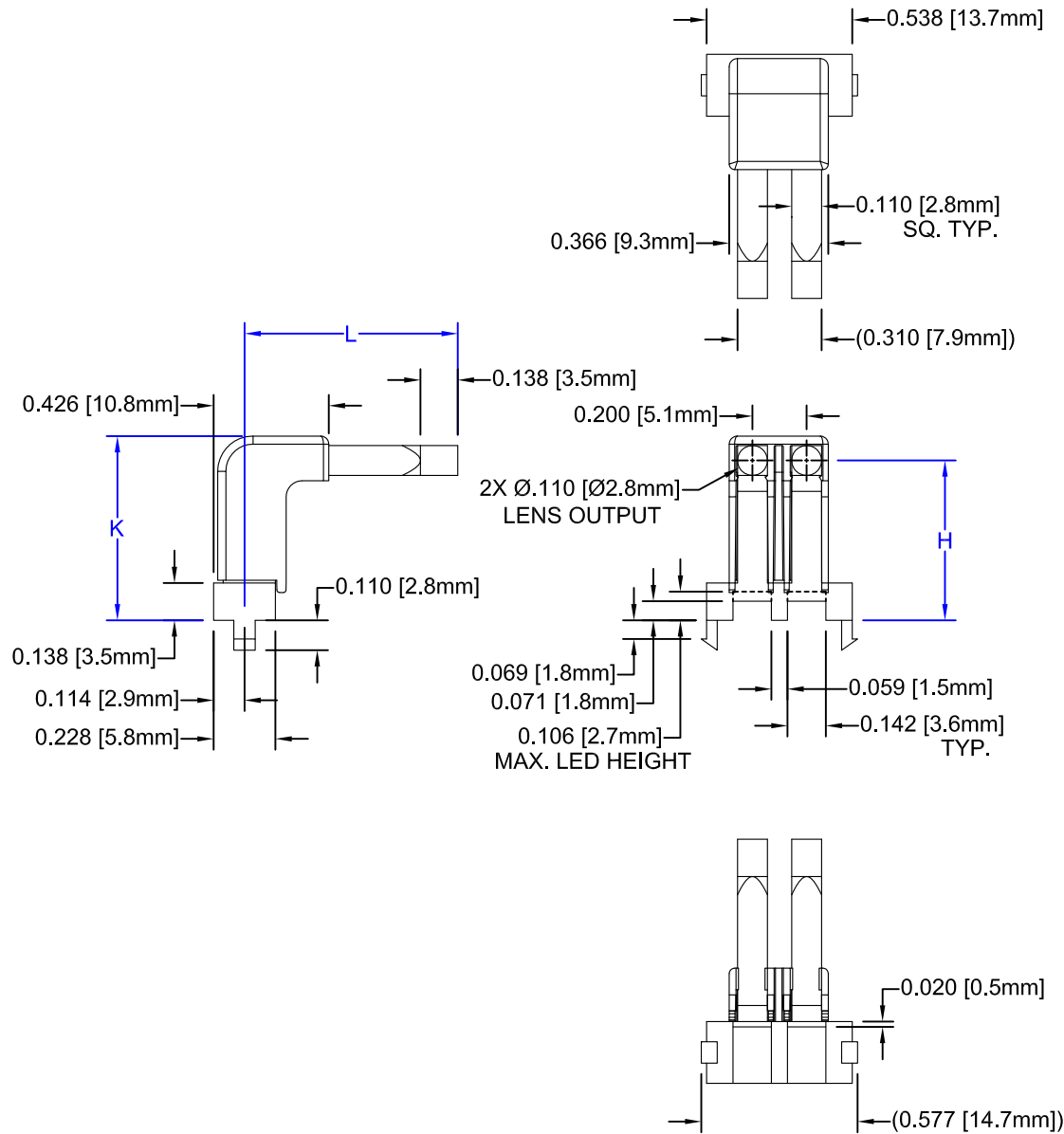





ITEM	Q'TY	PART NUMBER	PART DESCRIPTION
1	1	LPR2-XXX-XXX	Surface Mount Right Angle Light Pipe, 2.8mm, 2 Station. See Table on 2nd Page
2	1	RLPH2-XXX	LPR Housing, 2 Station, White. See Table on 2nd Page

REV.	DESCRIPTION	DATE	APPROVED
A	Engineering Release	11/06/09	T. Y.
B	Added Overall Height "K" Dim	03/04/11	T. Y.
C	Added Overall Snap Height Dimension	08/15/12	T. Y.



STANDARD TOLERANCE (UNLESS OTHERWISE SPECIFIED)		BIVAR®	
DECIMALS	ANGULAR	4 THOMAS, IRVINE, CA. 92618	
.X ±.1	X° ± 1°	TEL: (949) 951-8808 FAX: (949) 951-3974	
.XX ±.01		TITLE: RIGHT ANGLE LIGHT PIPE, 2.8MM, 2 STATION	
.XXX ±.010		PART NO: RLP2-XXX-XXX	
DESIGNED: Raffy Paje	DATE: 11/06/09	REVISION: C	
CHECKED: T. Yin	DATE: 11/06/09	CAGE CODE : 32559	SHEET # 1 OF 2
CAD GENERATED DOCUMENT, DO NOT MEASURE DRAWING.			

REV.	DESCRIPTION	DATE	APPROVED
	SEE SHEET #1		

RLP2-XXX-XXX						
ASSY P/N	H	L	K	LPR2-XXX-XXX	RLPH2-XXX	FIGURE
RLP2-200-500	0.197 [5.0mm]	0.551 [14.0mm]	0.287 [7.3mm]	LPR2-200-500	RLPH2-200	
RLP2-200-650		0.669 [17.0mm]		LPR2-200-650	RLPH2-200	
RLP2-200-800		0.787 [20.0mm]		LPR2-200-800	RLPH2-200	
RLP2-400-500	0.394 [10.0mm]	0.551 [14.0mm]	0.484 [12.3mm]	LPR2-400-500	RLPH2-400	
RLP2-400-650		0.669 [17.0mm]		LPR2-400-650	RLPH2-400	
RLP2-400-800		0.787 [20.0mm]		LPR2-400-800	RPH2-400	
RLP2-600-500	0.591 [15.0mm]	0.551 [14.0mm]	0.681 [17.3mm]	LPR2-600-500	RLPH2-600	
RLP2-600-650		0.669 [17.0mm]		LPR2-600-650	RLPH2-600	
RLP2-600-800		0.787 [20.0mm]		LPR2-600-800	RLPH2-600	

STANDARD TOLERANCE (UNLESS OTHERWISE SPECIFIED)		BIVAR [®] 4 THOMAS, IRVINE, CA. 92618 TEL: (949) 951-8808 FAX: (949) 951-3974	
DECIMALS	ANGULAR		
.X ±.1	X° ± 1°		TITLE: RIGHT ANGLE LIGHT PIPE, 2.8MM, 2 STATION
.XX ±.01			PART NO: RLP2-XXX-XXX
.XXX ±.010			REVISION: C
DESIGNED: Raffy Paje	DATE: 11/06/09	CAGE CODE : 32559	SHEET # 2 OF 2
CHECKED: T. Yin	DATE: 11/06/09	CAD GENERATED DOCUMENT, DO NOT MEASURE DRAWING.	