

CZRERT52C2 Thru CZRERT52C39

Voltage 2 to 39 Volts

Power 150 mWatts

RoHS Device

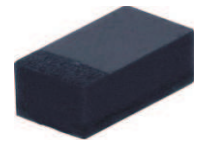

Features

- 150mW Power Dissipation.
- High Voltages from 2 ~ 39 V.
- Designed for mounting on small surface.
- Extremely thin/leadless package.
- Pb free product.

Mechanical data

- Case: 0503/SOD-723F Standard package Molded plastic.
- Terminals: Gold plated, solderable per MIL-STD-750,method 2026.
- Polarity: Indicated by cathode band.
- Weight: 0.0011 gram(approx.).

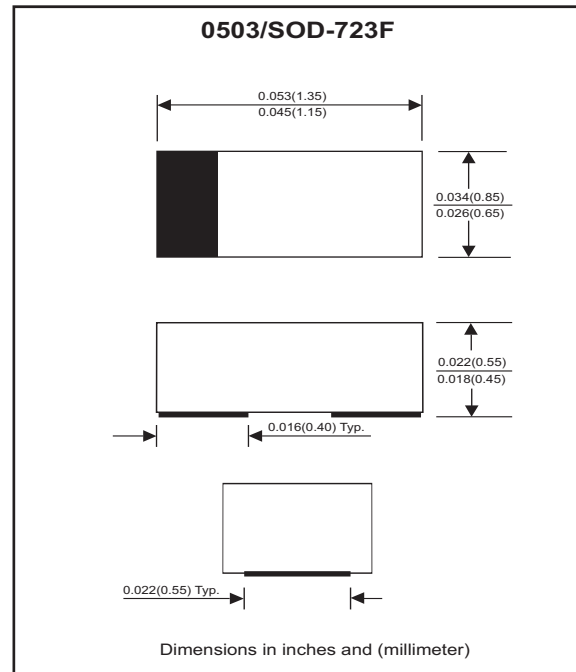

Maximum Rating AND Electrical Characteristics

Parameter	Symbol	Value	Unit
Maximum Forward Voltage Drop at $I_F = 10 \text{ mA}$	V_F	0.9	V
Maximum Power Dissipation at 25 C°	P_D	150	mW
Forward current , surge peak 8.3 ms single half sine-wave superimposed on rate load(JEDEC method)	I_{FSM}	2.0	A
Peak ESD voltage capability (IEC 61000-4-2)	V_{PV}	8	kV
Operating Junction and Storage Temperature Range	T_J	-55 to +125	$^\circ\text{C}$

Electrical Characteristics (TA=25 °C)

Part Number	Marking Code	Zener Voltage			Operating resistance		Rising operating Resistance		Reverse current	
		V _Z (V)			ZZT(Ohm)		ZZK(Ohm)		IR(uA)	
		Min	Max	I _Z (mA)	Max	I _Z (mA)	Max	I _Z (mA)	Max	V _R (V)
CZRERT52C2	Z0	1.90	2.10	5	100	5	600	1	100	1
CZRERT52C2V2	Z1	2.09	2.31	5	100	5	600	1	100	1
CZRERT52C2V4	Z2	2.28	2.52	5	85	5	600	1	100	1
CZRERT52C2V7	Z3	2.57	2.84	5	83	5	500	1	75	1
CZRERT52C3	Z4	2.85	3.15	5	95	5	500	1	50	1
CZRERT52C3V3	Z5	3.14	3.47	5	95	5	500	1	25	1
CZRERT52C3V6	Z6	3.42	3.78	5	95	5	500	1	15	1
CZRERT52C3V9	Z7	3.71	4.10	5	95	5	500	1	10	1
CZRERT52C4V3	Z8	4.09	4.52	5	95	5	500	1	5	1
CZRERT52C4V7	Z9	4.47	4.94	5	78	5	500	1	5	2
CZRERT52C5V1	ZA	4.85	5.36	5	60	5	480	1	0.1	0.8
CZRERT52C5V6	ZB	5.32	5.88	5	40	5	400	1	0.1	1
CZRERT52C6V2	ZC	5.89	6.51	5	10	5	200	1	0.1	2
CZRERT52C6V8	ZE	6.46	7.14	5	8	5	150	1	0.1	3
CZRERT52C7V5	ZF	7.13	7.88	5	7	5	50	1	0.1	5
CZRERT52C8V2	ZG	7.79	8.61	5	7	5	50	1	0.1	6
CZRERT52C9V1	ZH	8.65	9.56	5	10	5	50	1	0.1	7
CZRERT52C10	ZJ	9.50	10.50	5	15	5	70	1	0.1	7.5
CZRERT52C11	ZK	10.45	11.55	5	20	5	70	1	0.1	8.5
CZRERT52C12	ZM	11.40	12.60	5	20	5	90	1	0.1	9
CZRERT52C13	ZN	12.35	13.65	5	25	5	110	1	0.1	10
CZRERT52C15	ZP	14.25	15.75	5	30	5	110	1	0.1	11
CZRERT52C16	ZQ	15.20	16.80	5	40	5	170	1	0.1	12
CZRERT52C18	ZR	17.10	18.90	5	50	5	170	1	0.1	14
CZRERT52C20	ZS	19.00	21.00	5	50	5	220	1	0.1	15
CZRERT52C22	ZT	20.90	23.10	5	55	5	220	1	0.1	17
CZRERT52C24	ZU	22.80	25.20	5	80	5	220	1	0.1	18
CZRERT52C27	ZV	25.65	28.35	5	80	5	250	1	0.1	20
CZRERT52C30	ZW	28.50	31.50	5	80	5	250	1	0.1	23
CZRERT52C33	ZX	31.35	34.65	5	80	5	250	1	0.1	25
CZRERT52C36	ZY	34.20	37.80	5	90	5	250	1	0.1	27
CZRERT52C39	ZZ	37.05	40.95	5	90	5	300	1	0.1	29

RATING AND CHARACTERISTIC CURVES (CZRERT52C2 Thru CZRERT52C39)

Fig.1 TEMPERATURE COEFFICIENTS

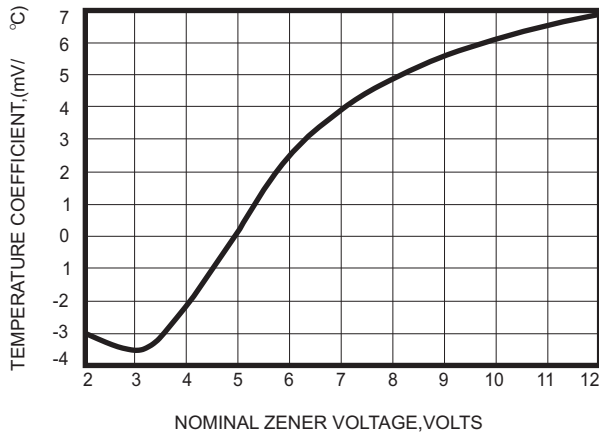

Fig.2 TEMPERATURE COEFFICIENTS

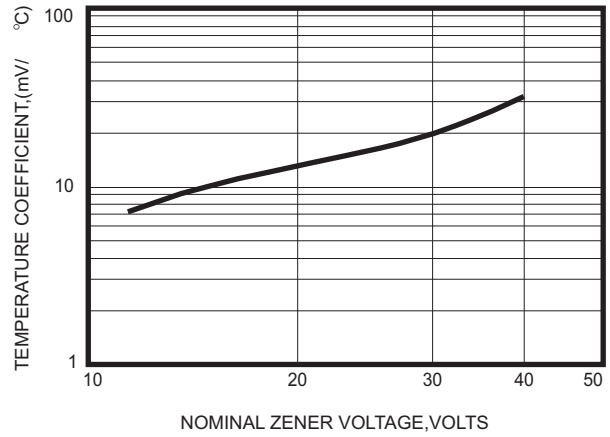

Fig.3 EFFECT OF ZENER VOLTAGE ON ZENER IMPEDANCE

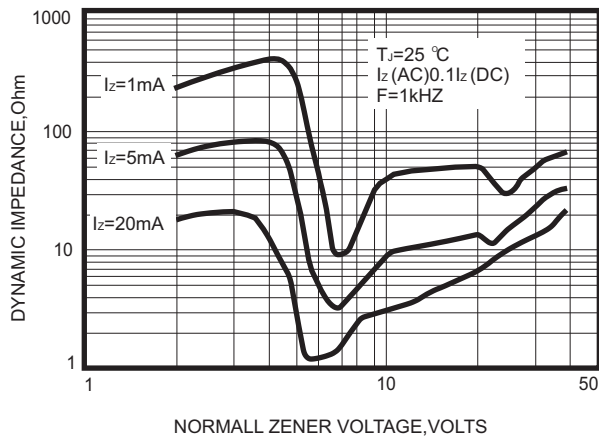

Fig.4 TYPICAL FORWARD VOLTAGE

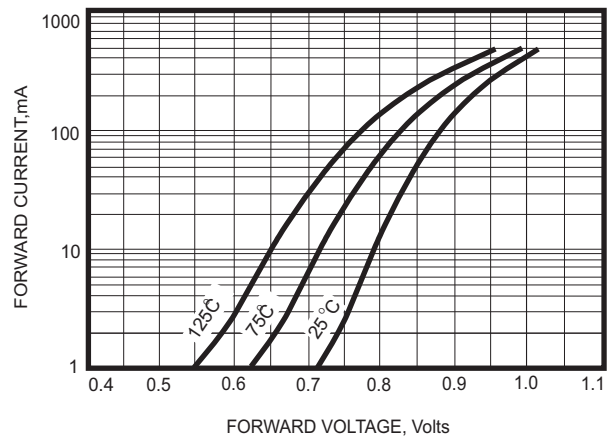

Fig.5 TYPICAL LEAKAGE CURRENT

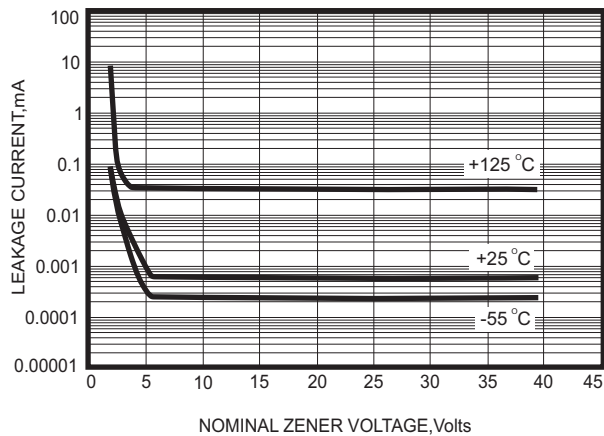
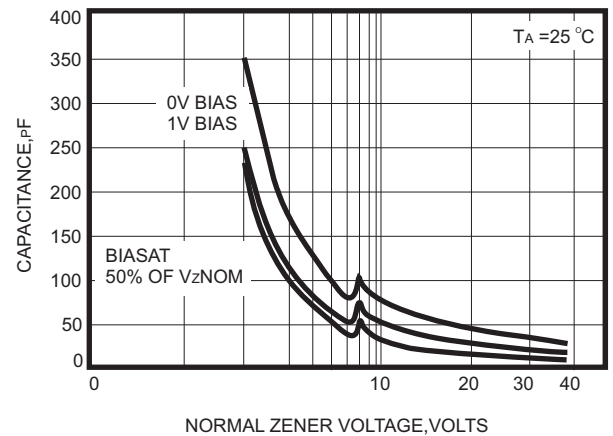

Fig.6 TYPICAL CAPACITANCE



RATING AND CHARACTERISTIC CURVES (CZRERT52C2 Thru CZRERT52C39)

Fig.7 ZENER VOLTAGE VERSUS ZENER CURRENT

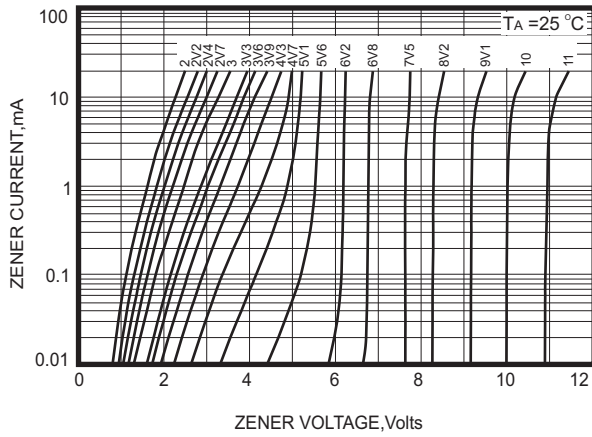

Fig.8 ZENER VOLTAGE VERSUS ZENER CURRENT

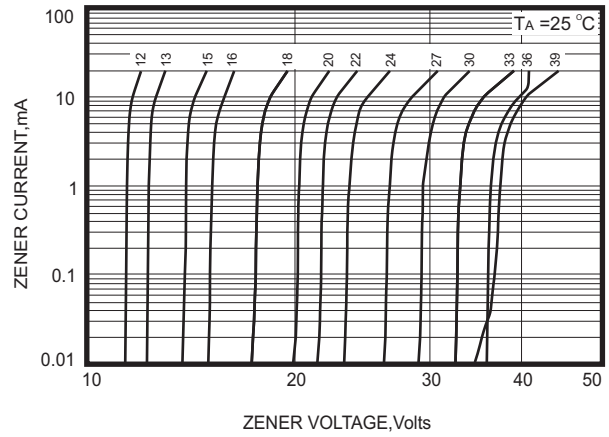
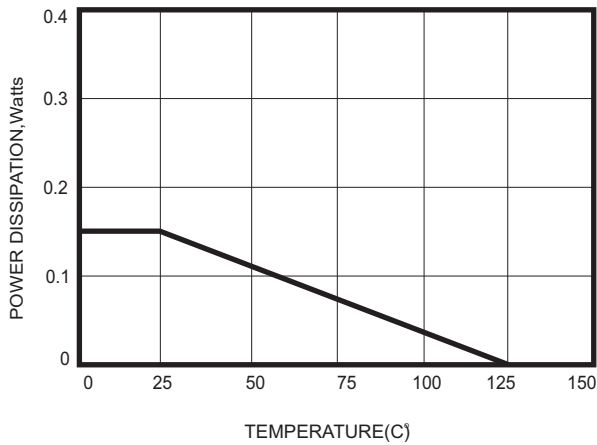
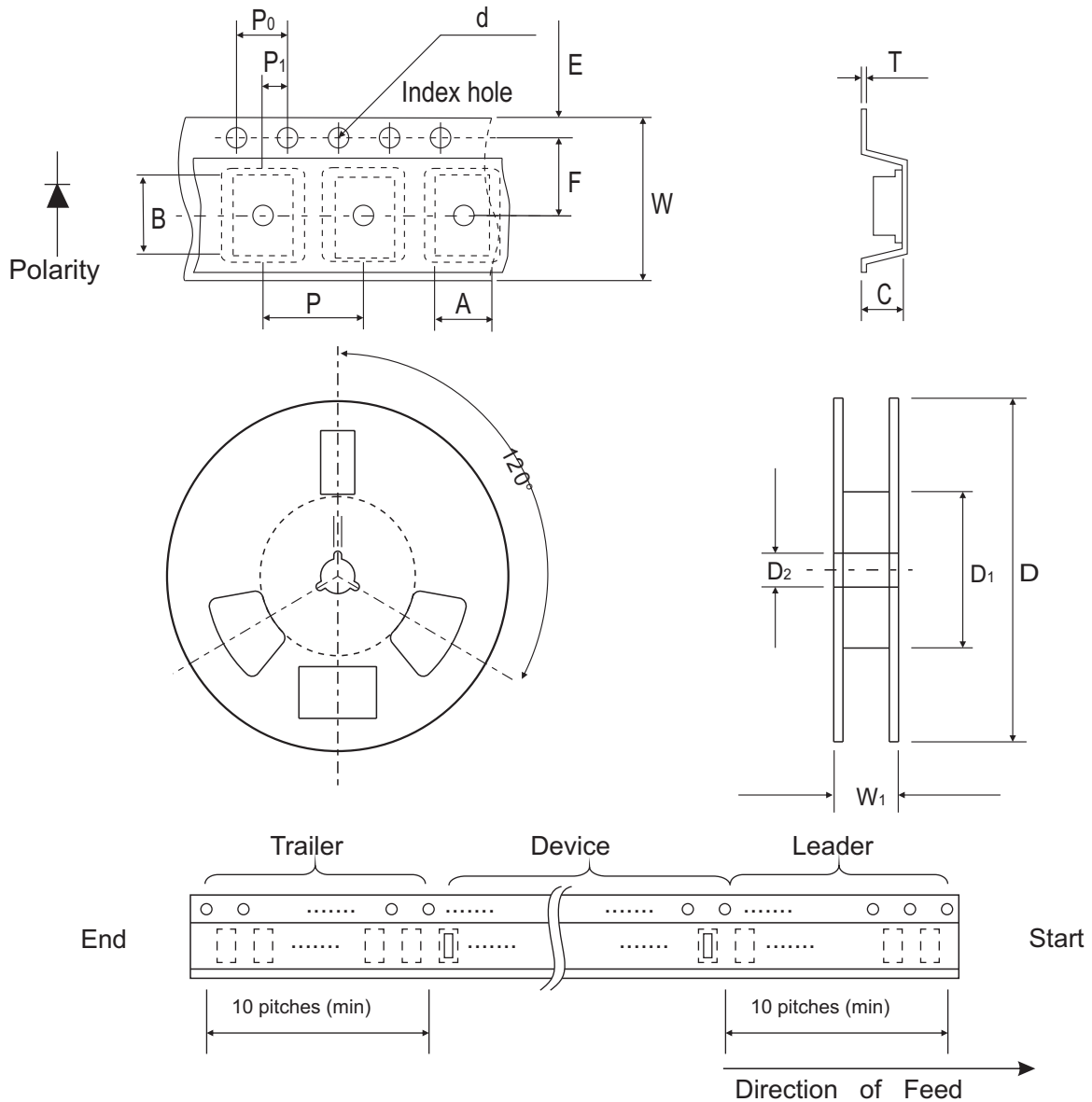

Fig.9 STEADY STATE POWER DERATING



Reel Taping Specification



0503 (SOD-723F)	SYMBOL	A	B	C	d	D	D ₁	D ₂
	(mm)	0.90 ± 0.10	1.46 ± 0.10	0.60 ± 0.10	1.55 ± 0.10	178 ± 1	60.0 MIN.	13.0 ± 0.20
	(inch)	0.035 ± 0.004	0.057 ± 0.004	0.024 ± 0.004	0.061 ± 0.004	7.008 ± 0.04	2.362 MIN.	0.512 ± 0.008

0503 (SOD-723F)	SYMBOL	E	F	P	P ₀	P ₁	T	W	W ₁
	(mm)	1.75 ± 0.10	3.50 ± 0.05	4.00 ± 0.10	4.00 ± 0.10	2.00 ± 0.10	0.22 ± 0.05	8.00 ± 0.20	13.5 MAX.
	(inch)	0.069 ± 0.004	0.138 ± 0.002	0.157 ± 0.004	0.157 ± 0.004	0.079 ± 0.004	0.009 ± 0.002	0.315 ± 0.008	0.531 MAX.

Suggested PAD Layout

SIZE	0503/SOD-723F	
	(mm)	(inch)
A	0.85	0.033
B	0.55	0.022
C	0.85	0.033
D	1.40	0.055
E	0.30	0.012

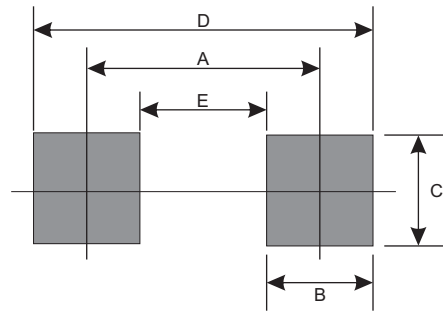

Standard Package

Case Type	Qty per Reel	Reel Size
	(Pcs)	(inch)
0503/SOD-723F	4000	7