

CDBB120SLR-HF Thru. CDBB160SLR-HF

Reverse Voltage: 20 to 60 Volts

Forward Current: 1.0 Amp

RoHS Device

Halogen Free

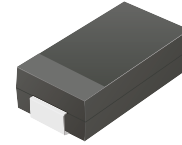

Features

- Low Profile surface mount applications in order to optimize board space.
- Low power loss, high efficiency.
- High current capability, low forward voltage drop.
- High surge capability.
- Guardring for overvoltage protection.
- Ultra high-speed switching.
- Silicon epitaxial planar chip, metal silicon junction.

Mechanical data

- Epoxy: UL94-V0 rate flame retardant.
- Case: Molded plastic, DO-214AA / SMB
- Terminals: solderable per MIL-STD-750, method 2026.
- Polarity: Indicated by cathode band.
- Weight: 0.091 grams

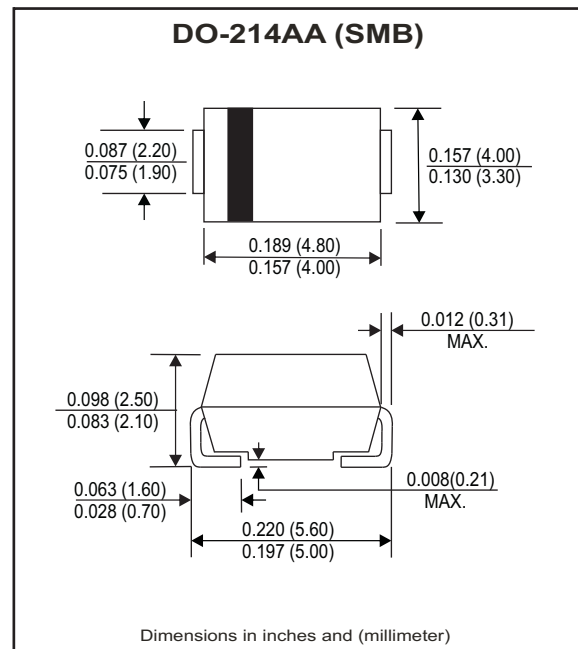

Maximum Ratings and Electrical Characteristics

Ratings at $T_a=25^\circ\text{C}$ unless otherwise noted.
Single phase, half wave, 60Hz, resistive or inductive loaded.
For capacitive load, derate current by 20% .

Parameter	Symbol	CDBB120SLR-HF	CDBB140SLR-HF	CDBB160SLR-HF	Units
Max. Repetitive peak reverse voltage	V_{RRM}	20	40	60	V
Max. DC blocking voltage	V_{DC}	20	40	60	V
Max. RMS voltage	V_{RMS}	14	28	42	V
Max. instantaneous forward voltage @ 1.0A, $T_A=25^\circ\text{C}$	V_F	0.35	0.40	0.50	V
Operating Temperature	T_J	-50 to +150			$^\circ\text{C}$

Parameter	Conditions	Symbol	MIN.	TYP.	MAX.	Units
Forward rectified current	see Fig.1	I_o			1.0	A
Forward surge current	8.3ms single half sine-wave superimposed on rate load (JEDEC method)	I_{FSM}			30	A
Reverse Current	$V_R = V_{RRM}$ $T_A=25^\circ\text{C}$	I_R			0.5	mA
	$V_R = V_{RRM}$ $T_A=100^\circ\text{C}$	I_R			20	mA
Thermal Resistance	Junction to ambient	$R_{\theta JA}$		88		$^\circ\text{C}/\text{W}$
Diode Junction capacitance	f=1MHz and applied 4V DC reverse Voltage	C_J		120		pF
Storage temperature		T_{STG}	-50		+150	$^\circ\text{C}$

RATING AND CHARACTERISTIC CURVES (CDBB120SLR-HF Thru. CDBB160SLR-HF)

Fig.1- Typical Forward Current Derating Curve

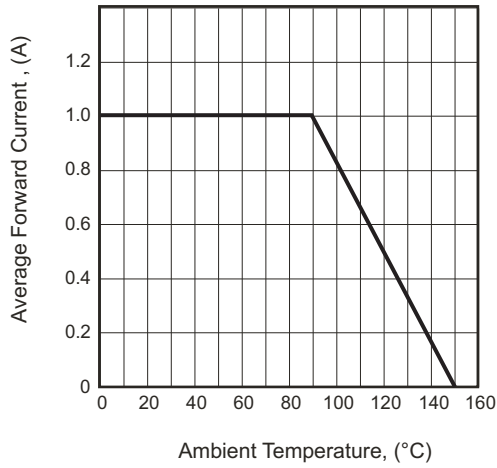

Fig.2- Typical Forward Characteristics

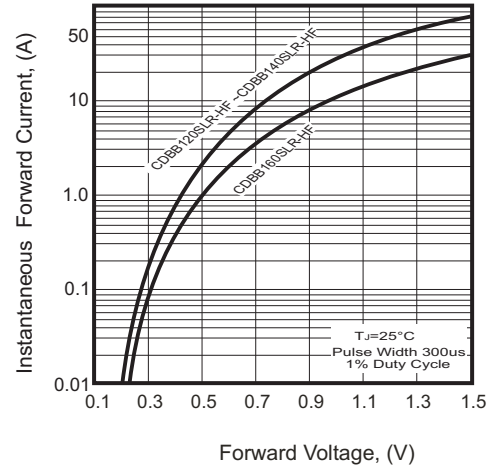

Fig.3- Maximum Non-repetitive Forward Surge Current

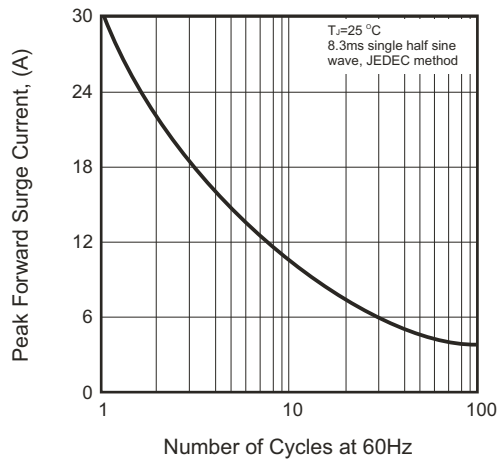

Fig.4- Typical Junction Capacitance

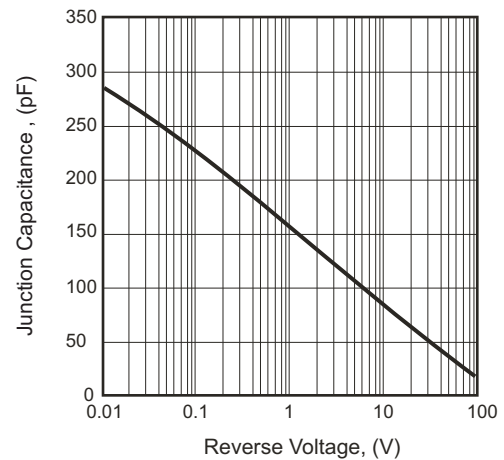
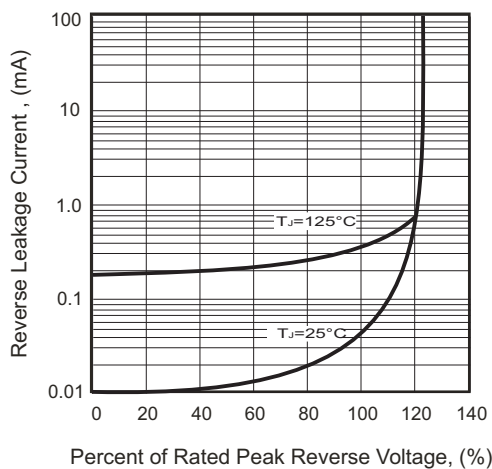
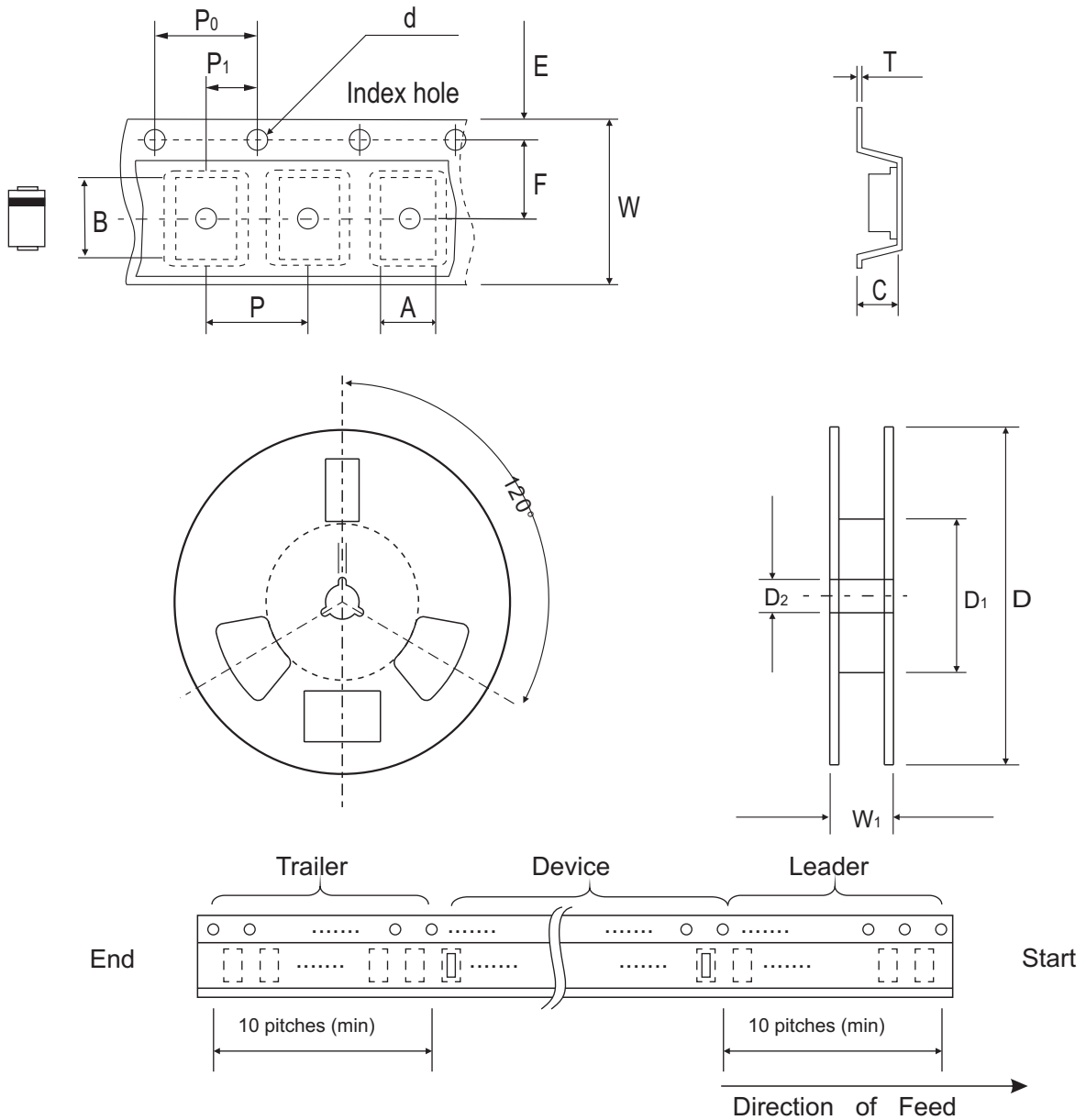

Fig.5- Typical Reverse Characteristics



Reel Taping Specification



DO-214AA (SMB)	SYMBOL	A	B	C	d	D	D1	D2
	(mm)	4.00 ± 0.10	5.90 ± 0.10	3.00 ± 0.10	1.50 ± 0.10	330 ± 2.00	50.0 MIN.	13.50 ± 0.50
	(inch)	0.157 ± 0.004	0.232 ± 0.004	0.118 ± 0.004	0.059 ± 0.004	12.99 ± 0.079	1.969 MIN.	0.531 ± 0.020

DO-214AA (SMB)	SYMBOL	E	F	P	P0	P1	T	W	W1
	(mm)	1.75 ± 0.10	5.50 ± 0.10	8.00 ± 0.10	4.00 ± 0.10	2.00 ± 0.10	0.60 ± 0.10	12.0 ± 0.30	18.4 ± 1.00
	(inch)	0.069 ± 0.004	0.217 ± 0.004	0.315 ± 0.004	0.157 ± 0.004	0.079 ± 0.004	0.236 ± 0.004	0.472 ± 0.012	0.724 ± 0.040

Marking Code

Part Number	Marking Code
CDBB120SLR-HF	KS12
CDBB140SLR-HF	KS14
CDBB160SLR-HF	KS16



xxxx = Product type marking code

Suggested PAD Layout

SIZE	DO-214AA (SMB)	
	(mm)	(inch)
A	4.30	0.169
B	2.50	0.098
C	2.30	0.091
D	6.10	0.240
E	1.80	0.071

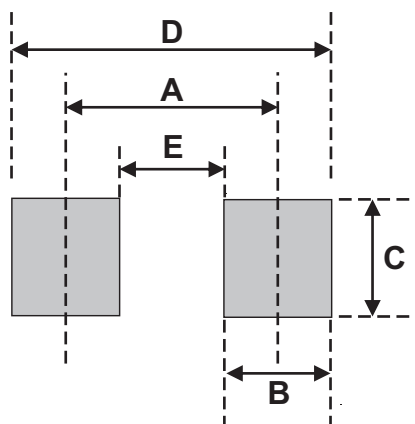

Standard Packaging

Case Type	REEL PACK	
	REEL (pcs)	Reel Size (inch)
DO-214AA (SMB)	3,000	13