

SHIELDED POWER INDUCTOR



12.0 x 12.0 x 8.0 mm

ASPI-1207S-xxx



RoHS
Compliant

FEATURES:

- High saturation
- Magnetic shielding
- Very small footprint
- Flat-top for pick and place
- Low resistance to keep power loss minimum

APPLICATIONS:

- Palm-top and laptop
- LCD TV
- Power line DC to DC converters used in hard drive, notebook computer

ELECTRICAL SPECIFICATIONS:

PARAMETERS

ABRACON P/N	ASPI-1207S-xxx
Operating Temperature	-40°C to +85°C
Storage Temperature	Under +25°C, Humidity <75% R.H.

Part Number ASPI-1207S-	L (μ H)	Tolerance %	R _{DC} (Ω) Max	I _{DC} (A)Max
1R0	1.0	M	0.006	14.00
2R4	2.4	M	0.010	10.30
3R5	3.5	M	0.012	9.30
4R6	4.6	M	0.014	9.10
5R8	5.8	M	0.016	8.60
7R4	7.4	M	0.018	7.40
100	10	M	0.019	6.70
120	12	M	0.021	6.45
150	15	M	0.026	5.65
180	18	M	0.028	5.10
220	22	M	0.036	4.70
270	27	M	0.041	4.20
330	33	M	0.053	3.90
390	39	M	0.060	3.50
470	47	M	0.078	3.25
560	56	M	0.090	2.90
680	68	M	0.120	2.60
820	82	M	0.119	2.40
101	100	M	0.151	2.10
121	120	M	0.169	1.90
151	150	M	0.227	1.80
181	180	M	0.299	1.55
221	220	M	0.338	1.45
271	270	M	0.419	1.30
331	330	M	0.471	1.20

Part Number ASPI-1207S-	L (μ H)	Tolerance %	R _{DC} (Ω) Max	I _{DC} (A)Max
391	390	M	0.572	1.10
471	470	M	0.741	1.00
561	560	M	0.852	0.95
681	680	M	1.130	0.85
821	820	M	1.240	0.75
102	1000	M	1.500	0.70

Note: Tolerance M=±20%
Inductance tested at 100KHz, 0.1VRMS

OPTIONS & PART IDENTIFICATION:

[Left blank if standard]

ASPI - 1207S - □□□ M - □

Inductance Code
Refer to the Table

Packaging
T Tape & Reel

ABRACON IS
ISO 9001 / QS 9000
CERTIFIED

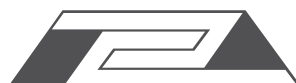

ABRACON
CORPORATION

Visit www.abracon.com for Terms & Conditions of Sale **Revised: 08.05.09**

30332 Esperanza, Rancho Santa Margarita, California 92688

tel 949-546-8000 | fax 949-546-8001 | www.abracon.com

SHIELDED POWER INDUCTOR



12.0 x 12.0 x 8.0 mm

ASPI-1207S-xxx



OUTLINE DRAWING:

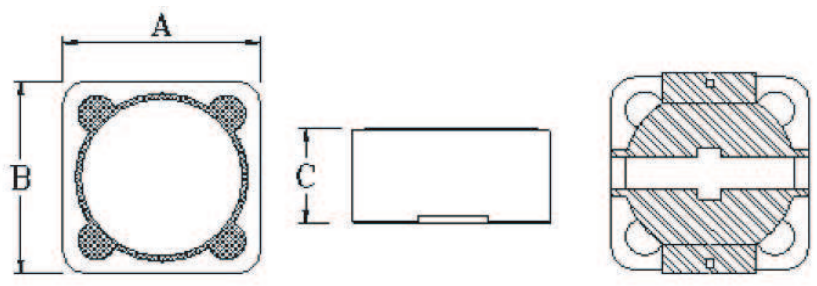

Recommended Land Pattern

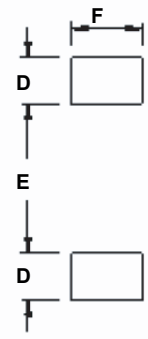

Part#	A	B	C
ASPI-1207S-xxx	0.472±0.012 (12.0±0.3)	0.472±0.012 (12.0±0.3)	0.315 max. (8.0 max.)

Part#	D	E	F
ASPI-1207S-xxx	0.110 ref. (2.8 ref.)	0.276 ref. (7.0 ref.)	0.213 ref. (5.4 ref.)

TAPE & REEL: T = Tape and reel 500pcs/reel

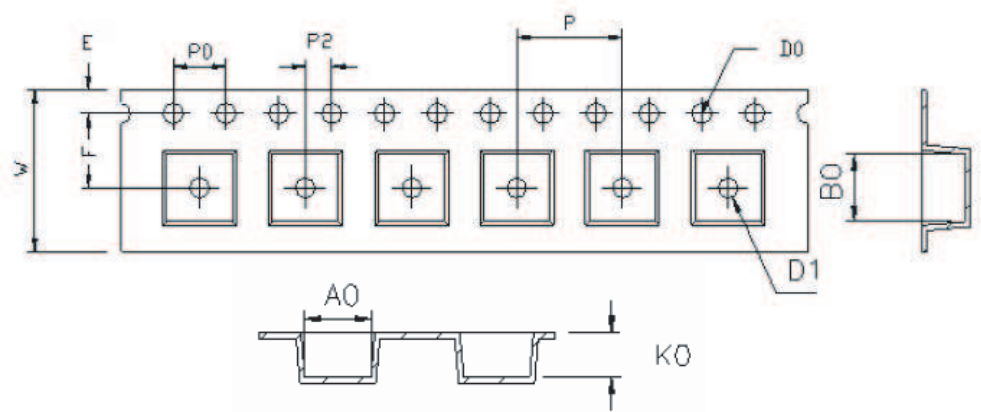

Part#	A0	B0	K0	P	P0	P2
ASPI-1207S-xxx	12.6±0.1	12.6±0.1	8.2±0.1	16.0±0.1	4.0±0.1	2.0±0.1

Part#	W	F	E	D0	D1
ASPI-1207S-xxx	24±0.3	11.5±0.1	1.75±0.1	1.5 min.	1.5 min.

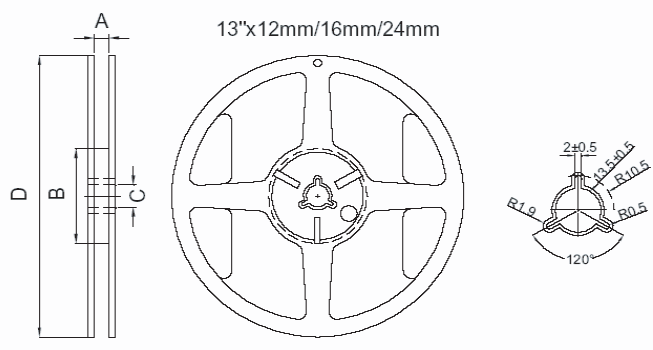

series	A	B	C	D
ASPI-1207S-xxx	24.5±0.2	100±0.05	13.2±0.3	330±1.0

Dimension : mm

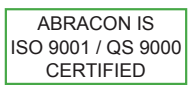

Visit www.abracon.com for Terms & Conditions of Sale **Revised: 08.05.09**
 30332 Esperanza, Rancho Santa Margarita, California 92688
 tel 949-546-8000 | fax 949-546-8001 | www.abracon.com

SHIELDED POWER INDUCTOR

ASPI-1207S-xxx



RoHS
Compliant



12.0 x 12.0 x 8.0 mm

REFLOW PROFILE:

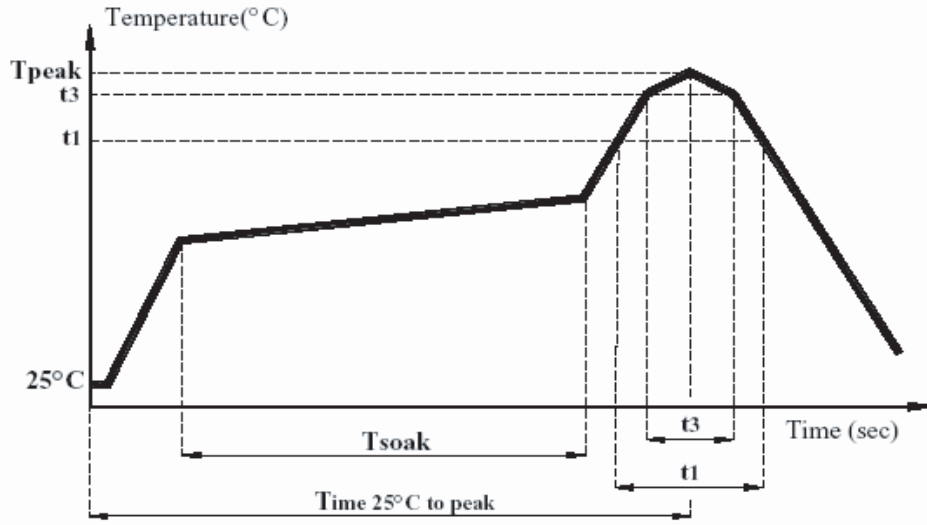

Dimensions: mm

NOTE: Abracon manufactured products are intended for general commercial and industrial use. For applications requiring high reliability and/or presenting extreme operating environment, written consent & authorization from Abracon is required.

ABRACON IS
ISO 9001 / QS 9000
CERTIFIED



Visit www.abracon.com for Terms & Conditions of Sale **Revised: 08.05.09**
30332 Esperanza, Rancho Santa Margarita, California 92688
tel 949-546-8000 | fax 949-546-8001 | www.abracon.com