

FEATURES

- Low Reverse Recovery Charge
- High Switching Speed
- Low Forward Volt Drop
- Isolated AISiC Base with AlN Substrates
- Dual Diodes can be paralleled for 1200A Rating
- Lead Free Construction

APPLICATIONS

- Chopper Diodes
- Boost and Buck Circuits
- Free-wheel Circuits
- Multi-level Switch Inverters

The DFM600FXM18-A000 is a dual 1800V, fast recovery diode (FRD) module. Designed for low power loss, the module is suitable for a variety of high voltage applications in motor drives and power conversion.

Fast switching times and low reverse recovery losses allow high frequency operation, making the device suitable for the latest drive designs employing PWM and high frequency switching.

The module incorporates an electrically isolated base plate and low inductance construction enabling circuit designers to optimise circuit layouts and utilise grounded heat sinks for safety.

ORDERING INFORMATION

Order As:

DFM600FXM18-A000

Note: When ordering, please use the complete part number

KEY PARAMETERS

V_{RRM}		1800V
V_F	(typ)	2.0V
I_F	(max)	600A
I_{FM}	(max)	1200A

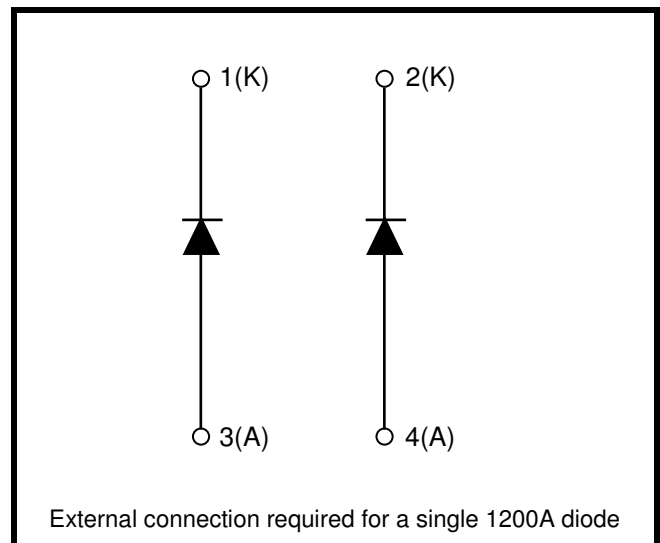

Fig. 1 Circuit configuration

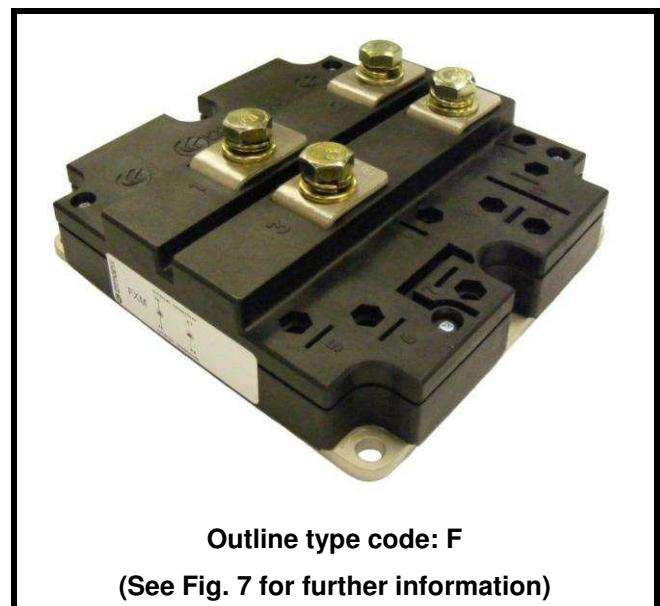

Fig. 2 Package

ABSOLUTE MAXIMUM RATINGS

Stresses above those listed under 'Absolute Maximum Ratings' may cause permanent damage to the device. In extreme conditions, as with all semiconductors, this may include potentially hazardous rupture of the package. Appropriate safety precautions should always be followed. Exposure to Absolute Maximum Ratings may affect device reliability.

$T_{\text{case}} = 25\text{ °C}$ unless stated otherwise

Symbol	Parameter	Test Conditions	Max.	Units
V_{RRM}	Repetitive peak reverse voltage	$T_j = 125\text{ °C}$	1800	V
I_F	Forward current (per arm)	DC, $T_{\text{case}} = 75\text{ °C}$, $T_j = 125\text{ °C}$	600	A
I_{FM}	Max. forward current	$T_{\text{case}} = 110\text{ °C}$, $t_p = 1\text{ ms}$	1200	A
I^2t	I^2t value fuse current rating	$V_R = 0$, $t_p = 10\text{ ms}$, $T_j = 125\text{ °C}$	120	kA^2s
P_{max}	Max. transistor power dissipation	$T_{\text{case}} = 25\text{ °C}$, $T_j = 125\text{ °C}$	2500	W
V_{isol}	Isolation voltage – per module	Commoned terminals to base plate. AC RMS, 1 min, 50Hz	4000	V
Q_{PD}	Partial discharge – per module	IEC1287, $V_1 = 1900\text{ V}$, $V_2 = 1400\text{ V}$, 50Hz RMS	10	pC

THERMAL AND MECHANICAL RATINGS

Internal insulation material:	AlN
Baseplate material:	AlSiC
Creepage distance:	20mm
Clearance:	10mm
CTI (Comparative Tracking Index):	350

Symbol	Parameter	Test Conditions	Min	Typ.	Max	Units
$R_{\text{th(j-c)}}$	Thermal resistance (per arm)	Continuous dissipation – junction to case	-	-	40	°C/kW
$R_{\text{th(c-h)}}$	Thermal resistance – case to heatsink (per module)	Mounting torque 5Nm (with mounting grease)	-	-	8	°C/kW
T_j	Junction temperature		-	-	125	°C
T_{stg}	Storage temperature range		-40	-	125	°C
	Screw Torque	Mounting – M6	-	-	5	Nm
		Electrical connections – M8	-	-	10	Nm

STATIC ELECTRICAL CHARACTERISTICS – PER ARM
T_{case} = 25 °C unless stated otherwise.

Symbol	Parameter	Test Conditions	Min	Typ	Max	Units
I _{RM}	Peak reverse current	V _R = 1800V, T _j = 125 °C			10	mA
V _F	Forward voltage	I _F = 600A		2.0	2.3	V
		I _F = 600A, T _j = 125 °C		2.0	2.3	V
L _M	Inductance			20		nH

STATIC ELECTRICAL CHARACTERISTICS
T_{case} = 25 °C unless stated otherwise.

Symbol	Parameter	Test Conditions	Min	Typ	Max	Units
L _M	Module inductance (externally connected in parallel)			15		nH

DYNAMIC ELECTRICAL CHARACTERISTICS – PER ARM
T_{case} = 25 °C unless stated otherwise

Symbol	Parameter	Test Conditions	Min	Typ.	Max	Units
Q _{rr}	Reverse recovery charge	I _F = 600A V _R = 900V di _F /dt = 4000A/μs		160		μC
I _{rr}	Peak reverse recovery current			440		A
E _{rec}	Reverse recovery energy			120		mJ

T_{case} = 125 °C unless stated otherwise

Symbol	Parameter	Test Conditions	Min	Typ.	Max	Units
Q _{rr}	Reverse recovery charge	I _F = 600A V _R = 900V di _F /dt = 4000A/μs		270		μC
I _{rr}	Peak reverse recovery current			510		A
E _{rec}	Reverse recovery energy			180		mJ

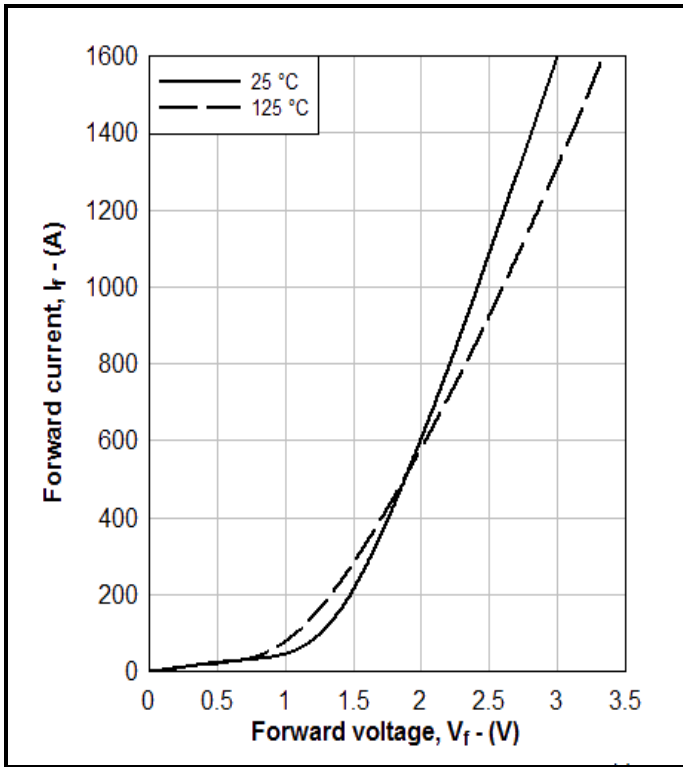

Fig. 3 Diode typical forward characteristics

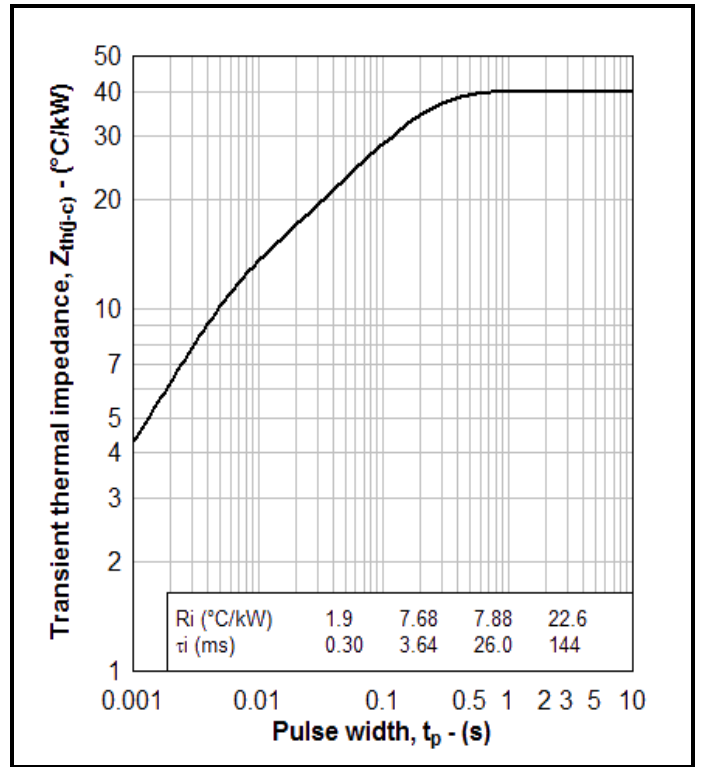

Fig. 4 Transient thermal impedance

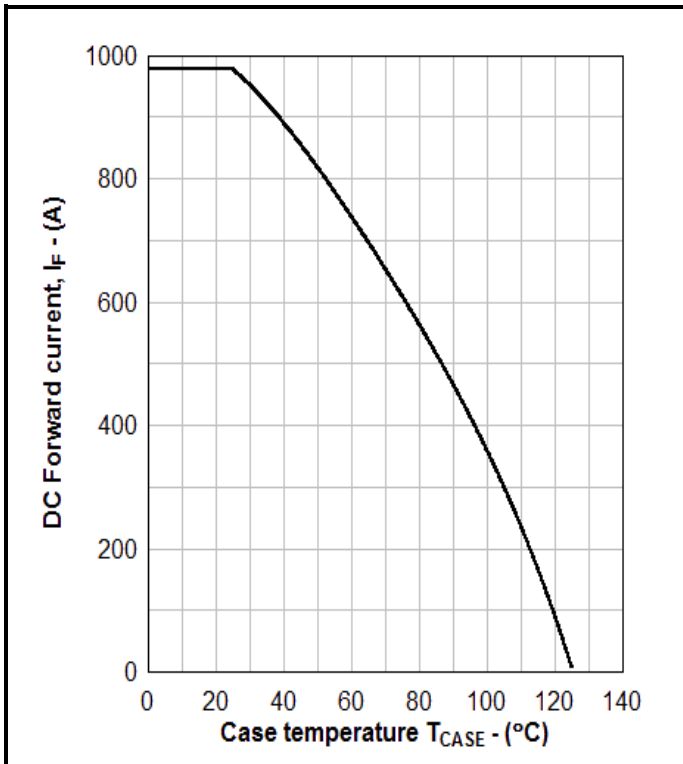

Fig. 5 DC Current rating vs case temperature

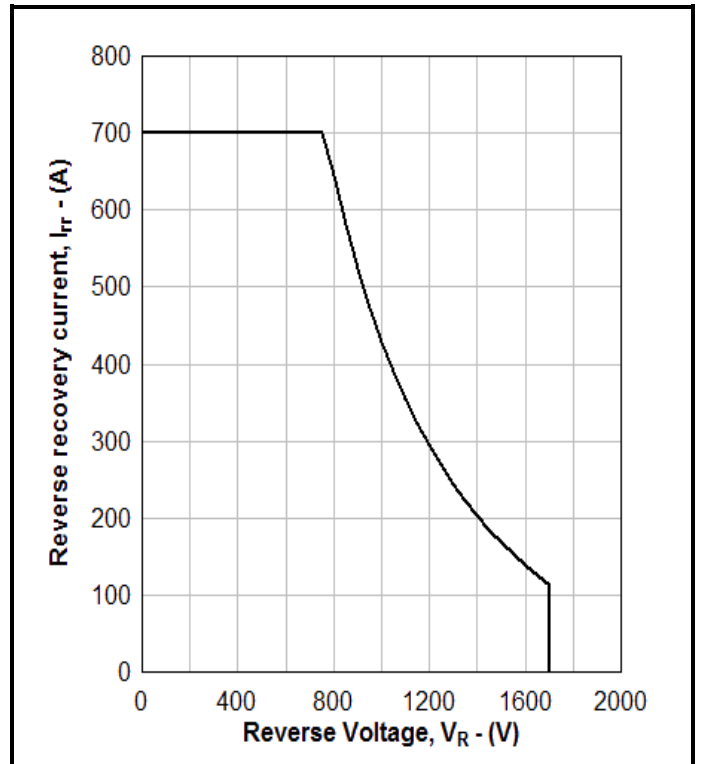
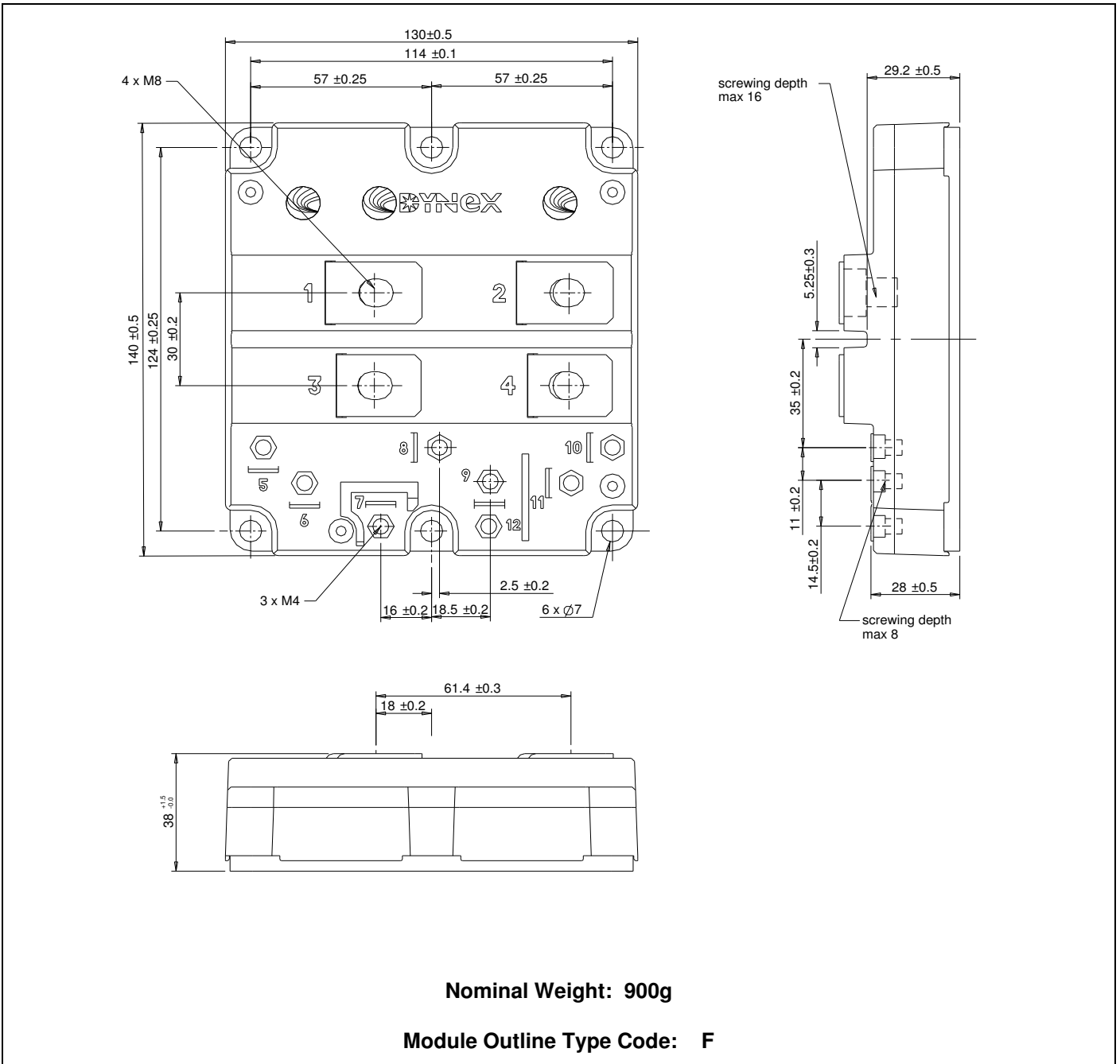

Fig. 6 RBSOA

PACKAGE DETAILS

For further package information, please visit our website or contact Customer Services.
 All dimensions in mm, unless stated otherwise.
DO NOT SCALE.



Nominal Weight: 900g

Module Outline Type Code: F

Fig. 7 Module outline drawing

HEADQUARTERS OPERATIONS**DYNEX SEMICONDUCTOR LTD**

Doddington Road, Lincoln
Lincolnshire, LN6 3LF, United Kingdom

Fax: +44(0)1522 500550

Tel: +44(0)1522 500500

CUSTOMER SERVICE**DYNEX SEMICONDUCTOR LTD**

Doddington Road, Lincoln
Lincolnshire, LN6 3LF, United Kingdom

Fax: +44(0)1522 500020

Tel: +44(0)1522 502901 / 502753

email: power_solutions@dynexsemi.com

© Dynex Semiconductor TECHNICAL DOCUMENTATION – NOT FOR RESALE. PRODUCED IN UNITED KINGDOM.

Datasheet Annotations: Dynex Semiconductor annotate datasheets in the top right hand corner of the front page, to indicate product status.

The annotations are as follows:-

Target Information:	This is the most tentative form of information and represents a very preliminary specification. No actual work on the product has been started.
Preliminary Information:	The product is in design and development. The datasheet represents the product as it is understood but may change.
Advance Information:	The product design is complete and final characterisation for volume production is well in hand.
No Annotation:	The product parameters are fixed and the product is available to datasheet specification.

This publication is issued to provide information only which (unless agreed by the company in writing) may not be used, applied or reproduced for any purpose nor form part of any order or contract nor to be regarded as a representation relating to the products or services concerned. No warranty or guarantee expressed or implied is made regarding the capability, performance or suitability of any product or service. The Company reserves the right to alter without prior notice the specification, design or price of any product or service. Information concerning possible methods of use is provided as a guide only and does not constitute any guarantee that such methods of use will be satisfactory in a specific piece of equipment. It is the users responsibility to fully determine the performance and suitability of any equipment using such information and to ensure that any publication or data used is up to date and has not been superseded. These products are not suitable for use in any medical products whose failure to perform may result in significant injury or death to the user. All products and materials are sold and services provided subject to the Company's conditions of sale, which are available on request.

All brand names and product names used in this publication are trademarks, registered trademarks or trade names of their respective owners.