

FEATURES

- Double Side Cooling
- High Surge Capability

APPLICATIONS

- High Power Drives
- High Voltage Power Supplies
- Static Switches

VOLTAGE RATINGS

Part and Ordering Number	Repetitive Peak Voltages V_{DRM} and V_{RRM} V	Conditions
DCR2880B65*	6500	$T_{vj} = -40^{\circ}\text{C}$ to 125°C , $I_{DRM} = I_{RRM} = 300\text{mA}$, $V_{DRM}, V_{RRM} t_p = 10\text{ms}$, $V_{DSM} \& V_{RSM} =$ $V_{DRM} \& V_{RRM} + 100\text{V}$ respectively
DCR2880B60	6000	
DCR2880B55	5500	
DCR2880B50	5000	

Lower voltage grades available.
 *6200V @ -40°C , 6500V@ 0°C

ORDERING INFORMATION

When ordering, select the required part number shown in the Voltage Ratings selection table.

For example:

DCR2880B65

Note: Please use the complete part number when ordering and quote this number in any future correspondence relating to your order.

KEY PARAMETERS

V_{DRM}	6500V
$I_{T(AV)}$	2845A
I_{TSM}	38500A
dV/dt^*	1500V/μs
dI/dt	300A/μs

* Higher dV/dt selections available

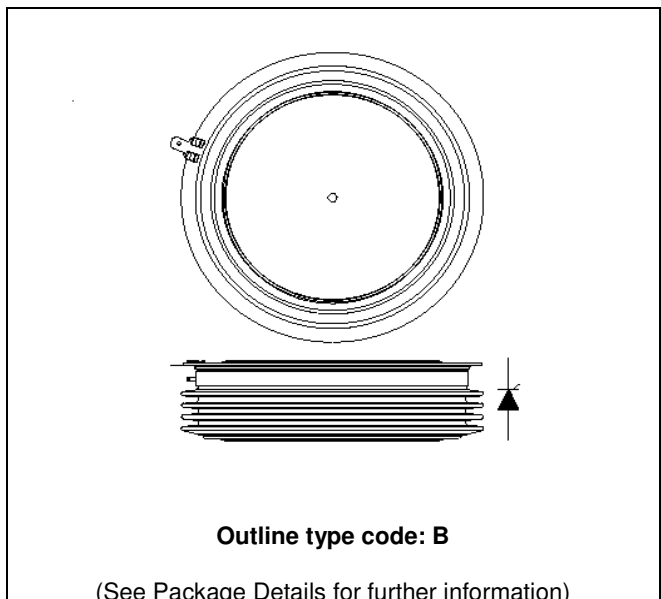

Fig. 1 Package outline

CURRENT RATINGS

$T_{case} = 60^{\circ}\text{C}$ unless stated otherwise

Symbol	Parameter	Test Conditions	Max.	Units
Double Side Cooled				
$I_{T(AV)}$	Mean on-state current	Half wave resistive load	2845	A
$I_{T(RMS)}$	RMS value	-	4469	A
I_T	Continuous (direct) on-state current	-	4130	A

SURGE RATINGS

Symbol	Parameter	Test Conditions	Max.	Units
I_{TSM}	Surge (non-repetitive) on-state current	10ms half sine, $T_{case} = 125^{\circ}\text{C}$	38.85	kA
I^2t	I^2t for fusing	$V_R = 0$	7.55	MA^2s

THERMAL AND MECHANICAL RATINGS

Symbol	Parameter	Test Conditions	Min.	Max.	Units	
$R_{th(j-c)}$	Thermal resistance – junction to case	Double side cooled	DC	-	0.007	$^{\circ}\text{C/W}$
		Single side cooled	Anode DC	-	0.0116	$^{\circ}\text{C/W}$
			Cathode DC	-	0.0181	$^{\circ}\text{C/W}$
$R_{th(c-h)}$	Thermal resistance – case to heatsink	Clamping force 76.0kN (with mounting compound)	Double side	-	0.0014	$^{\circ}\text{C/W}$
			Single side	-	0.0028	$^{\circ}\text{C/W}$
T_{vj}	Virtual junction temperature	Blocking V_{DRM} / V_{RRM}	-	125	$^{\circ}\text{C}$	
T_{stg}	Storage temperature range		-55	125	$^{\circ}\text{C}$	
F_m	Clamping force		68.0	84.0	kN	

DYNAMIC CHARACTERISTICS

Symbol	Parameter	Test Conditions	Min.	Max.	Units	
I_{RRM}/I_{DRM}	Peak reverse and off-state current	At V_{RRM}/V_{DRM} , $T_{case} = 125^{\circ}C$	-	300	mA	
dV/dt	Max. linear rate of rise of off-state voltage	To 67% V_{DRM} , $T_j = 125^{\circ}C$, gate open	-	1500	V/ μs	
dl/dt	Rate of rise of on-state current	From 67% V_{DRM} to $2x I_{T(AV)}$	Repetitive 50Hz	-	150	A/ μs
		Gate source 30V, 10 Ω , $t_r < 0.5\mu s$, $T_j = 125^{\circ}C$	Non-repetitive	-	300	A/ μs
$V_{T(TO)}$	Threshold voltage – Low level	500 to 2400A at $T_{case} = 125^{\circ}C$	-	0.94	V	
	Threshold voltage – High level	2400 to 7200A at $T_{case} = 125^{\circ}C$	-	1.13	V	
r_T	On-state slope resistance – Low level	500A to 2400A at $T_{case} = 125^{\circ}C$	-	0.343	m Ω	
	On-state slope resistance – High level	2400A to 7200A at $T_{case} = 125^{\circ}C$	-	0.264	m Ω	
t_{gd}	Delay time	$V_D = 67\% V_{DRM}$, gate source 30V, 10 Ω $t_r = 0.5\mu s$, $T_j = 25^{\circ}C$	-	3	μs	
t_q	Turn-off time	$T_j = 125^{\circ}C$, $V_R = 200V$, $dl/dt = 1A/\mu s$, $dV_{DR}/dt = 20V/\mu s$ linear	-	1200	μs	
Q_S	Stored charge	$I_T = 2000A$, $T_j = 125^{\circ}C$, $dl/dt = 1A/\mu s$,	2800	6400	μC	
I_L	Latching current	$T_j = 25^{\circ}C$, $V_D = 5V$	-	3	A	
I_H	Holding current	$T_j = 25^{\circ}C$, $R_{G-K} = \infty$, $I_{TM} = 500A$, $I_T = 5A$	-	300	mA	

GATE TRIGGER CHARACTERISTICS AND RATINGS

Symbol	Parameter	Test Conditions	Max.	Units
V _{GT}	Gate trigger voltage	V _{DRM} = 5V, T _{case} = 25 °C	1.5	V
V _{GD}	Gate non-trigger voltage	At 50% V _{DRM} , T _{case} = 125 °C	0.4	V
I _{GT}	Gate trigger current	V _{DRM} = 5V, T _{case} = 25 °C	400	mA
I _{GD}	Gate non-trigger current	At 50% V _{DRM} , T _{case} = 125 °C	10	mA

CURVES

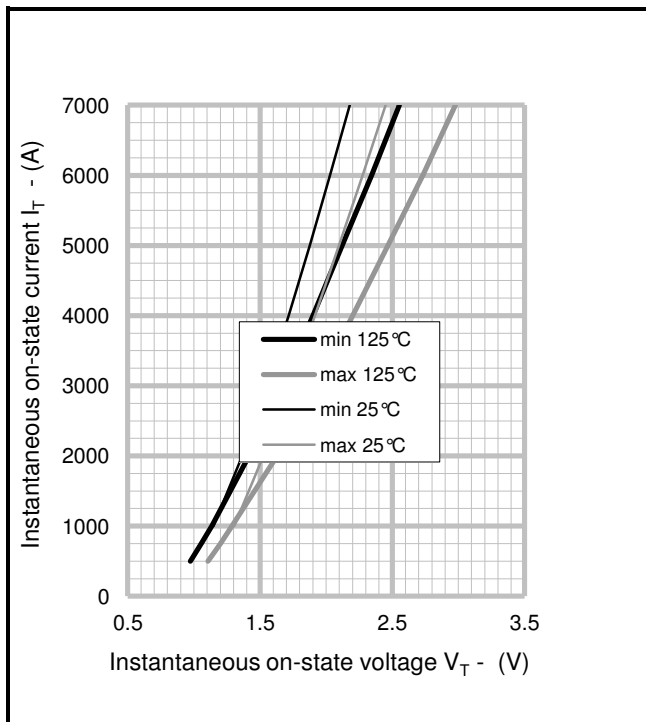

Fig.2 Maximum & minimum on-state characteristics

V_{TM} EQUATION

$$V_{TM} = A + B \ln(I_T) + C \cdot I_T + D \cdot \sqrt{I_T}$$

Where A = 0.914146
 B = -0.03808
 C = 0.00016
 D = 0.015311

these values are valid for T_j = 125 °C for I_T 500A to 7200A

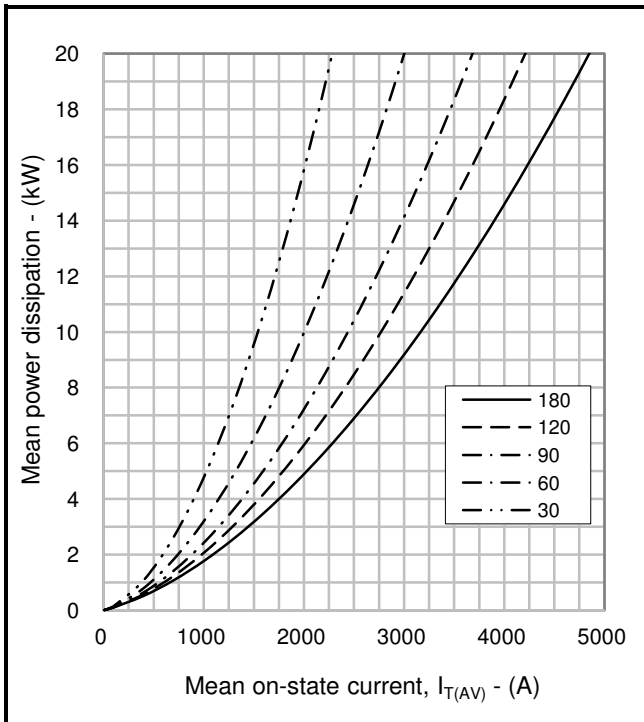

Fig.3 On-state power dissipation – sine wave

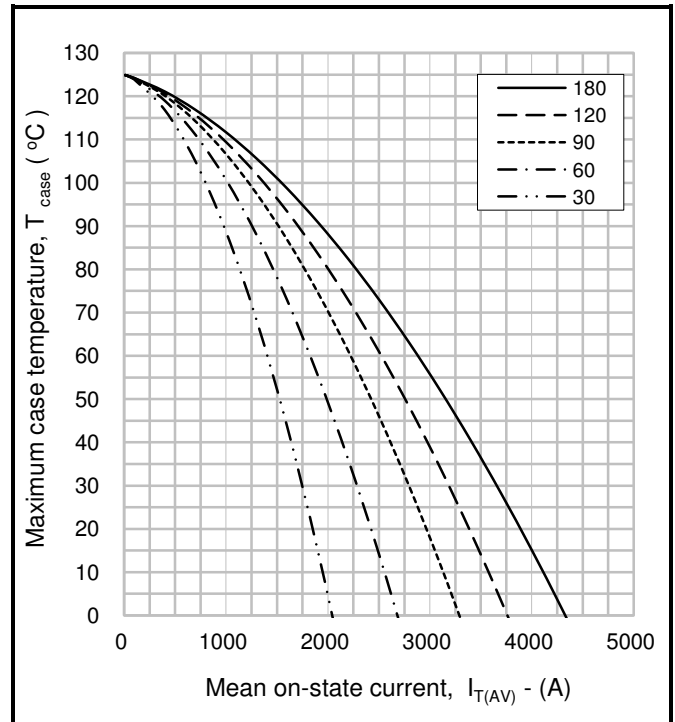

Fig.4 Maximum permissible case temperature, double side cooled – sine wave

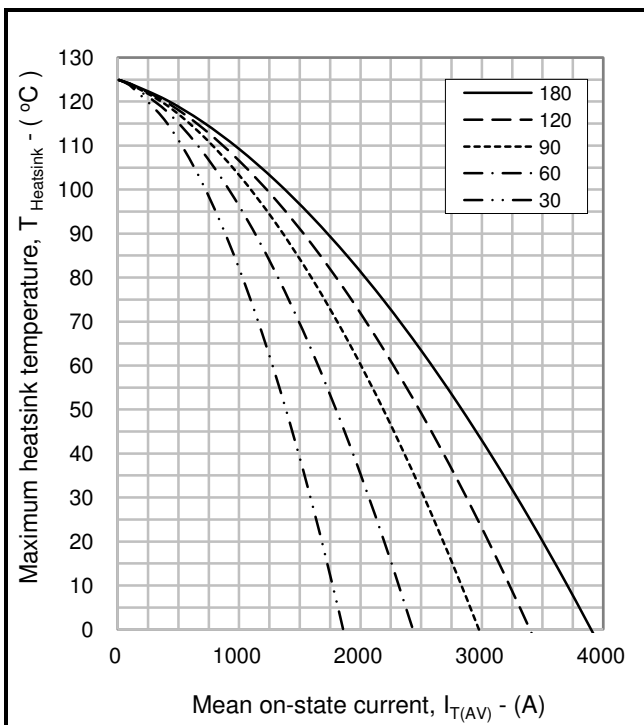

Fig.5 Maximum permissible heatsink temperature, double side cooled – sine wave

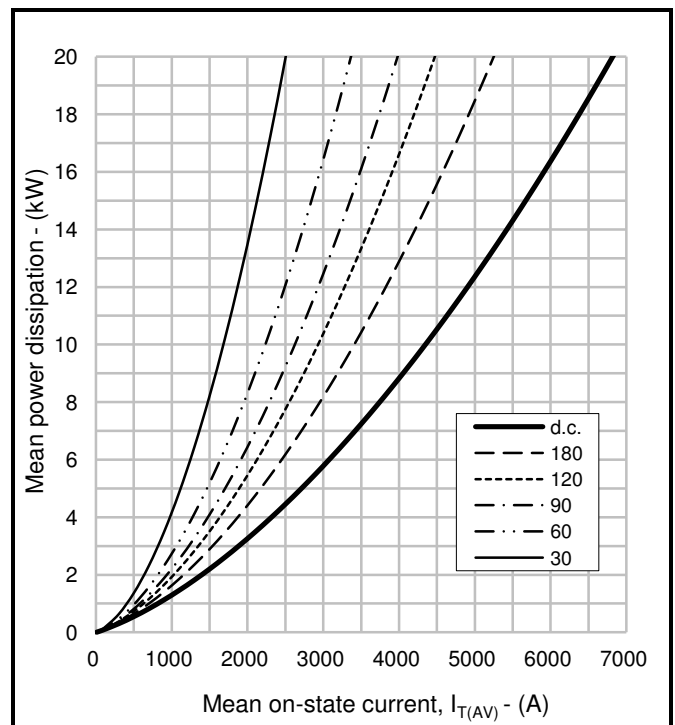

Fig.6 On-state power dissipation – rectangular wave

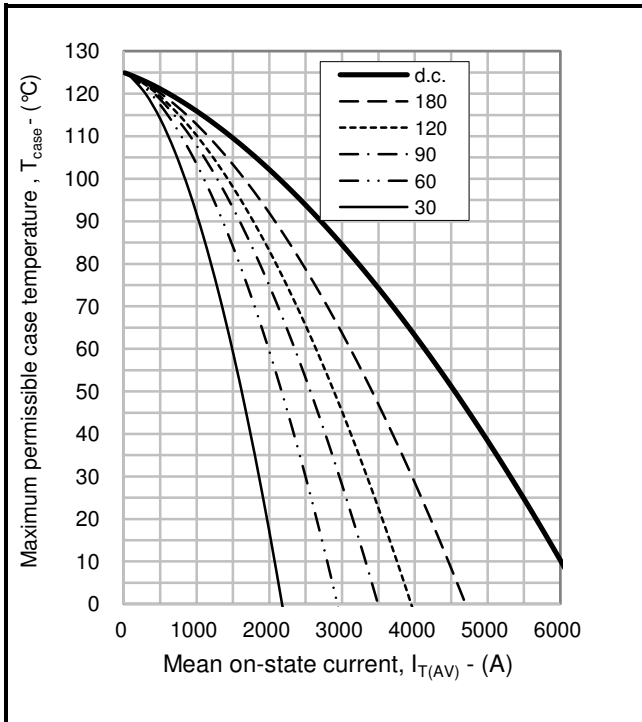

Fig.7 Maximum permissible case temperature, double side cooled – rectangular wave

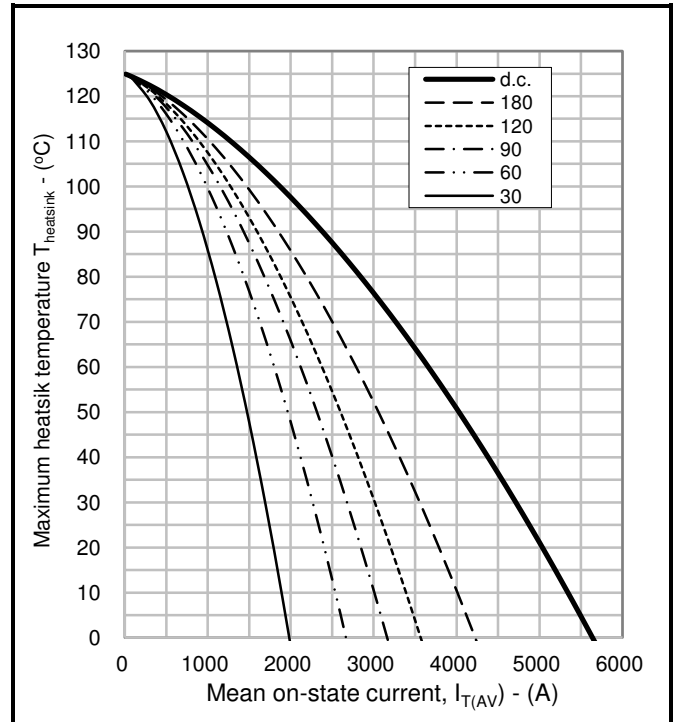

Fig.8 Maximum permissible heatsink temperature, double side cooled – rectangular wave

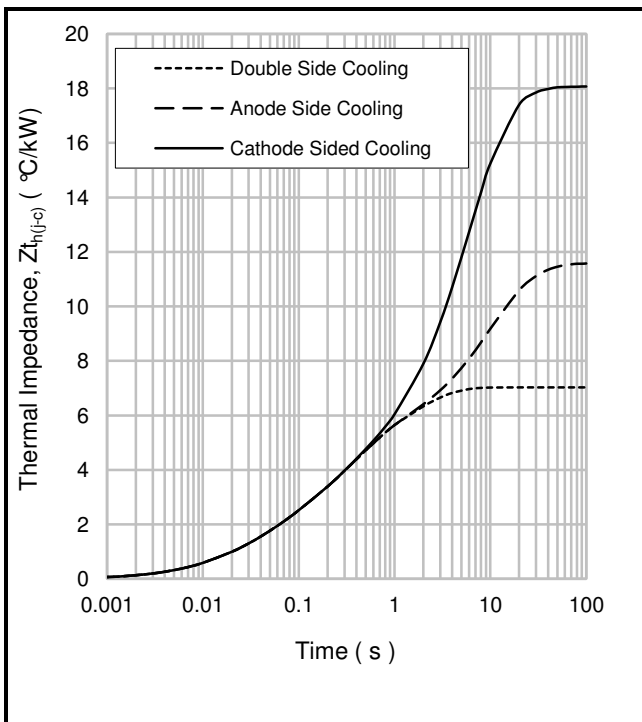

Fig.9 Maximum (limit) transient thermal impedance – junction to case (°C/kW)

		1	2	3	4
Double side cooled	R_i (°C/kW)	0.502	1.333	2.9559	2.2335
	T_i (s)	0.0137081	0.0548877	0.3311925	1.6905
Anode side cooled	R_i (°C/kW)	1.3035	3.138	1.1859	5.9136
	T_i (s)	0.0251065	0.2410256	1.0806	11.002
Cathode side cooled	R_i (°C/kW)	1.2616	2.6216	13.3603	0.8304
	T_i (s)	0.0245837	0.2005035	5.7854	16.765

$$Z_{th} = \sum [R_i \times (1 - \exp.(-t/t_i))] \quad [1]$$

$\Delta R_{th(j-c)}$ Conduction

Tables show the increments of thermal resistance $R_{th(j-c)}$ when the device operates at conduction angles other than d.c.

	Double side cooling		Anode Side Cooling		Cathode Sided Cooling	
	$\Delta Z_{th}(z)$		$\Delta Z_{th}(z)$		$\Delta Z_{th}(z)$	
θ°	sine.	rect.	sine.	rect.	sine.	rect.
180	0.70	0.48	0.67	0.47	0.67	0.47
120	0.80	0.68	0.77	0.66	0.77	0.66
90	0.90	0.78	0.87	0.75	0.87	0.76
60	1.00	0.89	0.95	0.86	0.95	0.86
30	1.07	1.01	1.02	0.96	1.02	0.96
15	1.10	1.07	1.05	1.02	1.05	1.02

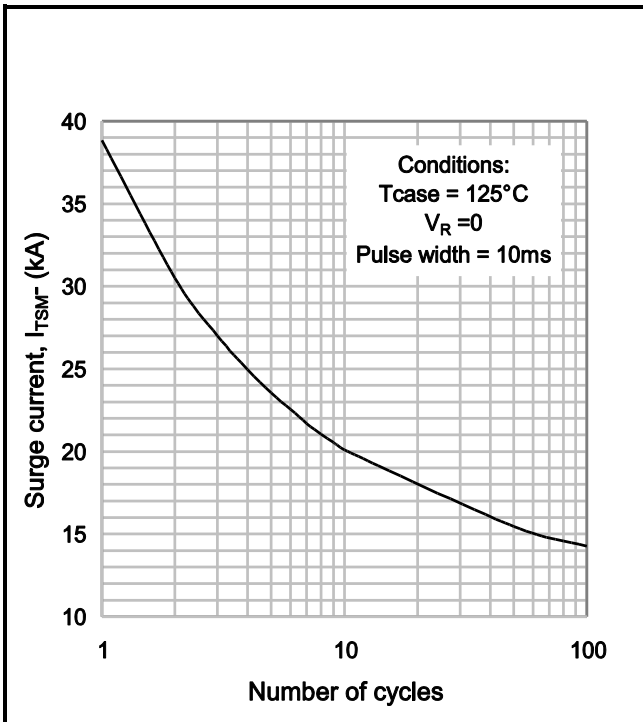

Fig.10 Multi-cycle surge current

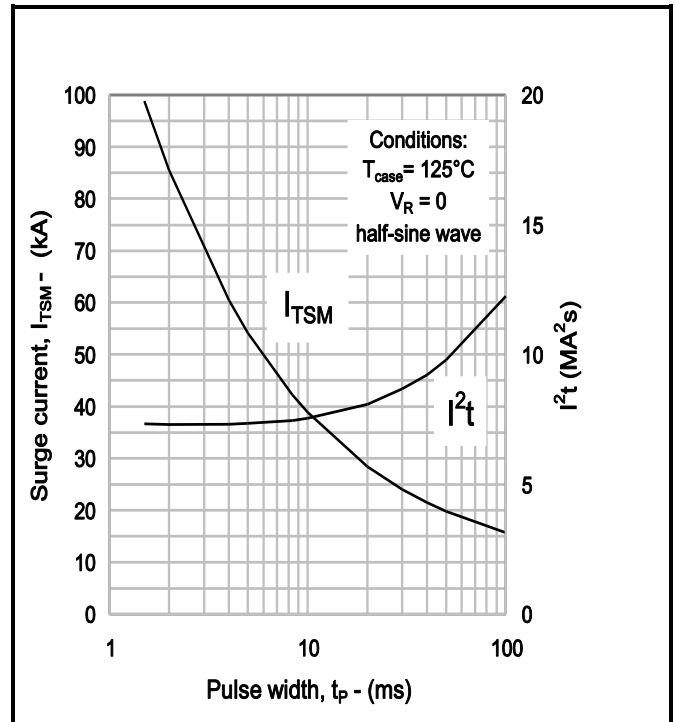

Fig.11 Single-cycle surge current

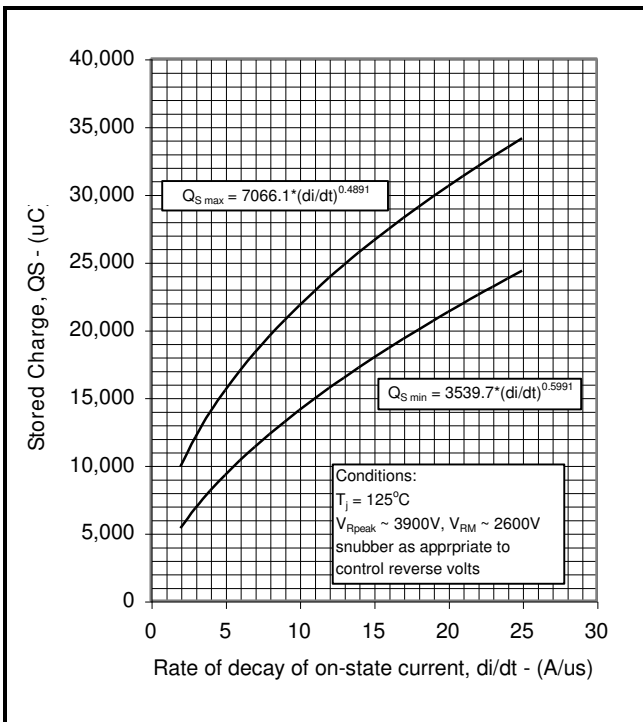

Fig.10 Reverse recovery charge

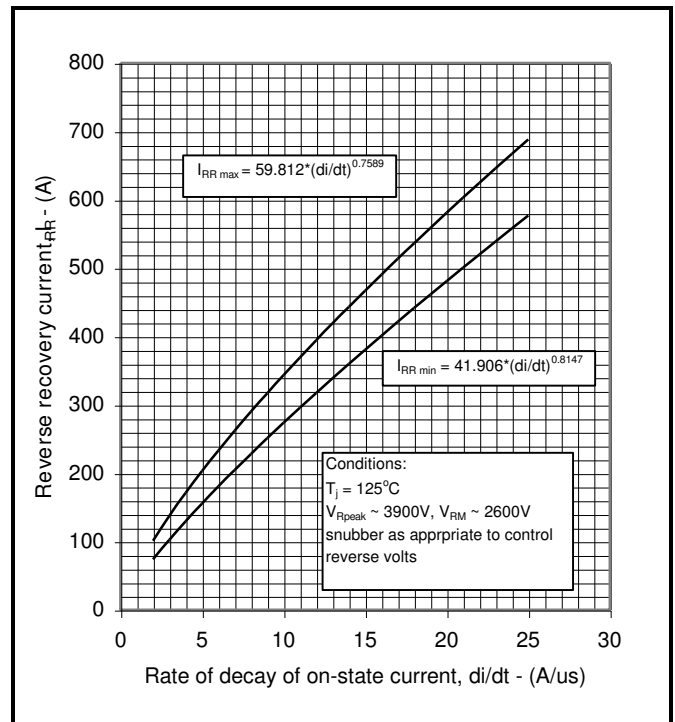

Fig.11 Reverse recovery current

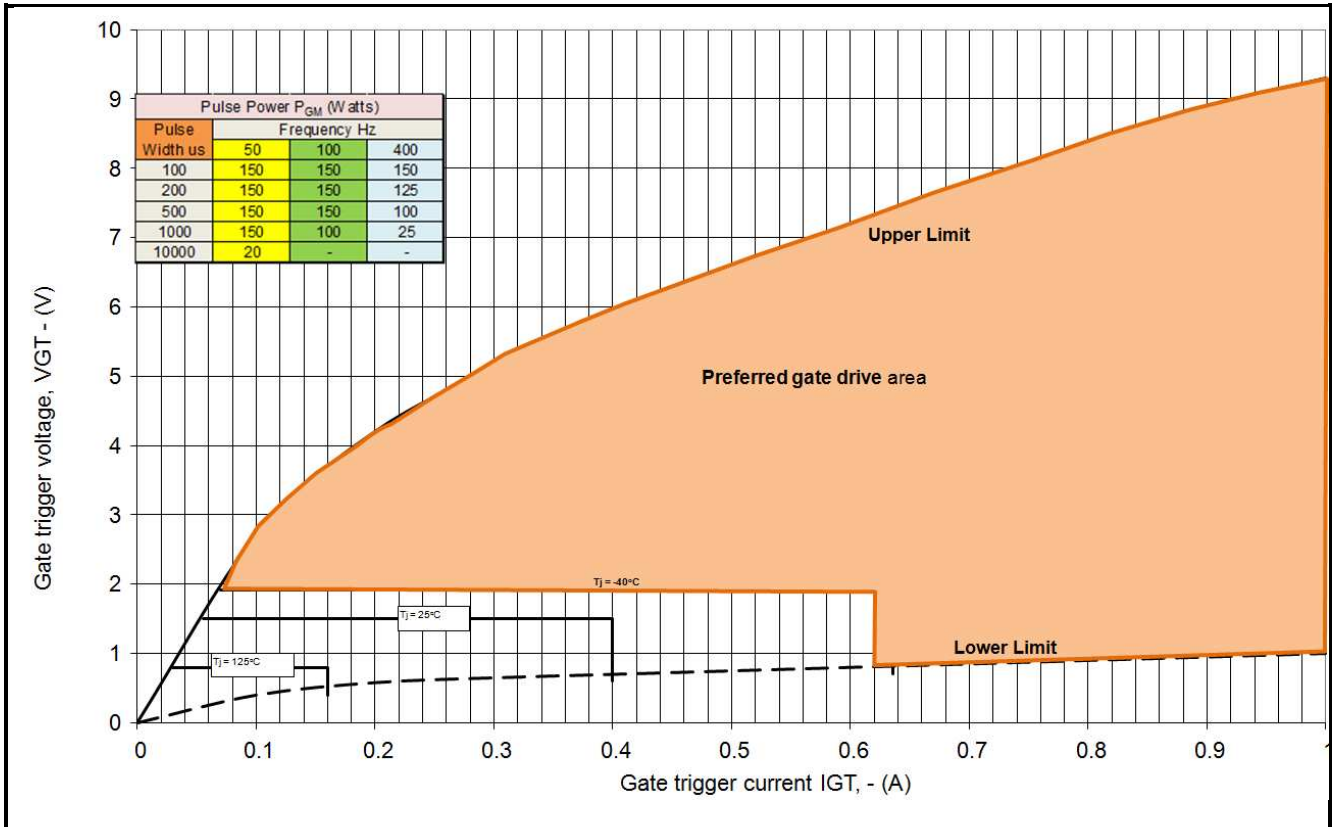

Fig12 Gate Characteristics

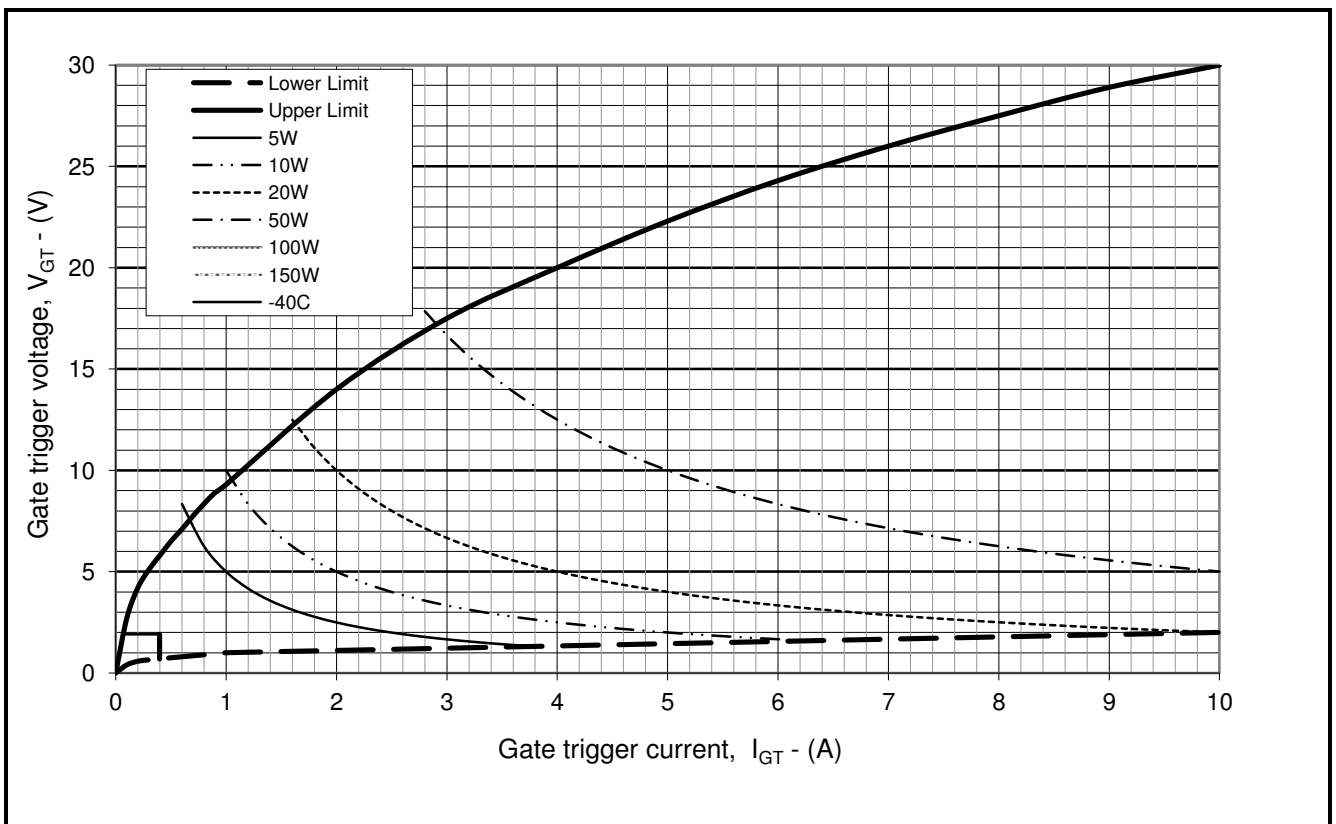

Fig. 13 Gate characteristics

PACKAGE DETAILS

For further package information, please contact Customer Services. All dimensions in mm, unless stated otherwise. **DO NOT SCALE.**

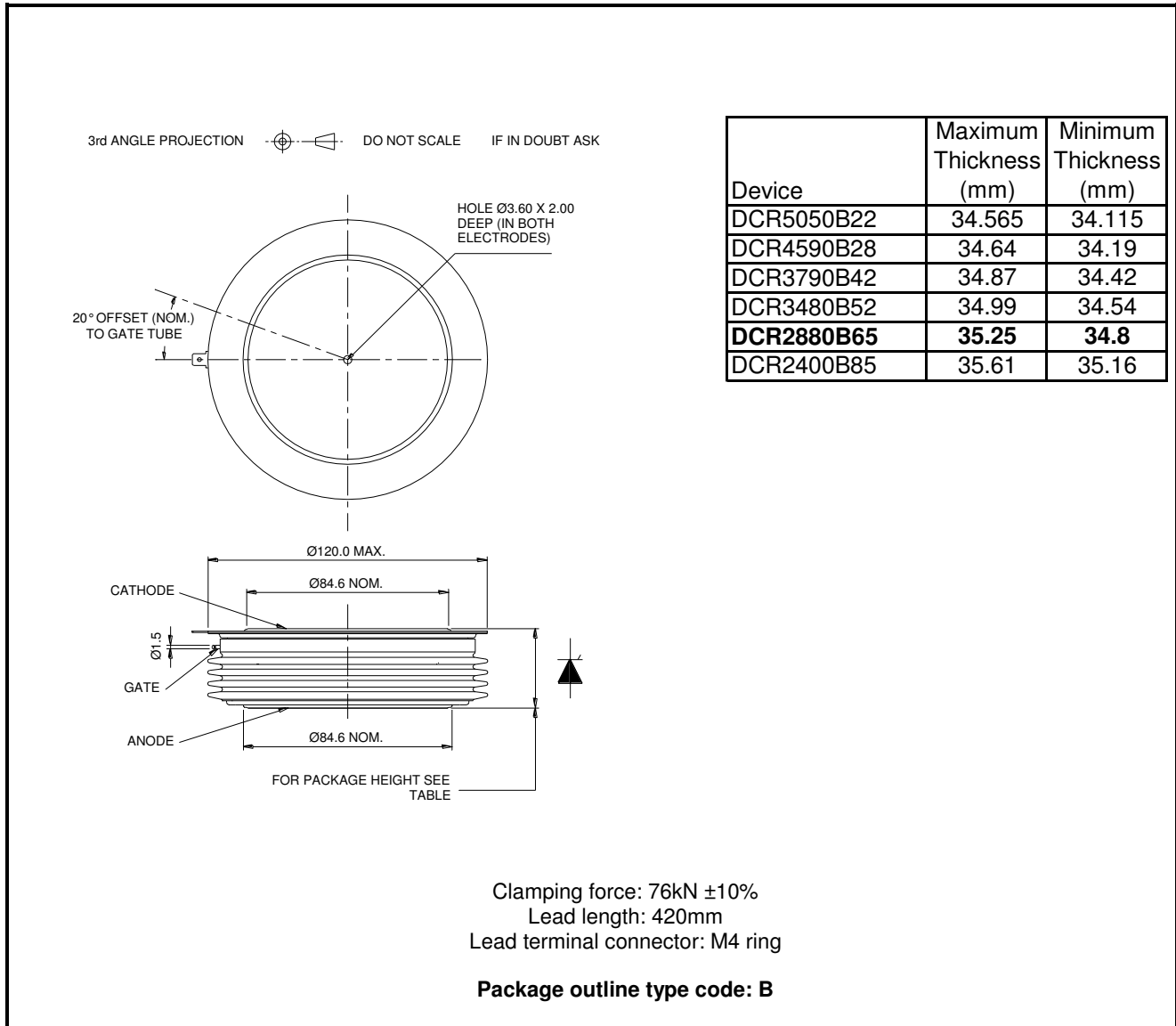

Fig.14 Package outline

IMPORTANT INFORMATION:

This publication is provided for information only and not for resale.

The products and information in this publication are intended for use by appropriately trained technical personnel.

Due to the diversity of product applications, the information contained herein is provided as a general guide only and does not constitute any guarantee of suitability for use in a specific application. The user must evaluate the suitability of the product and the completeness of the product data for the application. The user is responsible for product selection and ensuring all safety and any warning requirements are met. Should additional product information be needed please contact Customer Service.

Although we have endeavoured to carefully compile the information in this publication it may contain inaccuracies or typographical errors. The information is provided without any warranty or guarantee of any kind.

This publication is an uncontrolled document and is subject to change without notice. When referring to it please ensure that it is the most up to date version and has not been superseded.

The products are not intended for use in applications where a failure or malfunction may cause loss of life, injury or damage to property. The user must ensure that appropriate safety precautions are taken to prevent or mitigate the consequences of a product failure or malfunction.

The products must not be touched when operating because there is a danger of electrocution or severe burning. Always use protective safety equipment such as appropriate shields for the product and wear safety glasses. Even when disconnected any electric charge remaining in the product must be discharged and allowed to cool before safe handling using protective gloves.

Extended exposure to conditions outside the product ratings may affect reliability leading to premature product failure. Use outside the product ratings is likely to cause permanent damage to the product. In extreme conditions, as with all semiconductors, this may include potentially hazardous rupture, a large current to flow or high voltage arcing, resulting in fire or explosion. Appropriate application design and safety precautions should always be followed to protect persons and property.

Product Status & Product Ordering:

We annotate datasheets in the top right hand corner of the front page, to indicate product status if it is not yet fully approved for production. The annotations are as follows:-

Target Information:	This is the most tentative form of information and represents a very preliminary specification. No actual design work on the product has been started.
Provisional Information:	Some initial development work has been performed. The datasheet represents a view of the end product based on very limited information. Certain details will change.
Preliminary Information:	The product design is complete and final characterisation for volume production is in progress. The datasheet represents the product as it is now understood but details may change.
No Annotation:	The product has been approved for production and unless otherwise notified by Dynex any product ordered will be supplied to the current version of the data sheet prevailing at the time of our order acknowledgement.

All products and materials are sold and services provided subject to Dynex's conditions of sale, which are available on request.

Any brand names and product names used in this publication are trademarks, registered trademarks or trade names of their respective owners.

HEADQUARTERS OPERATIONS

DYNEX SEMICONDUCTOR LIMITED
Doddington Road, Lincoln, Lincolnshire, LN6 3LF
United Kingdom.
Phone: +44 (0) 1522 500500
Fax: +44 (0) 1522 500550
Web: <http://www.dynexsemi.com>

CUSTOMER SERVICE

Phone: +44 (0) 1522 502753 / 502901
Fax: +44 (0) 1522 500020
e-mail: power_solutions@dynexsemi.com