



### FEATURES

- Double Side Cooling
- High Surge Capability

### APPLICATIONS

- High Power Drives
- High Voltage Power Supplies
- Static Switches

### VOLTAGE RATINGS

Part and Ordering Number	Repetitive Peak Voltages $V_{DRM}$ and $V_{RRM}$ V	Conditions
DCR590G65*	6500	$T_{vj} = -40^{\circ}\text{C}$ to $125^{\circ}\text{C}$ , $I_{DRM} = I_{RRM} = 100\text{mA}$ , $V_{DRM}, V_{RRM} t_p = 10\text{ms}$ , $V_{DSM}$ & $V_{RSM} =$ $V_{DRM}$ & $V_{RRM} + 100\text{V}$ respectively
DCR590G60	6000	
DCR590G55	5500	

Lower voltage grades available.  
 \*6200V @  $-40^{\circ}\text{C}$ , 6500V @  $0^{\circ}\text{C}$

### KEY PARAMETERS

$V_{DRM}$	<b>6500V</b>
$I_{T(AV)}$	<b>595A</b>
$I_{TSM}$	<b>6600A</b>
$dV/dt^*$	<b>1500V/<math>\mu\text{s}</math></b>
$dI/dt$	<b>200A/<math>\mu\text{s}</math></b>

\* Higher  $dV/dt$  selections available

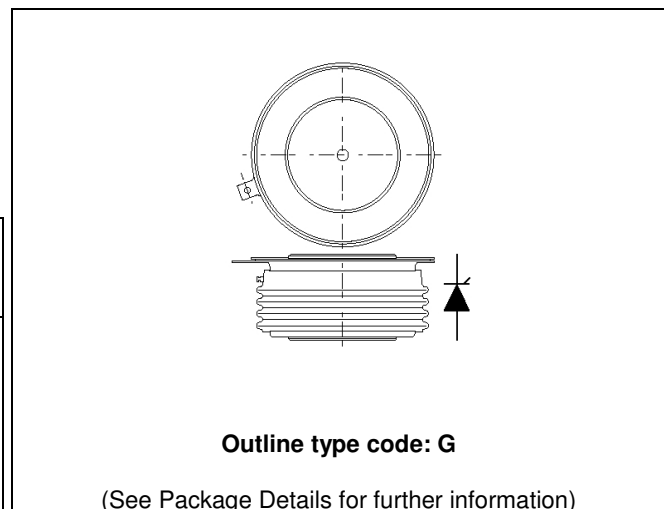

Outline type code: G

(See Package Details for further information)

Fig. 1 Package outline

### ORDERING INFORMATION

When ordering, select the required part number shown in the Voltage Ratings selection table.

For example:

#### DCR590G65

Note: Please use the complete part number when ordering and quote this number in any future correspondence relating to your order.

## CURRENT RATINGS

$T_{case} = 60^{\circ}C$  unless stated otherwise

Symbol	Parameter	Test Conditions	Max.	Units
<b>Double Side Cooled</b>				
$I_{T(AV)}$	Mean on-state current	Half wave resistive load	595	A
$I_{T(RMS)}$	RMS value	-	935	A
$I_T$	Continuous (direct) on-state current	-	912	A

## SURGE RATINGS

Symbol	Parameter	Test Conditions	Max.	Units
$I_{TSM}$	Surge (non-repetitive) on-state current	10ms half sine, $T_{case} = 125^{\circ}C$	6.6	kA
$I^2t$	$I^2t$ for fusing	$V_R = 0$	0.22	MA <sup>2</sup> s

## THERMAL AND MECHANICAL RATINGS

Symbol	Parameter	Test Conditions	Min.	Max.	Units	
$R_{th(j-c)}$	Thermal resistance – junction to case	Double side cooled	DC	-	0.0268	$^{\circ}C/W$
		Single side cooled	Anode DC	-	0.0527	$^{\circ}C/W$
			Cathode DC	-	0.0652	$^{\circ}C/W$
$R_{th(c-h)}$	Thermal resistance – case to heatsink	Clamping force 11.5kN (with mounting compound)	Double side	-	0.0072	$^{\circ}C/W$
			Single side	-	0.0144	$^{\circ}C/W$
$T_{vj}$	Virtual junction temperature	On-state (conducting)	-	135	$^{\circ}C$	
		Reverse (blocking)	-	125	$^{\circ}C$	
$T_{stg}$	Storage temperature range		-55	125	$^{\circ}C$	
$F_m$	Clamping force		10	13	kN	

**DYNAMIC CHARACTERISTICS**

Symbol	Parameter	Test Conditions	Min.	Max.	Units	
$I_{RRM}/I_{DRM}$	Peak reverse and off-state current	At $V_{RRM}/V_{DRM}$ , $T_{case} = 125^{\circ}C$	-	100	mA	
$dV/dt$	Max. linear rate of rise of off-state voltage	To 67% $V_{DRM}$ , $T_j = 125^{\circ}C$ , gate open	-	1500	V/ $\mu s$	
$dl/dt$	Rate of rise of on-state current	From 67% $V_{DRM}$ to $2x I_{T(AV)}$ Gate source 30V, 10 $\Omega$ , $t_r < 0.5\mu s$ , $T_j = 125^{\circ}C$	Repetitive 50Hz	-	100	A/ $\mu s$
			Non-repetitive	-	200	A/ $\mu s$
$V_{T(TO)}$	Threshold voltage – Low level	50A to 400A at $T_{case} = 125^{\circ}C$	-	0.912	V	
	Threshold voltage – High level	400A to 1600A at $T_{case} = 125^{\circ}C$	-	1.108	V	
$r_T$	On-state slope resistance – Low level	50A to 400A at $T_{case} = 125^{\circ}C$	-	2.157	m $\Omega$	
	On-state slope resistance – High level	400A to 1600A at $T_{case} = 125^{\circ}C$	-	1.647	m $\Omega$	
$t_{gd}$	Delay time	$V_D = 67\% V_{DRM}$ , gate source 30V, 10 $\Omega$ $t_r = 0.5\mu s$ , $T_j = 25^{\circ}C$	-	3	$\mu s$	
$t_q$	Turn-off time	$I_T = 500A$ , $T_j = 125^{\circ}C$ , $V_R = 100V$ , $dl/dt = 5A/\mu s$ , $dV_{DR}/dt = 20V/\mu s$ linear	550	1100	$\mu s$	
$Q_S$	Stored charge	$I_T = 500A$ , $T_j = 125^{\circ}C$ , $dl/dt = 5A/\mu s$ ,	1800	2600	$\mu C$	
$I_{RR}$	Reverse recovery current	$I_T = 500A$ , $T_j = 125^{\circ}C$ , $dl/dt = 5A/\mu s$ ,	77	90	A	
$I_L$	Latching current	$T_j = 25^{\circ}C$ , $V_D = 5V$	-	3	A	
$I_H$	Holding current	$T_j = 25^{\circ}C$ , $R_{G-K} = \infty$ , $I_{TM} = 500A$ , $I_T = 5A$	-	300	mA	

**GATE TRIGGER CHARACTERISTICS AND RATINGS**

Symbol	Parameter	Test Conditions	Max.	Units
V <sub>GT</sub>	Gate trigger voltage	V <sub>DRM</sub> = 5V, T <sub>case</sub> = 25° C	1.5	V
V <sub>GD</sub>	Gate non-trigger voltage	At 50% V <sub>DRM</sub> , T <sub>case</sub> = 125° C	0.4	V
I <sub>GT</sub>	Gate trigger current	V <sub>DRM</sub> = 5V, T <sub>case</sub> = 25° C	250	mA
I <sub>GD</sub>	Gate non-trigger current	At 50% V <sub>DRM</sub> , T <sub>case</sub> = 125° C	15	mA

**CURVES**

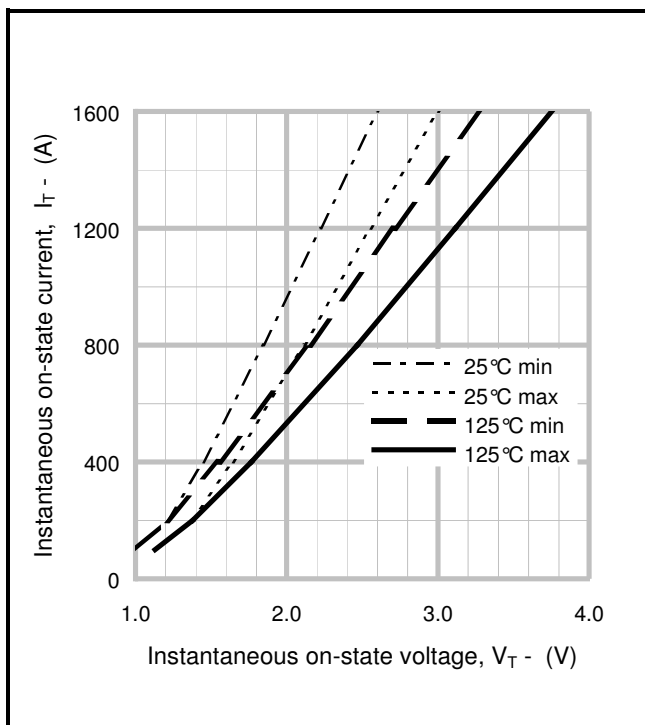

**Fig.2 Maximum & minimum on-state characteristics**

**V<sub>TM</sub> EQUATION**

$$V_{TM} = A + B \ln(I_T) + C \cdot I_T + D \cdot \sqrt{I_T}$$

Where A = 0.542452  
 B = 0.065613  
 C = 0.001318  
 D = 0.015356

these values are valid for T<sub>j</sub> = 125° C for I<sub>T</sub> 50A to 1600A

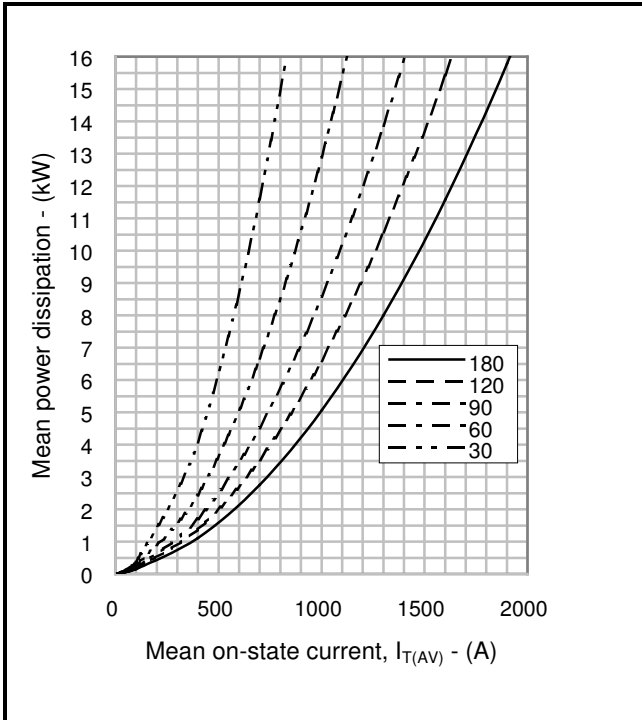

**Fig.3 On-state power dissipation – sine wave**

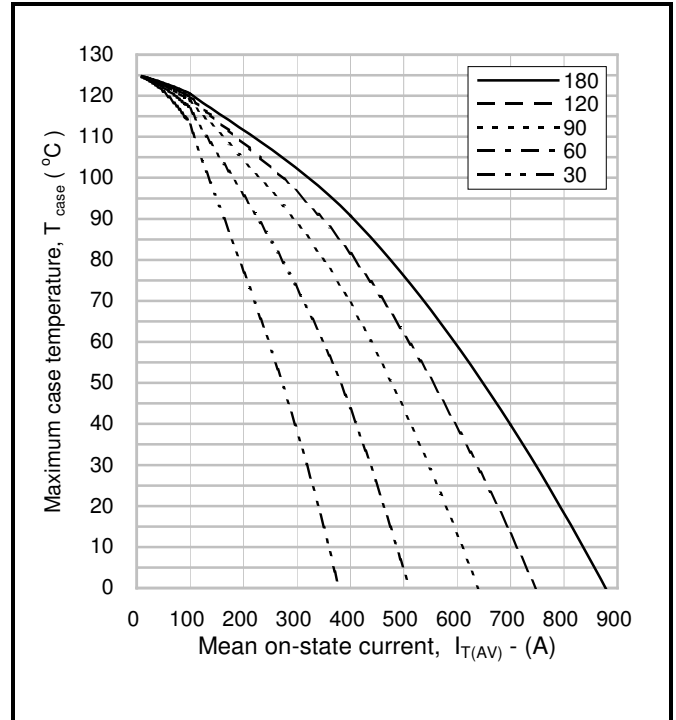

**Fig.4 Maximum permissible case temperature, double side cooled – sine wave**

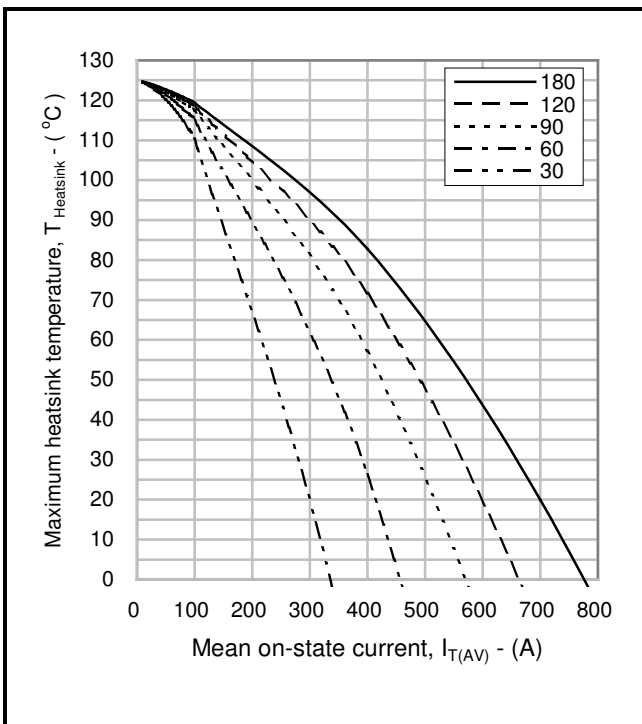

**Fig.5 Maximum permissible heatsink temperature, double side cooled – sine wave**

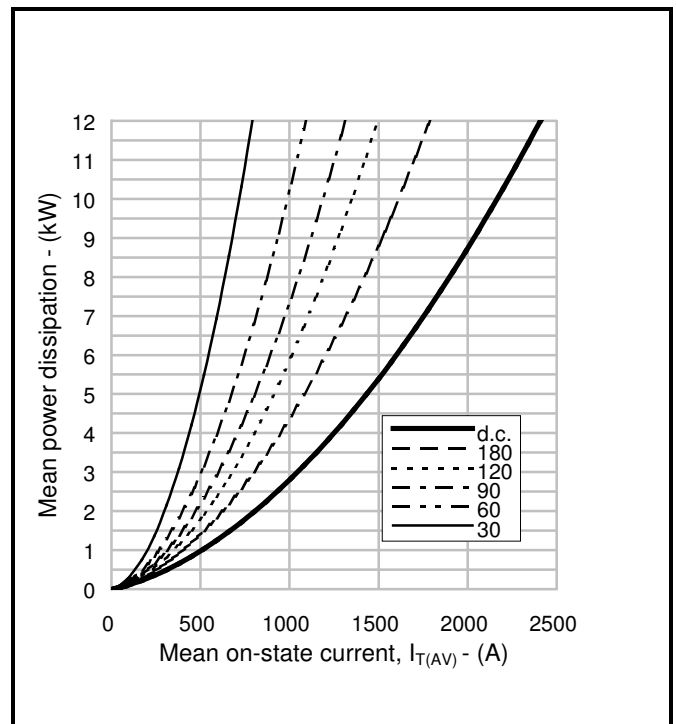

**Fig.6 On-state power dissipation – rectangular wave**

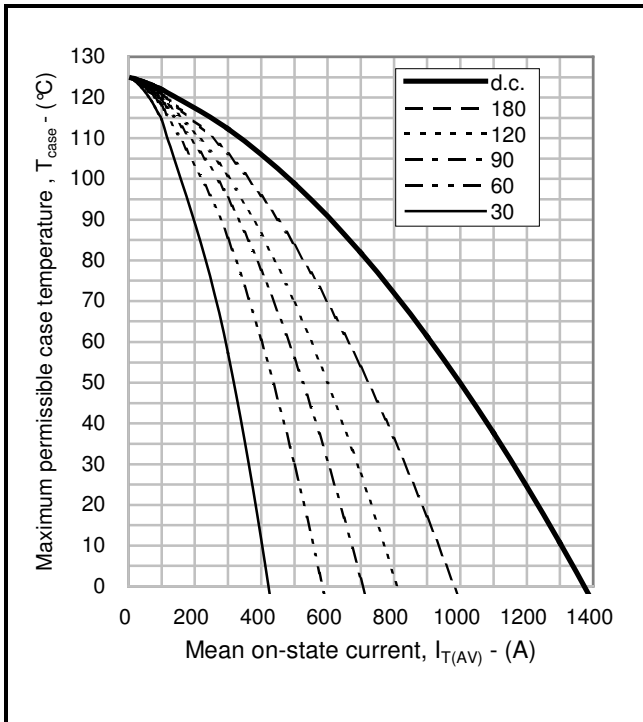

**Fig.7 Maximum permissible case temperature, double side cooled – rectangular wave**

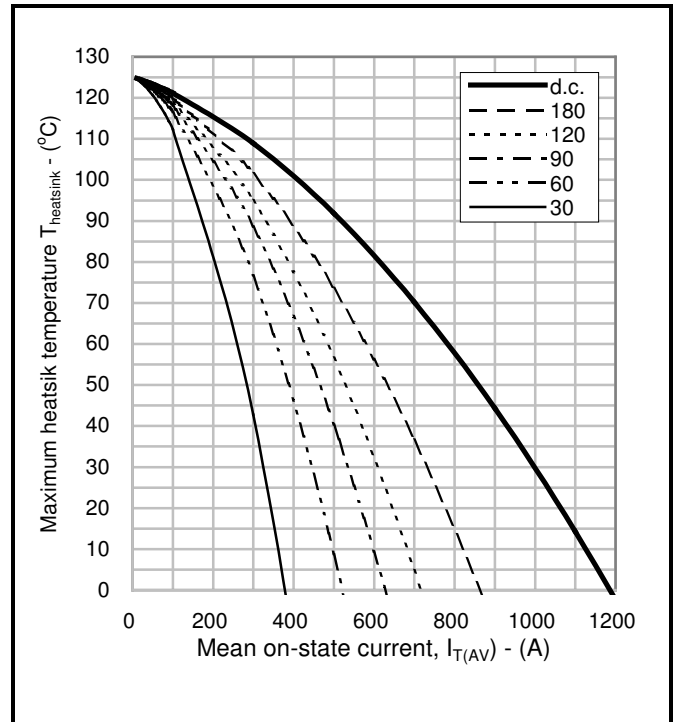

**Fig.8 Maximum permissible heatsink temperature, double side cooled – rectangular wave**

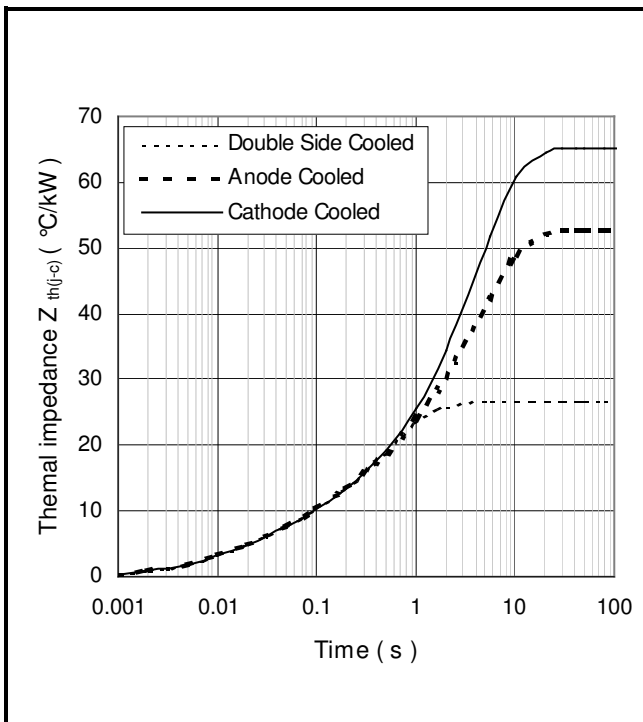

**Fig.9 Maximum (limit) transient thermal impedance – junction to case (°C/kW)**

		1	2	3	4
Double side cooled	R <sub>i</sub> (°C/kW)	2.2995	5.4226	16.9074	2.1488
	T <sub>i</sub> (s)	0.0066401	0.0457025	0.4962482	1.8248
Anode side cooled	R <sub>i</sub> (°C/kW)	2.3214	5.2661	10.2686	34.8031
	T <sub>i</sub> (s)	0.0066948	0.045528	0.3484209	4.582
Cathode side cooled	R <sub>i</sub> (°C/kW)	2.4895	5.9105	7.4256	49.3432
	T <sub>i</sub> (s)	0.0070404	0.052895	0.3933903	4.2295

$$Z_{th} = \sum [R_i \times (1 - \exp.(-t/t_i))] \quad [1]$$

$\Delta R_{th(j-c)}$  Conduction

Tables show the increments of thermal resistance  $R_{th(j-c)}$  when the device operates at conduction angles other than d.c.

Double side cooling			Anode Side Cooling			Cathode Sided Cooling		
$\theta^\circ$	$\Delta Z_{th} (z)$		$\theta^\circ$	$\Delta Z_{th} (z)$		$\theta^\circ$	$\Delta Z_{th} (z)$	
	sine.	rect.		sine.	rect.		sine.	rect.
180	4.15	2.72	180	4.15	2.72	180	4.13	2.71
120	4.90	4.02	120	4.89	4.02	120	4.87	4.00
90	5.74	4.79	90	5.73	4.78	90	5.69	4.76
60	6.53	5.65	60	6.52	5.65	60	6.46	5.60
30	7.16	6.64	30	7.15	6.62	30	7.07	6.56
15	7.46	7.18	15	7.44	7.16	15	7.36	7.09

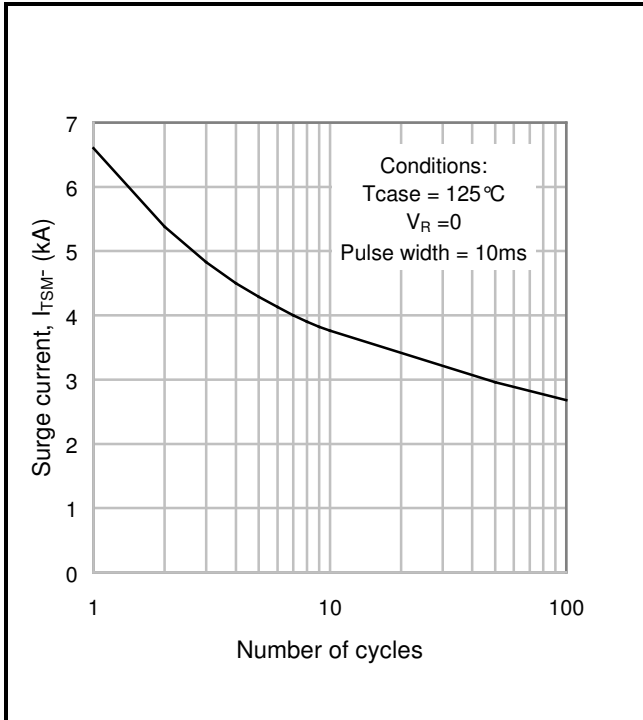

Fig.10 Multi-cycle surge current

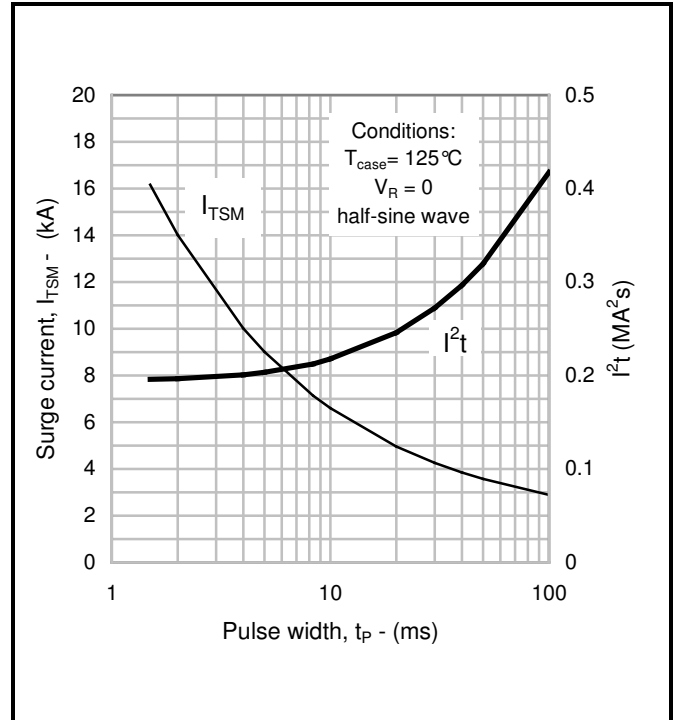

Fig.11 Single-cycle surge current

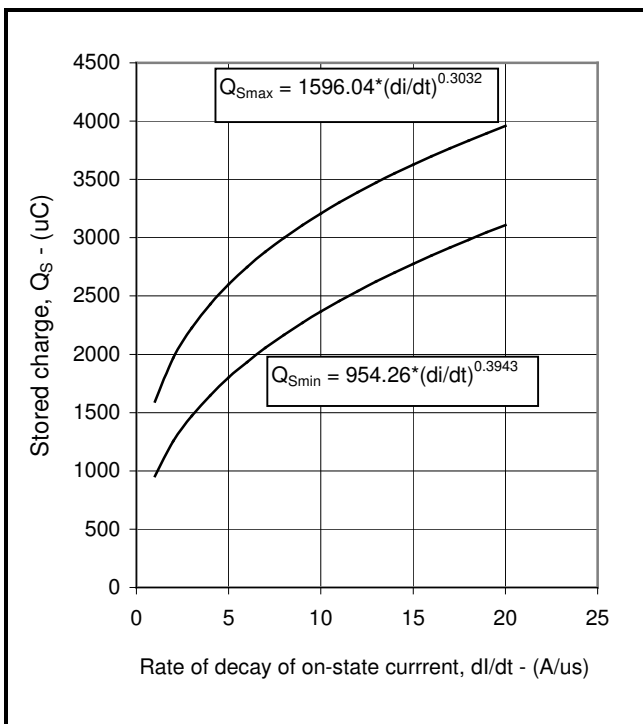

Fig.12 Stored charge vs di/dt

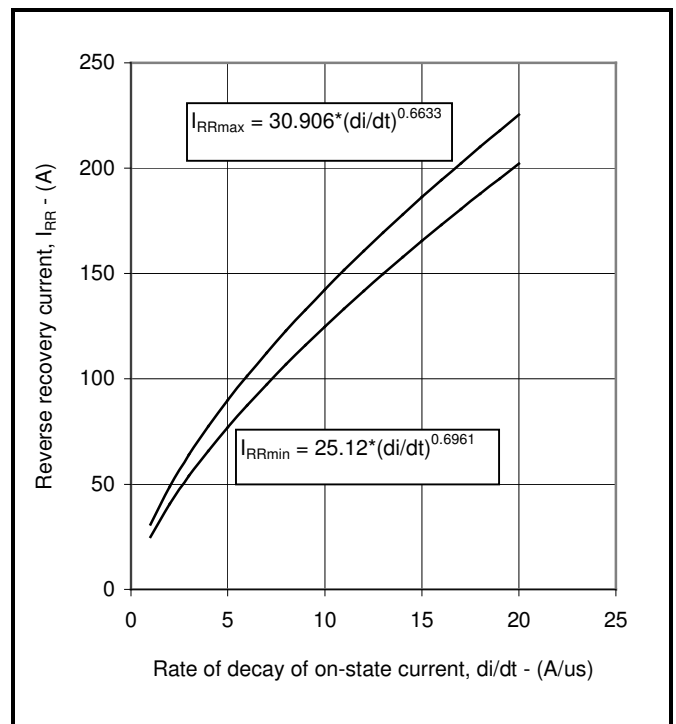

Fig.13 Reverse recovery current vs di/dt

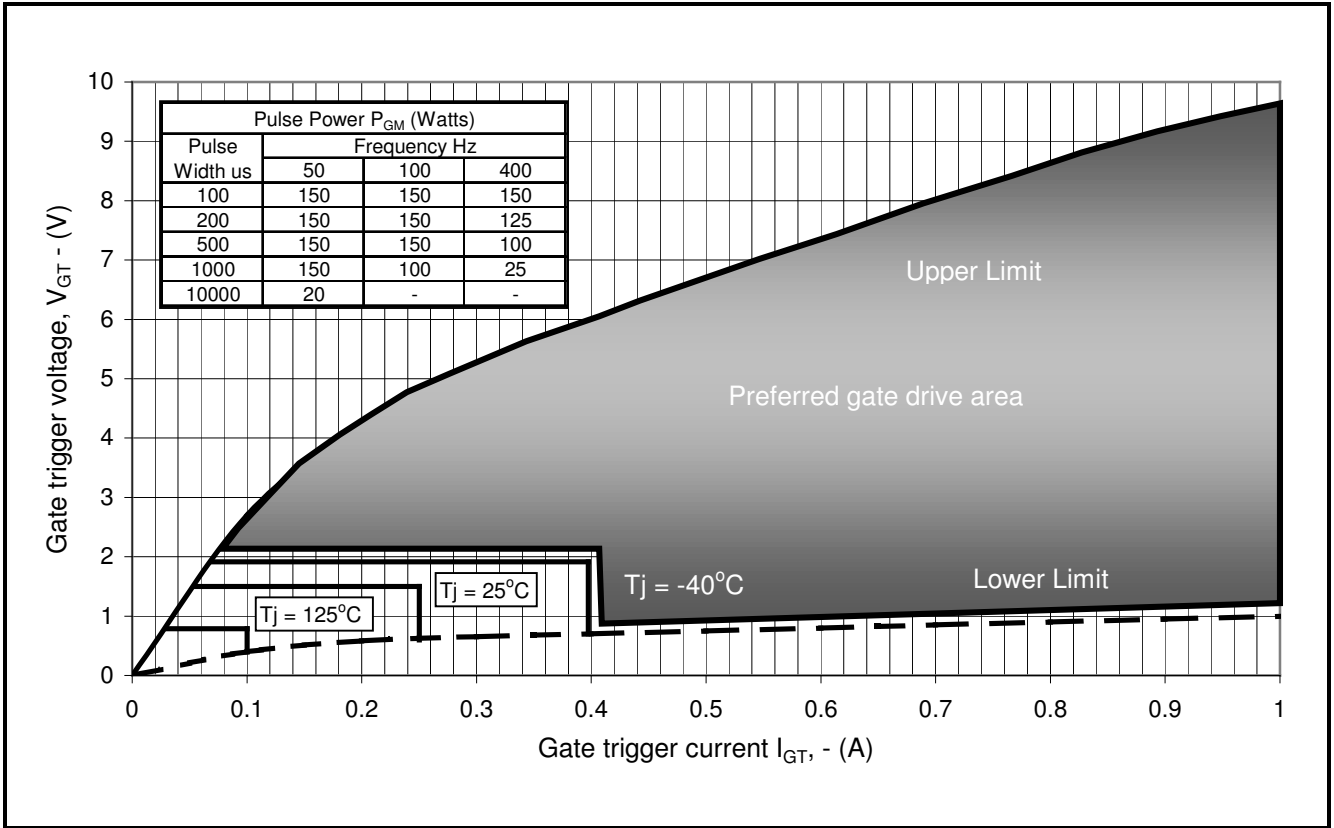

Fig14 Gate Characteristics

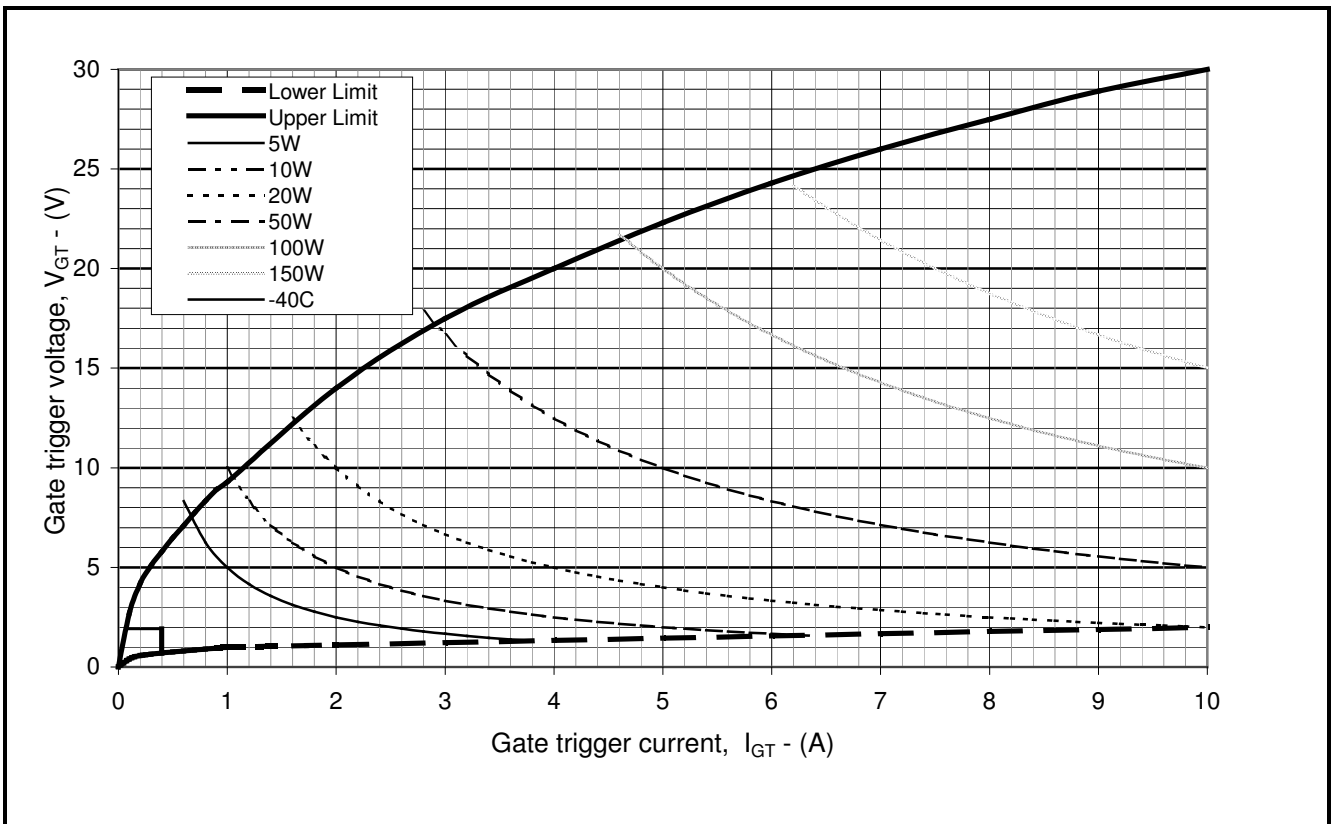
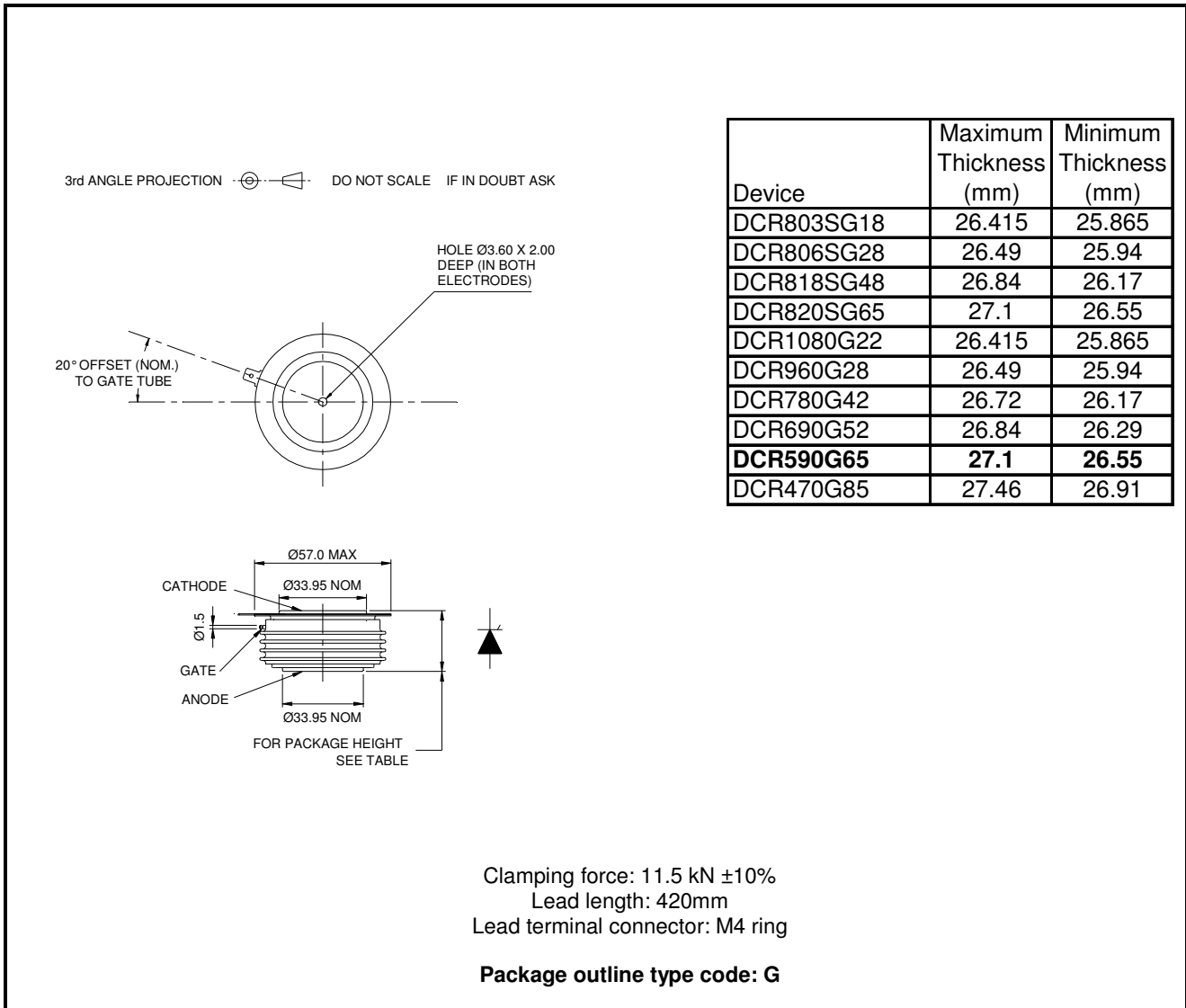

Fig. 15 Gate characteristics

**PACKAGE DETAILS**

For further package information, please contact Customer Services. All dimensions in mm, unless stated otherwise. DO NOT SCALE.



**Fig.16 Package outline**

## **POWER ASSEMBLY CAPABILITY**

The Power Assembly group was set up to provide a support service for those customers requiring more than the basic semiconductor, and has developed a flexible range of heatsink and clamping systems in line with advances in device voltages and current capability of our semiconductors.

We offer an extensive range of air and liquid cooled assemblies covering the full range of circuit designs in general use today. The Assembly group offers high quality engineering support dedicated to designing new units to satisfy the growing needs of our customers.

Using the latest CAD methods our team of design and applications engineers aim to provide the Power Assembly Complete Solution (PACs).

## **HEATSINKS**

The Power Assembly group has its own proprietary range of extruded aluminium heatsinks which have been designed to optimise the performance of Dynex semiconductors. Data with respect to air natural, forced air and liquid cooling (with flow rates) is available on request.

For further information on device clamps, heatsinks and assemblies, please contact your nearest sales representative or Customer Services.

Stresses above those listed in this data sheet may cause permanent damage to the device. In extreme conditions, as with all semiconductors, this may include potentially hazardous rupture of the package. Appropriate safety precautions should always be followed.



<http://www.dynexsemi.com>

**e-mail: [power\\_solutions@dynexsemi.com](mailto:power_solutions@dynexsemi.com)**

**HEADQUARTERS OPERATIONS  
DYNEX SEMICONDUCTOR LTD**  
Doddington Road, Lincoln  
Lincolnshire, LN6 3LF. United Kingdom.  
Tel: +44(0)1522 500500  
Fax: +44(0)1522 500550

**CUSTOMER SERVICE**  
Tel: +44(0)1522 502753 / 502901. Fax: +44(0)1522 500020

© Dynex Semiconductor 2003 TECHNICAL DOCUMENTATION – NOT FOR  
RESALE. PRODUCED IN UNITED KINGDOM.

This publication is issued to provide information only which (unless agreed by the Company in writing) may not be used, applied or reproduced for any purpose nor form part of any order or contract nor to be regarded as a representation relating to the products or services concerned. No warranty or guarantee express or implied is made regarding the capability, performance or suitability of any product or service. The Company reserves the right to alter without prior notice the specification, design or price of any product or service. Information concerning possible methods of use is provided as a guide only and does not constitute any guarantee that such methods of use will be satisfactory in a specific piece of equipment. It is the user's responsibility to fully determine the performance and suitability of any equipment using such information and to ensure that any publication or data used is up to date and has not been superseded. These products are not suitable for use in any medical products whose failure to perform may result in significant injury or death to the user. All products and materials are sold and services provided subject to the Company's conditions of sale, which are available on request.

All brand names and product names used in this publication are trademarks, registered trademarks or trade names of their respective owners.