

150mA Dual Regulator Monolithic IC MM3248 □ Series

Outline

This IC is a 2-circuit type of MM324x series that is a low saturation regulator IC with 150mA output realizing low current consumption, low noise, and high ripple rejection using a CMOS process. The output voltage of the regulator is fixed and can be programmed between 1.5V and 5.0V upon request. It provides a switch pin to control each output and is an ideal IC for the portable equipment.

Features

- | | |
|---|------------------------------------|
| 1. Current consumption (during off-state) | 0.02μA |
| 2. High accuracy output voltage | ±1.0% |
| 3. Dropout voltage | 0.13V typ. (I _o =100mA) |
| 4. High ripple rejection | 77dB typ. |
| 5. Operating temperature range | -40 to +85°C |
| 6. Output voltage | 1.5 to 5.0V (0.1V steps) |
| 7. Output capacitor | 0.1μF (Ceramic) |

Package

SSON-6

Applications

1. Cordless phones
2. Portable players
3. Digital still cameras
4. Portable game devices
5. PDAs

Pin Assignment

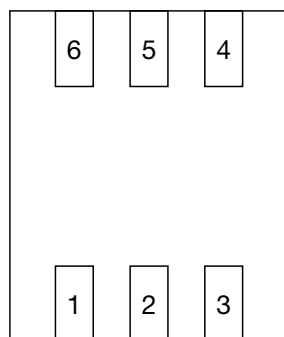

SSON-6
(TOP VIEW)

1	V _{O2}
2	V _{DD}
3	V _{O1}
4	GND
5	CE1
6	CE2

Block Diagram

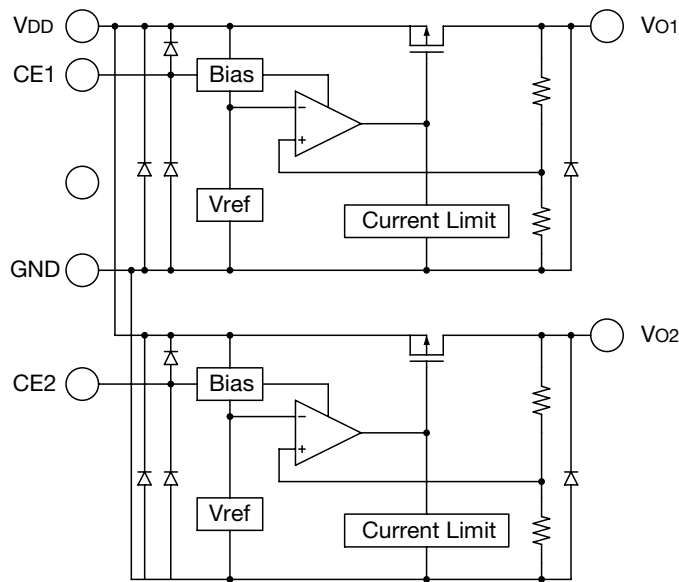

Pin Description

Pin No.	Pin name	Function						
SSON-6								
1	VO2	Output pin 2						
2	VDD	Voltage-supply pin						
3	VO1	Output pin 1						
4	GND	Ground						
5, 6	CE1, CE2	ON/OFF-Control pin <table border="1" style="margin: 10px auto;"> <tr> <td>CE</td> <td>V_{OUT}</td> </tr> <tr> <td>L</td> <td>OFF</td> </tr> <tr> <td>H</td> <td>ON</td> </tr> </table> <p>Connect CE pin with V_{DD} pin, when it is not used.</p>	CE	V _{OUT}	L	OFF	H	ON
CE	V _{OUT}							
L	OFF							
H	ON							

Absolute Maximum Ratings (Ta=25°C)

Item	Symbol	Ratings	Units
Storage temperature	T _{STG}	-55~+150	°C
Supply voltage	V _{DD}	-0.3~+7.0	V
CE input voltage	V _{CE}	-0.3~+7.0	V
Output voltage	V _O	-0.3~V _{DD} +0.3	V
Output current	I _{omax}	200	mA
Power dissipation *1	P _d	1300 *1 180 (Alone)	mW

Note1: *1 With the double sided PC Board of glass epoxy. (25×25×1.6mm copper plane 80%)

• Any products mentioned in this catalog are subject to any modification in their appearance and others for improvements without prior notification.
 • The details listed here are not a guarantee of the individual products at the time of ordering. When using the products, you will be asked to check their specifications.

Recommended Operating Conditions (Ta=25°C)

Item	Symbol	Ratings	Units
Operating ambient temperature	T _{JOP}	-40~+85	°C
Operating voltage	V _{OP}	2.0~6.0	V
Output current	I _O	0~150	mA

Electrical Characteristics 1 (Except where noted otherwise, Ta=25°C, V_{DD}=V_O (typ.)+1V, V_{CE}=V_{DD})

Item	Symbol	Measurement conditions	Min.	Typ.	Max.	Units
Input current 1(OFF)	I _{DDoff1}	V _{CE1} =V _{CE2} =0V		0.02	2.0	μA
No-Load input current 1	I _{DD1}	I _{O1} =0mA V _{CE2} =0V		10	18	μA
No-Load input current 2	I _{DD2}	I _{O2} =0mA V _{CE1} =0V		10	18	μA
V_{O1} Block						
Output voltage 1	V _{O1}	I _{O1} =30mA	×0.99		×0.01	V
Line regulation 1	V _{LINE1}	V _{DD} =V _{O1} (Typ.) +0.5~6V, I _{O1} =30mA (V _{O1} ≤ 1.6V, V _{DD} =2.2~6V)		0.01	0.2	%/V
Load regulation 1	V _{LOAD1}	1mA ≤ I _{O1} ≤ 80mA		15	50	mV
Dropout voltage 1	V _{iO1}	Please refer to Electrical Characteristics 2				V
Ripple rejection 1-1	RR ₁₋₁	f=1kHz, V _{ripple} =0.5V, I _{O1} =50mA 1.5V ≤ V _{O1} ≤ 5.5V		77		dB
Ripple rejection 1-2	RR ₁₋₂	f=10kHz, V _{ripple} =0.5V, I _{O1} =50mA 1.5V ≤ V _{O1} ≤ 5.5V		65		dB
V _{O1} temperature coefficient 1	ΔV _{O1} /ΔT	I _{O1} =30mA -40 ≤ Top ≤ 85°C		±100		ppm/°C
Output short-circuit current 1	I _{lim1}	V _{O1} =0V		50		mA
CE high threshold voltage 1	V _{CEH1}		1.5			V
CE low threshold voltage 1	V _{CEL1}				0.25	V
CE high threshold current 1	I _{CEH1}		-0.1		0.1	μA
CE low threshold current 1	I _{CEL1}		-0.1		0.1	μA
V_{O2} Block						
Output voltage 2	V _{O2}	I _{O2} =30mA	×0.99		×0.01	V
Line regulation 2	V _{LINE2}	V _{DD} =V _{O2} (Typ.) +0.5~6V, I _{O2} =30mA (V _{O2} ≤ 1.6V, V _{DD} =2.2~6V)		0.01	0.2	%/V
Load regulation 2	V _{LOAD2}	1mA ≤ I _{O2} ≤ 80mA		15	50	mV
Dropout voltage 2	V _{iO2}	Please refer to Electrical Characteristics 2				V
Ripple rejection 2-1	RR ₂₋₁	f=1kHz, V _{ripple} =0.5V, I _{O2} =50mA 1.5V ≤ V _{O2} ≤ 5.5V		77		dB
Ripple rejection 2-2	RR ₂₋₂	f=10kHz, V _{ripple} =0.5V, I _{O2} =50mA 1.5V ≤ V _{O2} ≤ 5.5V		65		dB
V _{O2} temperature coefficient 2	ΔV _{O2} /ΔT	I _{O2} =30mA -40 ≤ Top ≤ 85°C		±100		ppm/°C
Output short-circuit current 2	I _{lim2}	V _{O2} =0V		50		mA
CE high threshold voltage 2	V _{CEH2}		1.5			V
CE low threshold voltage 2	V _{CEL2}				0.25	V
CE high threshold current 2	I _{CEH2}		-0.1		0.1	μA
CE low threshold current 2	I _{CEL2}		-0.1		0.1	μA

• Any products mentioned in this catalog are subject to any modification in their appearance and others for improvements without prior notification.
 • The details listed here are not a guarantee of the individual products at the time of ordering. When using the products, you will be asked to check their specifications.

Electrical Characteristics 2 (Except where noted otherwise, $T_a=25^\circ\text{C}$, $V_{DD}=V_o$ (typ.) +1V, $V_{CE}=V_{DD}$)

Output voltage (V)	Item											
	Output voltage				Dropout voltage 1				Dropout voltage 2			
	V_o (V)				V_{io1} (V)				V_{io2} (V)			
	Measurement conditions	Min.	Typ.	Max.	Measurement conditions	Min.	Typ.	Max.	Measurement conditions	Min.	Typ.	Max.
1.5	$I_o=30\text{mA}$	1.485	1.500	1.515	$I_o=30\text{mA}$ $1.5\text{V} \leq V_o \leq 1.9\text{V}$		0.10	0.15	$I_o=100\text{mA}$ $1.5\text{V} \leq V_o \leq 1.9\text{V}$		0.60	0.80
1.6		1.584	1.600	1.616								
1.7		1.683	1.700	1.717								
1.8		1.782	1.800	1.818								
1.9		1.881	1.900	1.919								
2.0		1.980	2.000	2.020	$2.0\text{V} \leq V_o \leq 2.4\text{V}$		0.08	0.12	$2.0\text{V} \leq V_o \leq 2.4\text{V}$		0.24	0.31
2.1		2.079	2.100	2.121								
2.2		2.178	2.200	2.222								
2.3		2.277	2.300	2.323								
2.4		2.376	2.400	2.424								
2.5		2.475	2.500	2.525	$2.5\text{V} \leq V_o \leq 2.9\text{V}$		0.06	0.08	$2.5\text{V} \leq V_o \leq 2.9\text{V}$		0.16	0.23
2.6		2.574	2.600	2.626								
2.7		2.673	2.700	2.727								
2.8		2.772	2.800	2.828								
2.85		2.822	2.850	2.879								
2.9	2.871	2.900	2.929									
3.0		2.970	3.000	3.030	$3.0\text{V} \leq V_o \leq 3.2\text{V}$		0.05	0.07	$3.0\text{V} \leq V_o \leq 3.2\text{V}$		0.14	0.21
3.1		3.069	3.100	3.131								
3.2		3.168	3.200	3.232								
3.3		3.267	3.300	3.333	$3.3\text{V} \leq V_o \leq 5.0\text{V}$		0.04	0.06	$3.3\text{V} \leq V_o \leq 5.0\text{V}$		0.13	0.19
3.4		3.366	3.400	3.434								
3.5		3.465	3.500	3.535								
3.6		3.564	3.600	3.636								
3.7		3.663	3.700	3.737								
3.8		3.762	3.800	3.838								
3.9		3.861	3.900	3.939								
4.0		3.960	4.000	4.040								
4.1		4.059	4.100	4.141								
4.2		4.158	4.200	4.242								
4.3		4.257	4.300	4.343								
4.4		4.356	4.400	4.444								
4.5		4.455	4.500	4.545								
4.6		4.554	4.600	4.646								
4.7		4.653	4.700	4.747								
4.8	4.752	4.800	4.848									
4.9	4.851	4.900	4.949									
5.0	4.950	5.000	5.050									

• Any products mentioned in this catalog are subject to any modification in their appearance and others for improvements without prior notification.
 • The details listed here are not a guarantee of the individual products at the time of ordering. When using the products, you will be asked to check their specifications.

Measuring Circuit

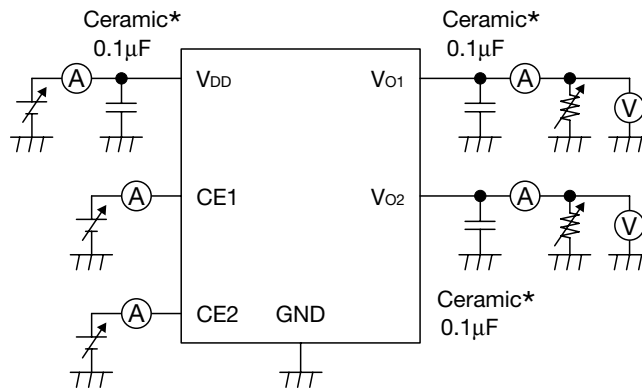

Application Circuit

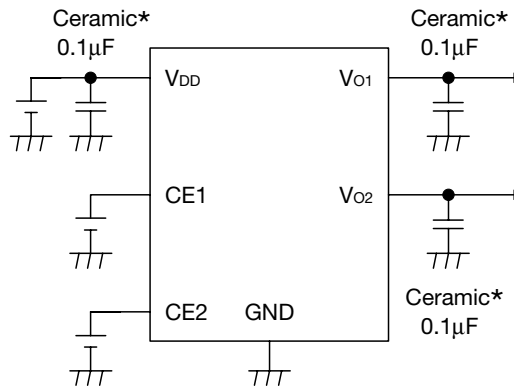

*Temperature Characteristics : B

Note

1. The output capacitor is required between output and GND to prevent the oscillation.
2. The output capacitor must be used in ESR stable area.
It is possible to use a ceramic capacitor without ESR resistance for output.
The ceramic capacitor must be used more than 0.1µF and B temperature characteristics.
3. The wire of V_{CC} and GND is required to print full ground plane for noise and stability.
4. The input capacitor must be connected in 1cm from input pin.
5. In case the output voltage is above the input voltage, the overcurrent flows by internal parastic diode from output to input.

Characteristics (Except where noted otherwise, $T_a=25^\circ\text{C}$, $V_{DD}=V_{OUT}(\text{typ.})+1\text{V}$, $V_{CE}=V_{DD}$)

■ Output-Input Voltage V_{o1}

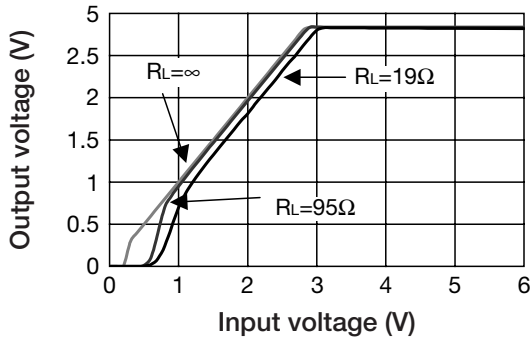

■ Output-Input Voltage V_{o2}

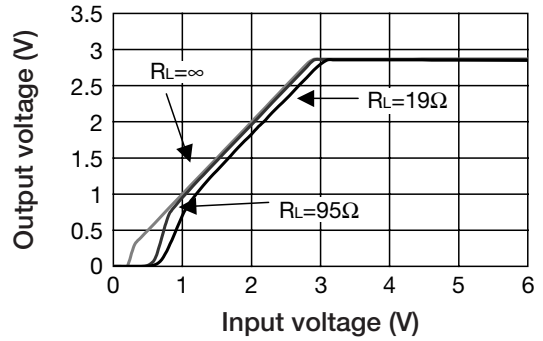

■ Load regulation V_{o1}

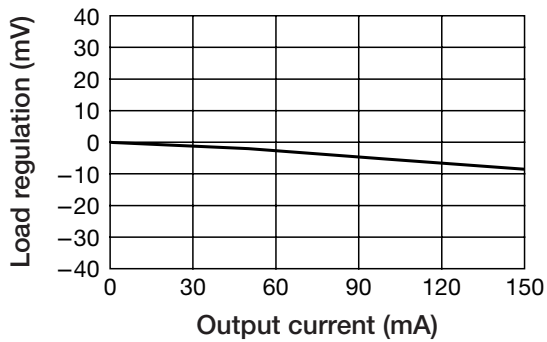

■ Load regulation V_{o2}

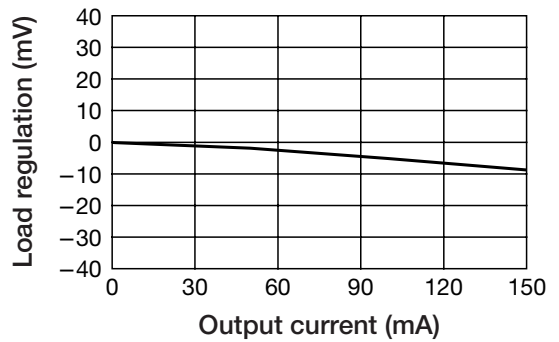

■ Line Regulation V_{o1}

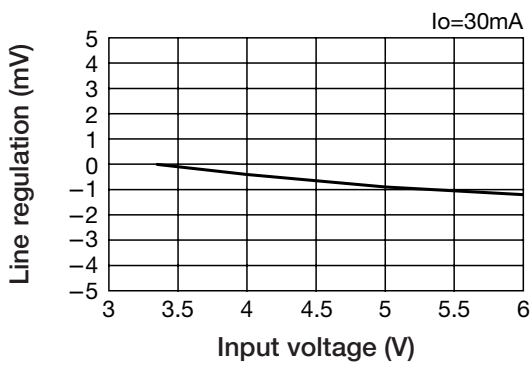

■ Line Regulation V_{o2}

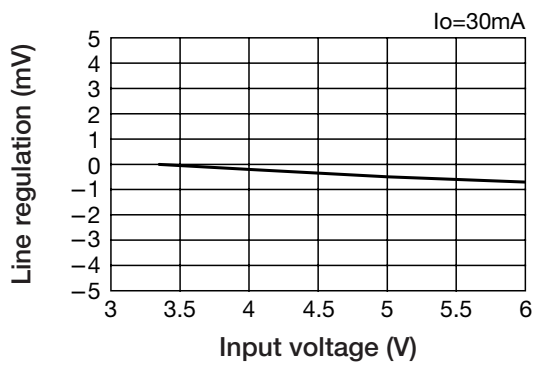

• Any products mentioned in this catalog are subject to any modification in their appearance and others for improvements without prior notification.
 • The details listed here are not a guarantee of the individual products at the time of ordering. When using the products, you will be asked to check their specifications.

■ Dropout Voltage-Output Current Vo1

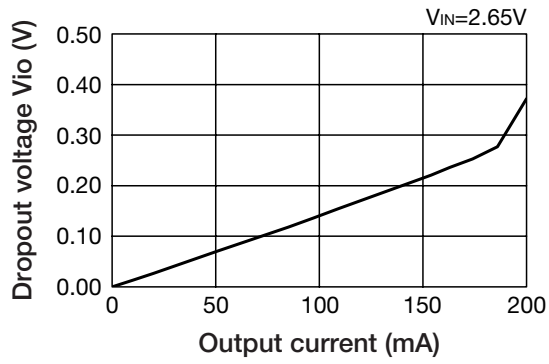

■ Dropout Voltage-Output Current Vo2

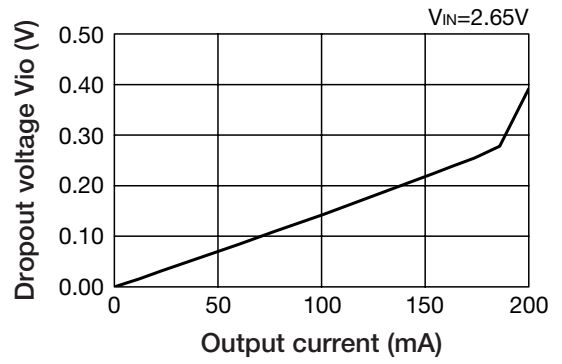

■ Current Limit Vo1

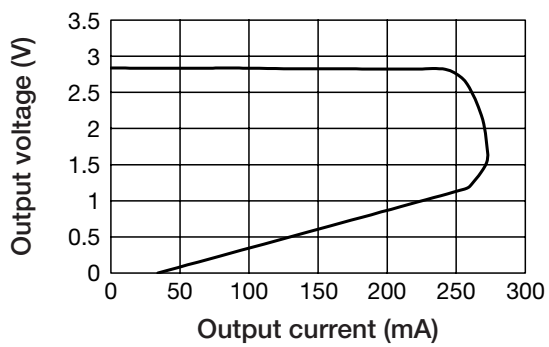

■ Current Limit Vo2

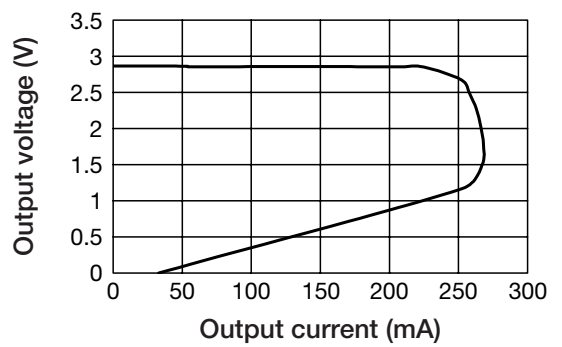

■ Input Current-Input Voltage

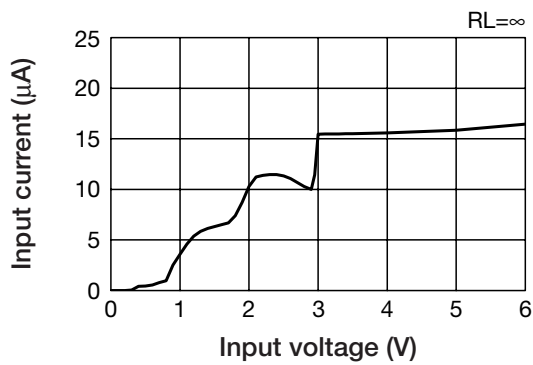

■ Load transient response V_{O1} ($I_o=10 \rightarrow 150\text{mA}$)

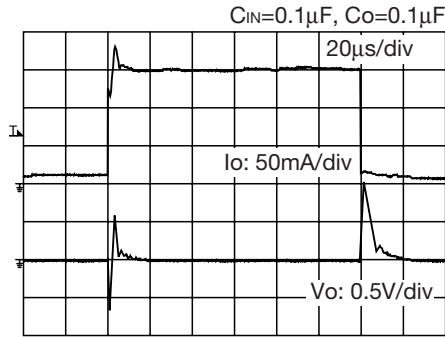

■ Load transient response V_{O2} ($I_o=10 \rightarrow 150\text{mA}$)

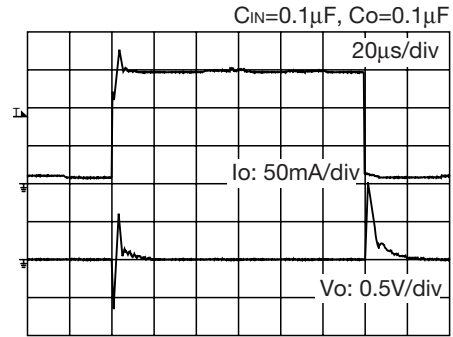

■ Load transient response V_{O1} ($I_o=10 \rightarrow 150\text{mA}$)

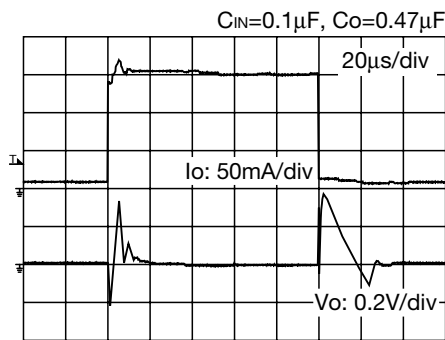

■ Load transient response V_{O2} ($I_o=10 \rightarrow 150\text{mA}$)

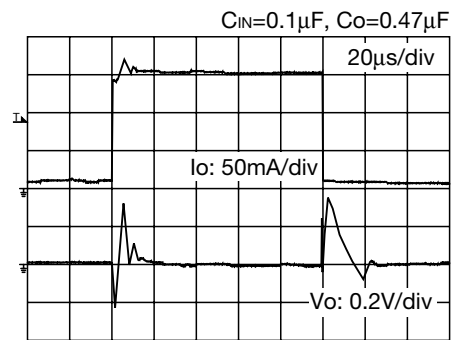

■ Load transient response V_{O1} ($I_o=10 \rightarrow 150\text{mA}$)

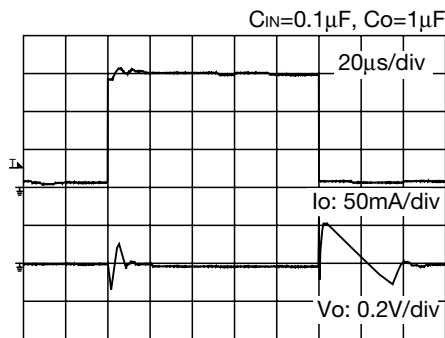

■ Load transient response V_{O2} ($I_o=10 \rightarrow 150\text{mA}$)

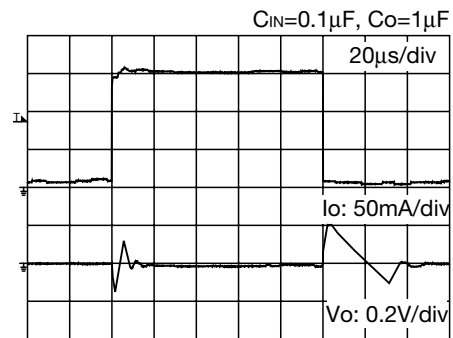

■ Load transient response V_{O1} ($I_o=50 \rightarrow 150\text{mA}$)

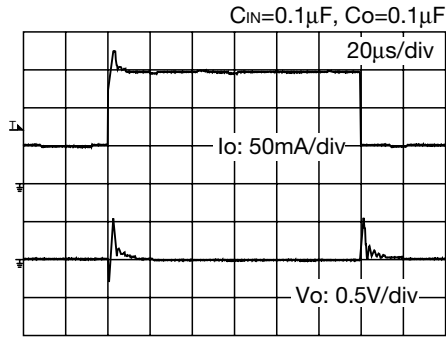

■ Load transient response V_{O2} ($I_o=50 \rightarrow 150\text{mA}$)

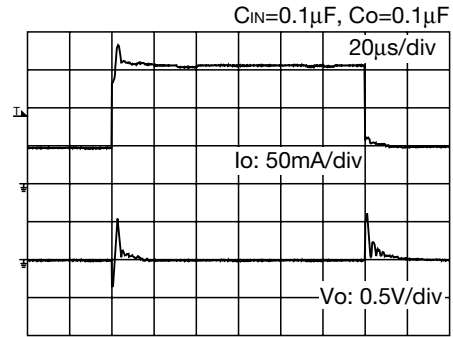

■ Load transient response V_{O1} ($I_o=50 \rightarrow 150\text{mA}$)

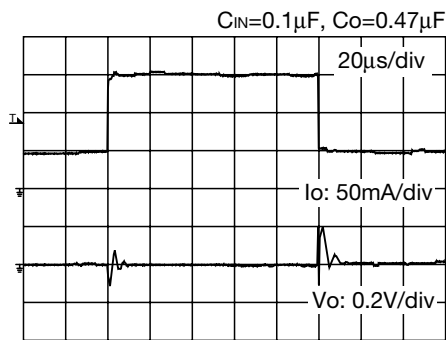

■ Load transient response V_{O2} ($I_o=50 \rightarrow 150\text{mA}$)

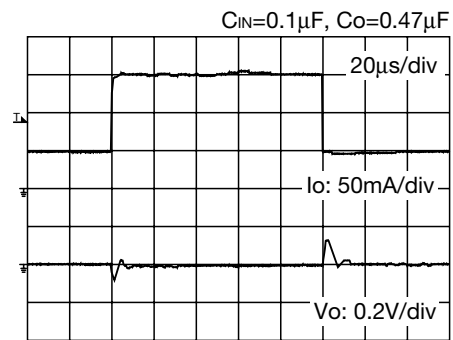

■ Load transient response V_{O1} ($I_o=50 \rightarrow 150\text{mA}$)

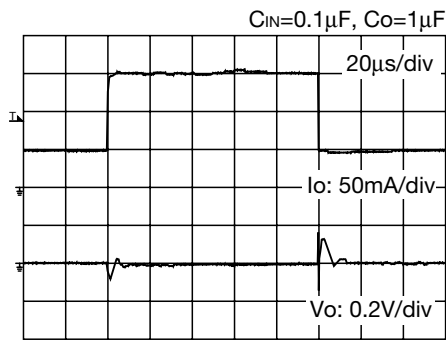

■ Load transient response V_{O2} ($I_o=50 \rightarrow 150\text{mA}$)

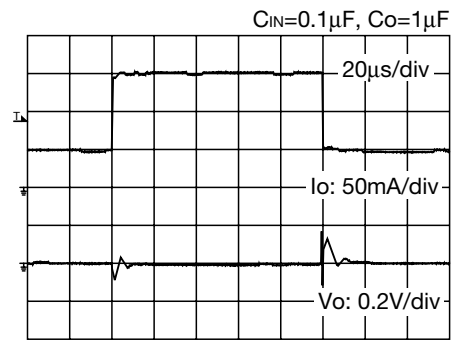

■ Ripple Rejection Vo1

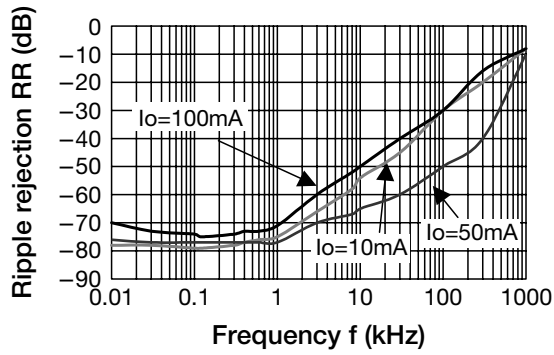

■ Ripple Rejection Vo2

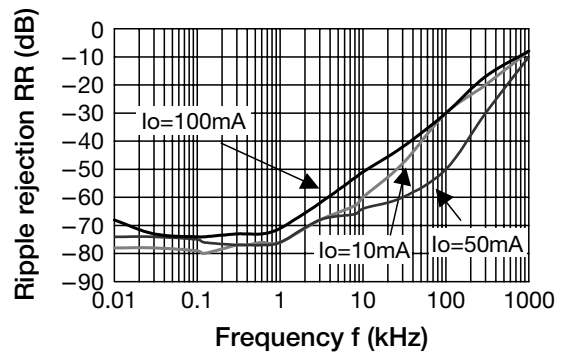

■ Output Voltage Vo1-Temperature

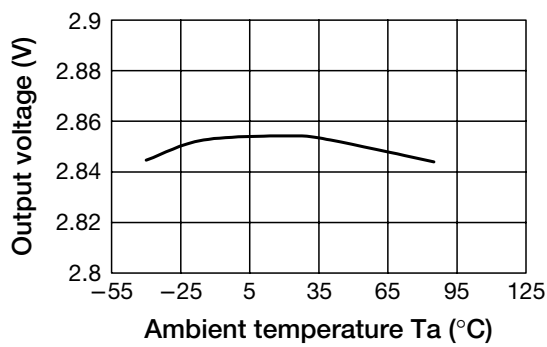

■ Output Voltage Vo2-Temperature

