

Low-Saturation 1200mA Regulators

Monolithic IC MM176□□ Series

Outline

This IC is a small stabilized power supply IC that provides output voltage accuracy of $\pm 2\%$, output current of 1200mA (max.), and dropout voltage of 0.21V typ. with 1200mA. It also provides an output noise reduction pin and output ON/OFF control pin.

Features

- | | |
|----------------------------------|------------------------------------|
| 1. Current consumption (no load) | 1mA typ. |
| 2. High accuracy output voltage | $\pm 2.0\%$ |
| 3. Dropout voltage | 0.21V typ. ($I_o=1200\text{mA}$) |
| 4. High ripple rejection | 65dB typ. |
| 5. Operating temperature range | -40 to $+85^\circ\text{C}$ |
| 6. Output voltage | 0.9 to 2.0V (0.1V steps) |
| 7. Output capacitor | 1 μF (Ceramic) |

Package

HSOP-8A

Applications

1. TVs
2. Printers
3. DVD equipment
4. Portable equipment

Pin Assignment

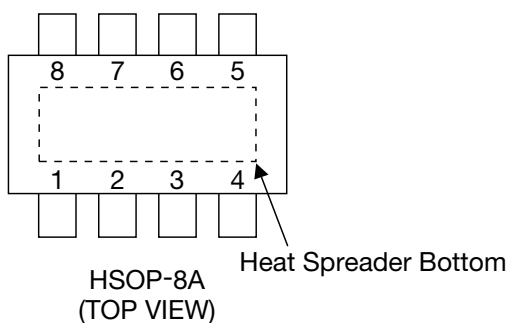

1	V_{OUT}
2	NC
3	GND
4	C_n
5	CONT
6	NC
7	NC
8	V_{IN}

R No. table

■ Taping: B housing

Parts No.	Vo (V)	R No. (R59)
MM1760KHBE	0.9	1480
MM1761AHBE	1.0	1481
MM1761BHBE	1.1	1482
MM1761CHBE	1.2	1479
MM1761DHBE	1.3	1483
MM1761EHBE	1.4	1484
MM1761FHBE	1.5	1485
MM1761GHBE	1.6	1486
MM1761HHBE	1.7	1487
MM1761JHBE	1.8	1488
MM1761KHBE	1.9	1489
MM1762AHBE	2.0	1490

Block Diagram

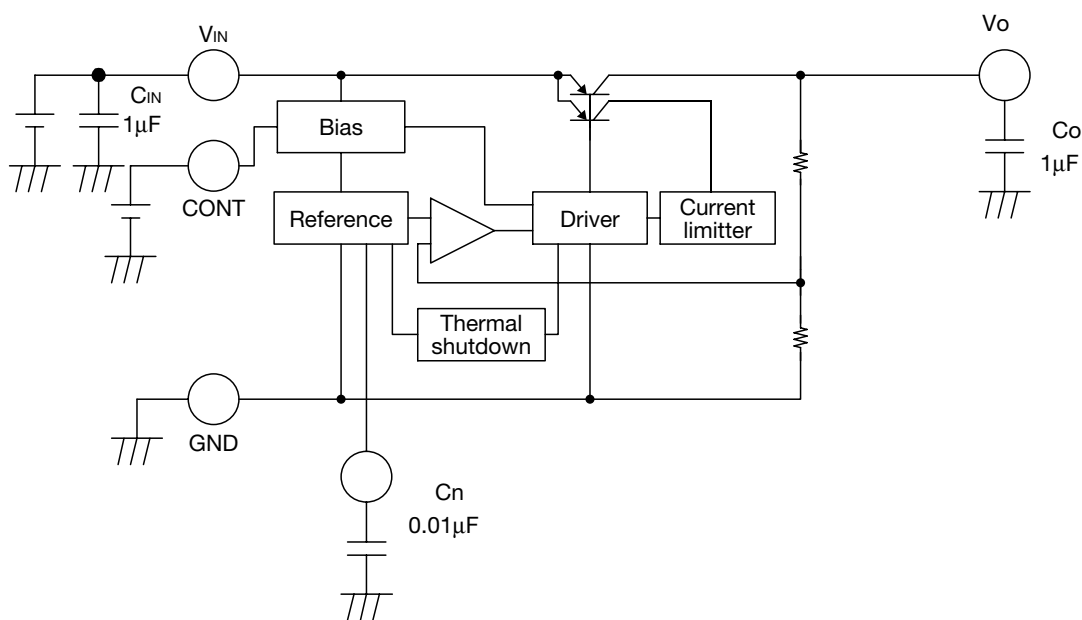

• Any products mentioned in this catalog are subject to any modification in their appearance and others for improvements without prior notification.
 • The details listed here are not a guarantee of the individual products at the time of ordering. When using the products, you will be asked to check their specifications.

Pin Description

Pin No.	Pin name	Function	Internal equivalent circuit diagram						
1	V _{OUT}	Output pin The capacitor must be connected with the output pin more than 1μF.							
2	NC	No connection							
3	GND	Ground							
4	Cn	Noise decrease pin Connecting with the 0.01μF capacitor can decrease output noise. If the capacitor is not connected, the pin may be influenced by outside noise.							
5	CONT	Control pin <table border="1"> <tr> <td>CONT</td> <td>Output</td> </tr> <tr> <td>H</td> <td>ON</td> </tr> <tr> <td>L</td> <td>OFF</td> </tr> </table>	CONT	Output	H	ON	L	OFF	
CONT	Output								
H	ON								
L	OFF								
6	NC	No connection							
7	NC	No connection							
8	V _{IN}	Input pin The capacitor is required to be connected with the input pin more than 1μF.							

Absolute Maximum Ratings (Ta=25°C)

Item	Symbol	Ratings	Units
Storage temperature	T _{STG}	-40~+150	°C
Supply voltage	V _{IN}	-0.3~+12	V
Max output current	I _{OUT max}	1.5	A
Power dissipation	P _d	1800 (*1)	mW

Note1: *1 With the double sided PC Board of glass epoxy. (37×37×1.6mm copper plane 80%)

Recommended Operating Conditions (Ta=25°C)

Item	Symbol	Ratings	Units
Operating temperature	T _{OPR}	-40~+85	°C
Output current	I _{OUT}	0~1.2	A
Operating voltage	V _{OP}	V _O (Typ.) 0.3~10 (*1)	V

Note1: *1 The Operating voltage is 0.35~10V in the model less than V_{OUT}=1V.

Electrical Characteristics 1 (Except where noted otherwise, Ta=25°C, V_{IN}=V_O+0.5V, V_{CONT}=0.8V, I_O=1mA)

Item	Symbol	Measurement conditions	Min.	Typ.	Max.	Units
No-Load input current	I _{CC}	I _O =0mA		1	2	mA
Input current (OFF)	I _{CCOFF}	V _{CONT} =0V		0	1	μA
Output voltage *2	V _{OUT}		×0.98		×1.02	V
Dropout voltage *3	V _{IO}	V _{IN} =V _{OUT} -0.1V, I _O =1.2A		0.21	0.3	V
Line regulation	ΔV ₁	V _{IN} =V _O +0.5~V _O +1.5V		10	20	mV
Load regulation *1	ΔV ₂	I _O =0~1.2A		15	40	mV
V _{OUT} temperature coefficient *1	ΔV _{OUT} /ΔT	T _J =-40~+85°C		100		ppm/°C
Ripple rejection *1	RR	f=1kHz V _{ripple} =0.5V, I _O =250mA	50	65		dB
Output noise voltage *1	V _n	f _{BW} =20~80kHz C _n =0.01μF		60		μV _{rms}
		f _{BW} =20~80kHz C _n =OPEN		150		
CONT pin input current *4	I _{CONT}			0.3	0.6	μA
CONT pin high threshold level	V _{CONTH}		0.8		10	V
CONT pin low threshold level	V _{CONTL}		-0.3		0.2	V

Note 1: *1 The parameter is guaranteed by design.

Note 2: *2 Please refer to Electrical Characteristics 2.

Note 3: *3 The parameter is not guaranteed in the model less than V_{OUT}=1V.

Note 4: *4 Please refer to 'Characteristics'.

Electrical Characteristics 2 (Except where noted otherwise, Ta=25°C, V_{IN}=V_O+0.5V, I_O=1mA)

Output Voltage

Model No.	Test conditions	Output voltage		
		Min.	Typ.	Max.
MM1760K		0.870	0.9	0.930
MM1761A		0.970	1.0	1.030
MM1761B		1.070	1.1	1.130
MM1761C		1.170	1.2	1.230
MM1761D		1.270	1.3	1.330
MM1761E		1.370	1.4	1.430
MM1761F		1.470	1.5	1.530
MM1761G		1.568	1.6	1.632
MM1761H		1.666	1.7	1.734
MM1761J		1.764	1.8	1.836
MM1761K		1.862	1.9	1.938
MM1762A		1.960	2.0	2.040

Measuring Circuit

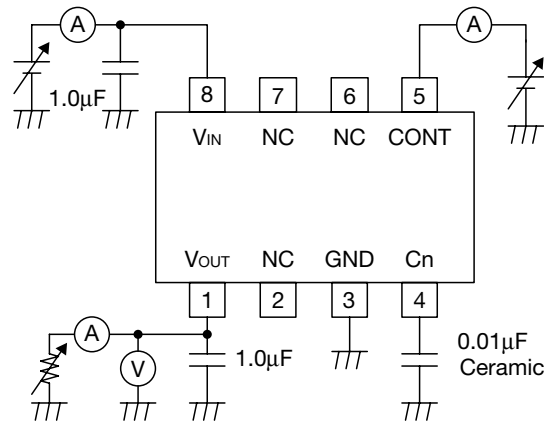

Application Circuit

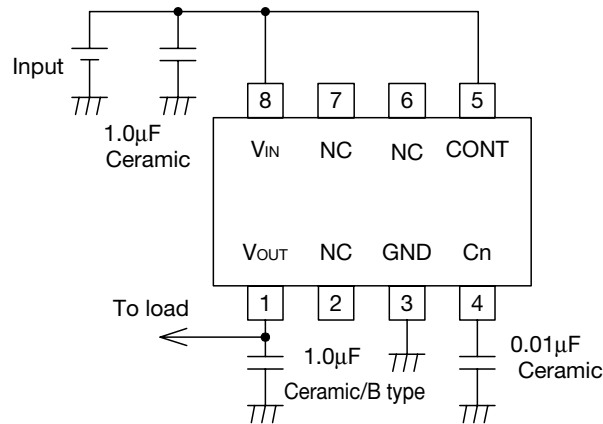

C _{IN}		C _{OUT}		Characteristics
Capacity	Kind	Capacity	Kind	
2.2µF or more	Ceramic	10µF	Ceramic	B type/X5R
1.0µF	Ceramic	1.0µF	Ceramic	B type/X5R

Note

1. The output capacitor is required between output and GND to prevent oscillation.
2. The output capacitor must be used in ESR stable area.
3. The wire of V_{CC} and GND is required to print full ground plane for noise and stability.
4. The input capacitor must be connected in 1cm from input pin.
5. The capacitor connected to C_n must have low leakage current characteristics, because C_n pin is high impedance.
6. In case the output voltage is above the input voltage, the overcurrent flows by internal parasitic diode from output to input. In such application, the external bypass diode must be connected between the output pin and the input pin.

Power Dissipation

This IC's GND pin and the Heat Spreader Bottom effectively radiate heat. By increasing these copper foil pattern area of PCB, power dissipation improves. Please kindly design PCB pattern taking care of above features about the power dissipation.

Power Dissipation

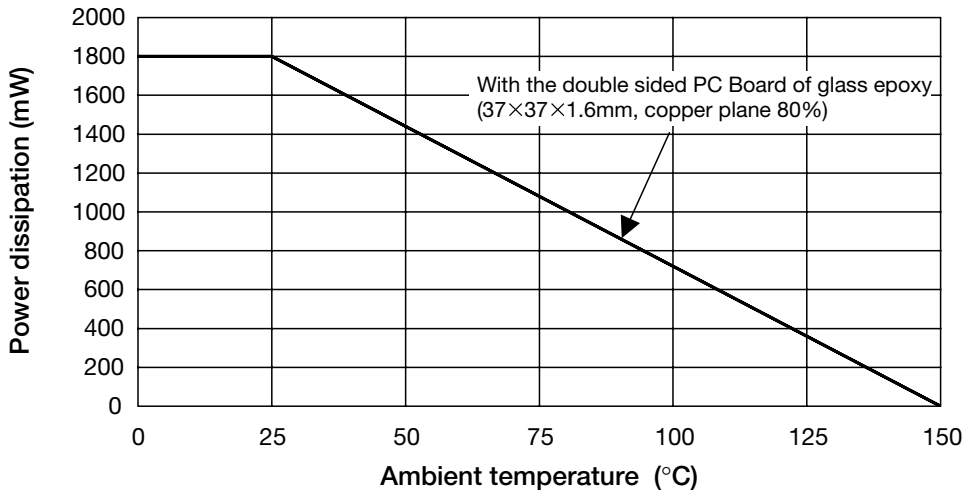

Land Pattern Recommendation

HSOP-8

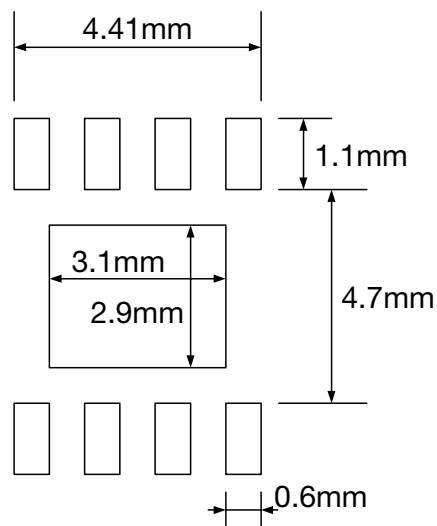

Note: These Dimensions are the reference values.

Characteristics ($V_o=1.2V$ Except where noted otherwise, $T_a=25^\circ C$, $V_{IN}=V_o+0.5V$, $V_{CONT}=0.8V$, $C_{IN}=1.0\mu F$, $C_o=1.0\mu F$)

Input Voltage-Output Voltage

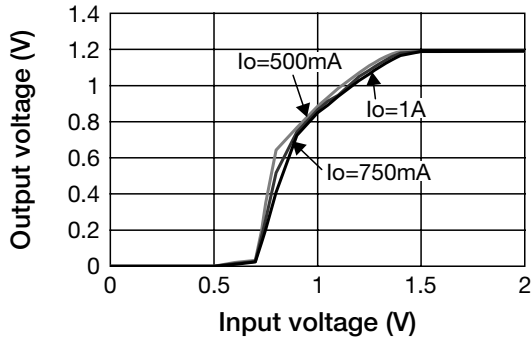

No Load Input Current

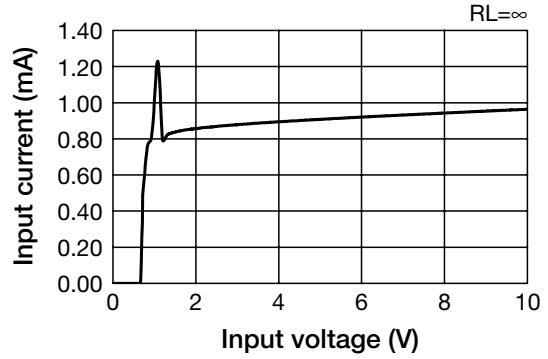

Load Regulation

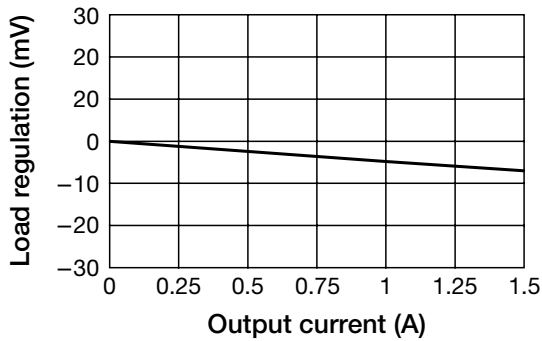

Line Regulation

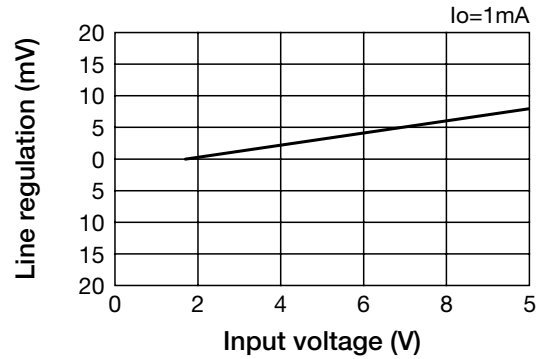

Drop Voltage

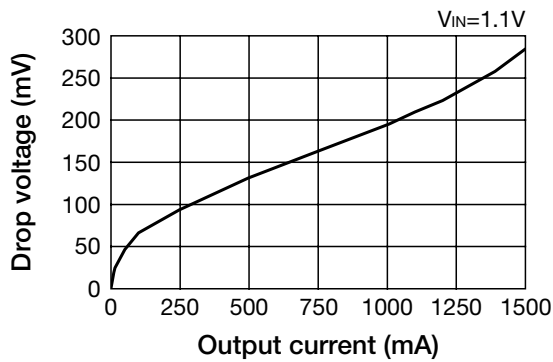

Temperature-Drop Voltage

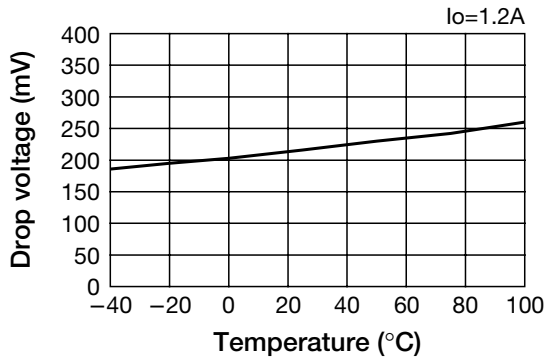

• Any products mentioned in this catalog are subject to any modification in their appearance and others for improvements without prior notification.
 • The details listed here are not a guarantee of the individual products at the time of ordering. When using the products, you will be asked to check their specifications.

Characteristics ($V_o=1.2V$ Except where noted otherwise, $T_a=25^\circ C$, $V_{IN}=V_o+0.5V$, $V_{CONT}=0.8V$, $C_{IN}=1.0\mu F$, $C_o=1.0\mu F$)

Ripple Rejection

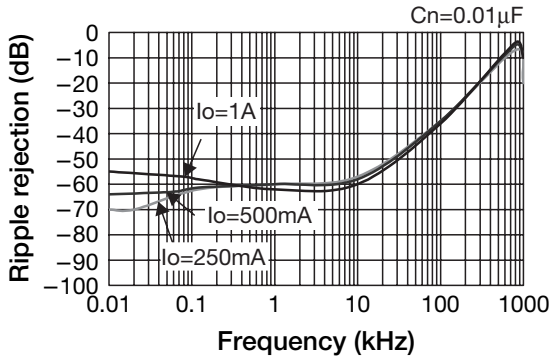

ESR Stable Area

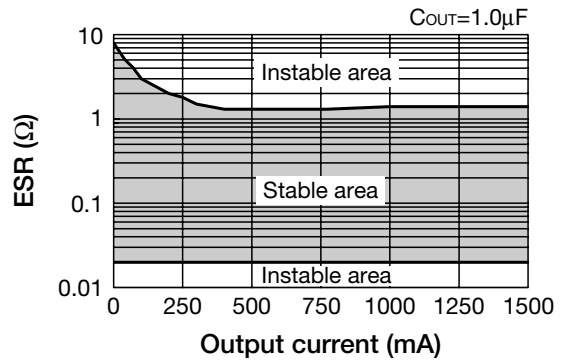

GND Pin Current

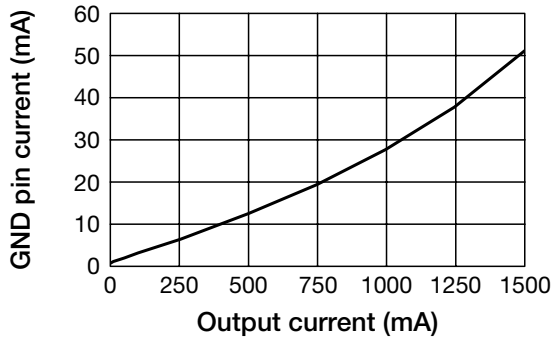

Output Voltage-Temperature

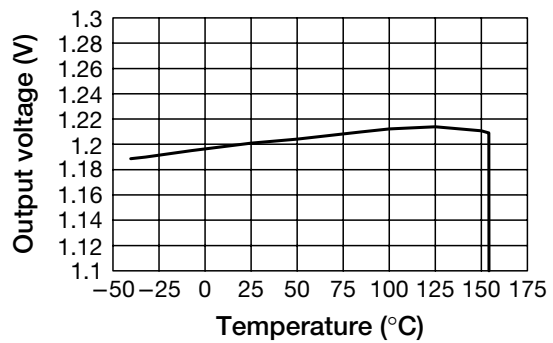

CONT Pin Input Current

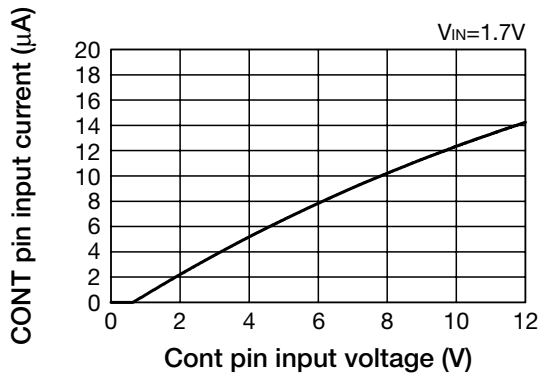

Current Limit

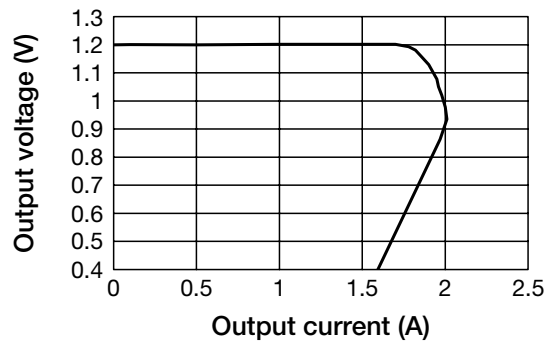

Characteristics ($V_o=0.9V$ Except where noted otherwise, $T_a=25^\circ C$, $V_{IN}=V_o+0.5V$, $V_{CONT}=0.8V$, $C_{IN}=1.0\mu F$, $C_o=1.0\mu F$)

Input Voltage-Output Voltage

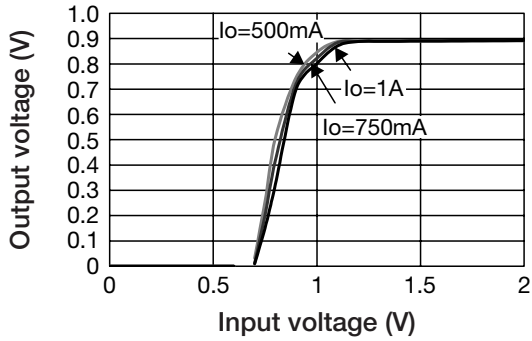

No Load Input Current

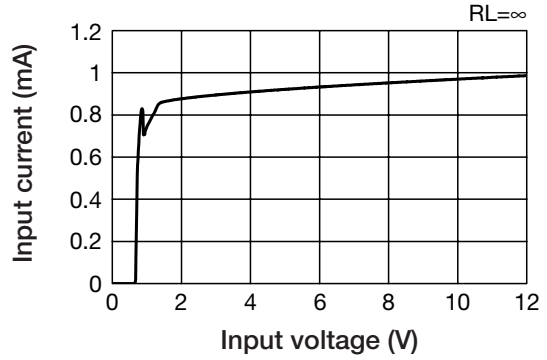

Load Regulation

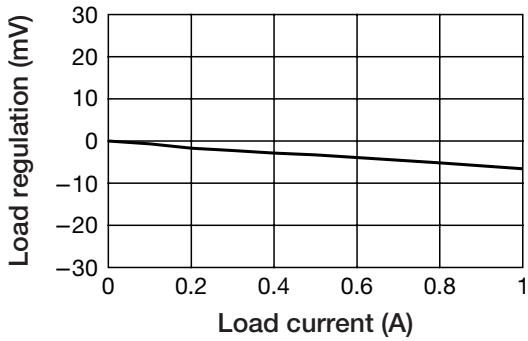

Line Regulation

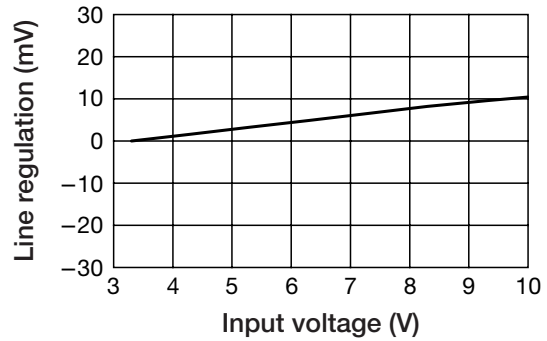

Drop Voltage

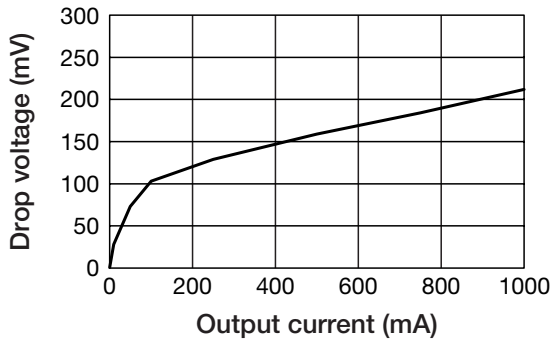

Temperature-Output Voltage

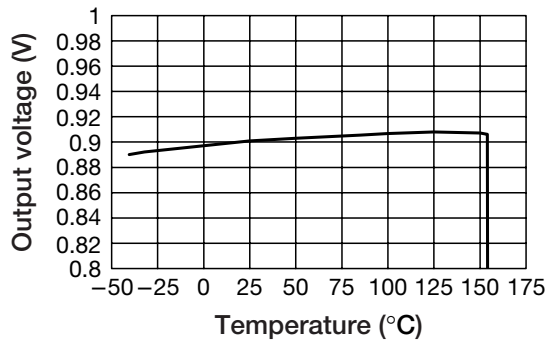

• Any products mentioned in this catalog are subject to any modification in their appearance and others for improvements without prior notification.
 • The details listed here are not a guarantee of the individual products at the time of ordering. When using the products, you will be asked to check their specifications.

Characteristics ($V_o=1.8V$ Except where noted otherwise, $T_a=25^\circ C$, $V_{IN}=V_o+0.5V$, $V_{CONT}=0.8V$, $C_{IN}=1.0\mu F$, $C_o=1.0\mu F$)

Input Voltage-Output Voltage

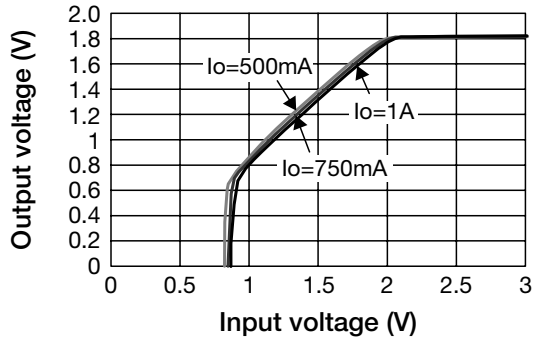

No Load Input Current

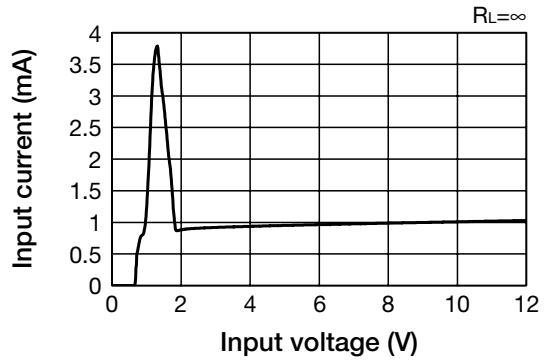

Load Regulation

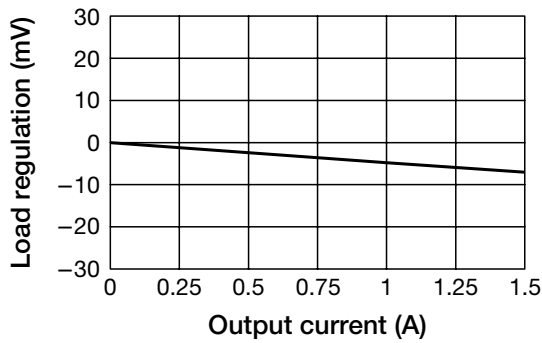

Line Regulation

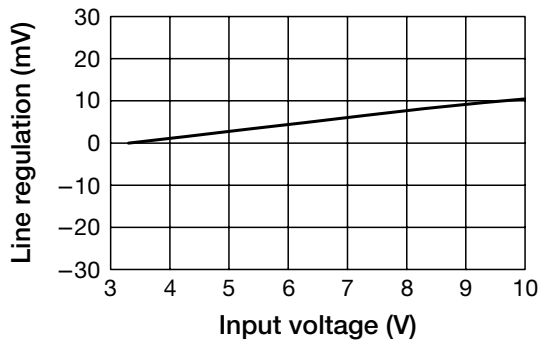

Drop Voltage

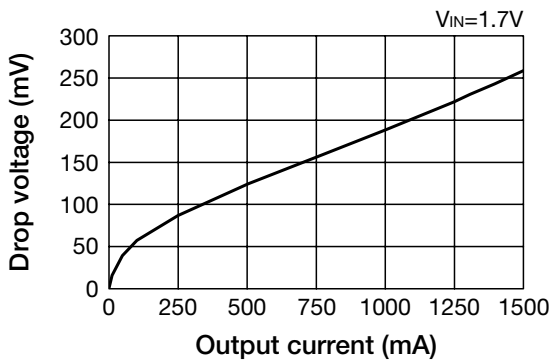

Temperature-Output Voltage

