

1000mA Regulator IC Monolithic IC MM342XX

Outline

This IC is a series regulator that has been developed to be the best choice for stationary as well as mobile equipment in which power consumption shall be reduced when the power is off or the equipment is in its standby mode.

The regulator can output the maximum current of 1000mA.

This IC has a chip enable function and the model implemented in the smaller SSON-6 package is also available for the high-density packaging.

Features

- | | |
|--|--|
| 1. Consumption current under no load condition | 45 μ A typ. |
| 2. Consumption current when power is off | 0.1 μ A typ |
| 3. High ripple rejection | 70dB / 1kHz |
| 4. Output capacitor | Compatible with 1 μ F ceramic capacitor |
| 5. Protection circuit | Current limit circuit and Thermal shutdown circuit |

Package

SSON-6
HSOP-8A
SOT-25A

Applications

1. TVs
2. Portable equipments
3. DVD, Blu-ray recorders

Block Diagram

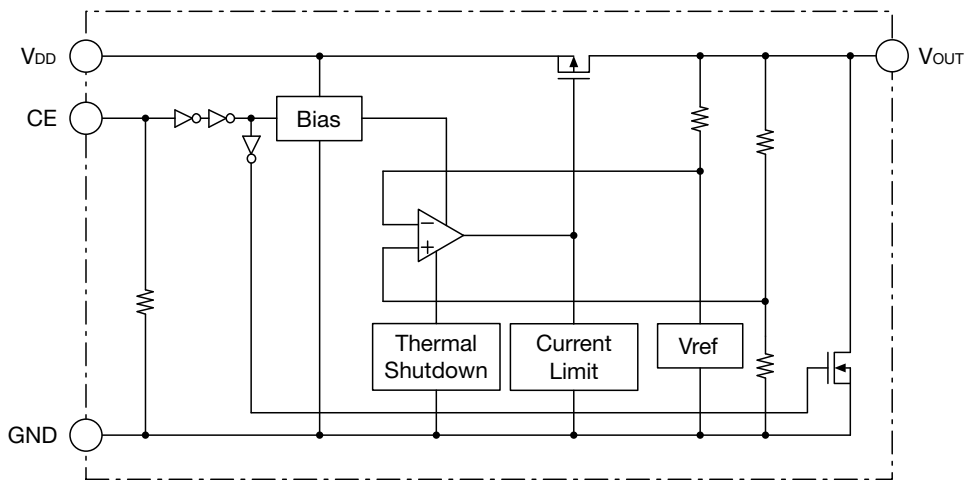

Pin Assignment

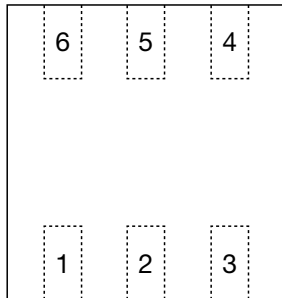

HSOP-8A
(TOP VIEW)

1	V _{DD}
2	NC
3	V _{OUT}
4	NC
5	GND
6	CE

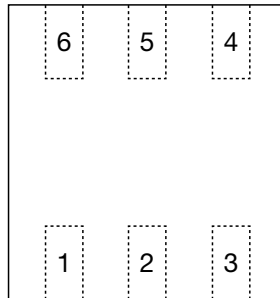

SSON-6
(TOP VIEW)

1	V _{DD}
2	NC
3	V _{OUT}
4	NC
5	GND
6	CE

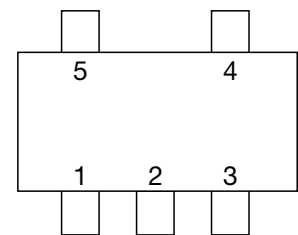

SOT-25A
(TOP VIEW)

1	V _{DD}
2	GND
3	CE
4	NC
5	V _{OUT}

Pin Description

HSOP-8A

Pin No.	Pin name	Functions						
1	V _{DD}	Voltage-supply pin						
2,4	NC	No connection						
3	V _{OUT}	Outout pin						
5	GND	Ground pin						
6	CE	ON/OFF-Control pin						
		<table border="1"> <thead> <tr> <th>CE</th> <th>OUTPUT</th> </tr> </thead> <tbody> <tr> <td>Low</td> <td>OFF</td> </tr> <tr> <td>High</td> <td>ON</td> </tr> </tbody> </table>	CE	OUTPUT	Low	OFF	High	ON
		CE	OUTPUT					
		Low	OFF					
High	ON							
Connect CE pin with V _{DD} pin, when it is not used.								

SSON-6

Pin No.	Pin name	Functions						
1	V _{DD}	Voltage-supply pin						
2,4	NC	No connection						
3	V _{OUT}	Outout pin						
5	GND	Ground pin						
6	CE	ON/OFF-Control pin						
		<table border="1"> <thead> <tr> <th>CE</th> <th>OUTPUT</th> </tr> </thead> <tbody> <tr> <td>Low</td> <td>OFF</td> </tr> <tr> <td>High</td> <td>ON</td> </tr> </tbody> </table>	CE	OUTPUT	Low	OFF	High	ON
		CE	OUTPUT					
		Low	OFF					
High	ON							
Connect CE pin with V _{DD} pin, when it is not used.								

SOT-25A

Pin No.	Pin name	Functions						
1	V _{DD}	Voltage-supply pin						
2	GND	Ground pin						
3	CE	ON/OFF-Control pin						
		<table border="1"> <thead> <tr> <th>CE</th> <th>OUTPUT</th> </tr> </thead> <tbody> <tr> <td>Low</td> <td>OFF</td> </tr> <tr> <td>High</td> <td>ON</td> </tr> </tbody> </table>	CE	OUTPUT	Low	OFF	High	ON
		CE	OUTPUT					
		Low	OFF					
High	ON							
Connect CE pin with V _{DD} pin, when it is not used.								

4	NC	No connection
5	V _{OUT}	Outout pin

Absolute Maximum Ratings (Except where noted otherwise Ta=25°C)

Item	Symbol	Ratings	Units
Storage temperature	T _{STG}	-55~+150	°C
Supply voltage	V _{DD}	6.5	V
CE input voltage	V _{CE}	-0.3~V _{DD} +0.3	V
Output voltage	V _{OUT}	-0.3~V _{DD} +0.3	V
Output current	I _{omax}	1200mA	mA
Power dissipation	Pd	1300(Note1)	(HSOP-8A)
		180(Note1)	(SSON-6A)
		350(Note1)	(SOT-25A)

Note1 : With the double sided PC Board of glass epoxy
(Copper plane 80%, 25 × 25 × 1.6[±]mm)

Recommended Operating Conditions (Except where noted otherwise Ta=25°C)

Item	Symbol	Ratings	Units
Operating ambient temperature	T _{JOP}	-40~85	°C
Operating voltage	V _{OP}	2~6	V
Output current	I _O	0~1000	mA

Electrical Characteristics 1 (Except where noted otherwise V_{DD}=V_{OUT}(typ.)+1V, V_{CE}=V_{DD}, Ta=25°C)

Item	Symbol	Measurement conditions	Min.	Typ.	Max.	Units
Input current(OFF)	I _{DDoff}	V _{CE} =0V		0.1	1.0	μA
No-Load input current	I _{DD}	I _{OUT} =0mA		40	70	μA
Output voltage	V _{OUT}	I _{OUT} =30mA	×0.98		×1.02	V
Line regulation	V _{LINE}	V _{DD} =V _O (typ.)+0.5~6V, I _{OUT} =30mA (V _{OUT} ≤1.6V, V _{DD} =2.2~6V)		0.02	0.10	%/V
Load regulation	V _{LOAD}	1mA≤I _{OUT} ≤1000mA		50	180	mV
Dropout voltage	V _{IO}	Please refer to another page				V
Ripple rejection 1 (Note2)	RR1	f=1kHz, V _{ripple} =0.5V, I _{OUT} =30mA (V _{OUT} ≤1.7V, V _{DD} =V _{OUT} +1.2V)		70		dB
Ripple rejection 2 (Note2)	RR2	f=10kHz, V _{ripple} =0.5V, I _{OUT} =30mA (V _{OUT} ≤1.7V, V _{DD} =V _{OUT} +1.2V)		50		dB
V _{OUT} temperature coefficient (Note2)	ΔV _{OUT} /ΔT	I _{OUT} =30mA -40°C≤T _{OP} ≤85°C		±100		ppm/°C
Output noise voltage (Note2)	V _n	f _{BW} =10~100kHz I _{OUT} =30mA		30		μV _{rms}
Output short-circuit current (Note2)	I _{lim}	V _{OUT} =0V		40		mA
CE Pull-down resistance	R _{pd}		0.7	2	8	MΩ
CE H threshold voltage	V _{CEH}		1.5		V _{DD}	V
CE L threshold voltage	V _{CEL}		0		0.3	V
Output NMOS ON resistance	R _{DON}	V _{CE} =0V V _{DD} =4V(V _{OUT} <3V)		30		Ω

Note2 : The parameter is guaranteed by design.

Electrical Characteristics 2 (Except where noted otherwise $V_{DD}=V_o(\text{typ.})+1V$, $V_{CE}=V_{DD}$, $T_a=25^\circ\text{C}$)

Output voltage Vo1, Vo2	Item							
	Output voltage				Dropout voltage			
	Vo1, Vo2 (V)				Vio1, Vio2 (V)			
	Measurement conditions	Min.	Typ.	Max.	Measurement conditions	Min.	Typ.	Max.
1.5V		1.470	1.500	1.530	(Note3)			
1.6V		1.568	1.600	1.632				
1.7V		1.666	1.700	1.734				
1.8V		1.764	1.800	1.836				
1.9V		1.862	1.900	1.938				
2.0V		1.960	2.000	2.040				
2.1V		2.058	2.100	2.142	$2.1V \leq V_o \leq 2.7V$ $I_o=1000mA$			
2.2V		2.156	2.200	2.244				
2.3V		2.254	2.300	2.346			0.55	1.00
2.4V		2.352	2.400	2.448				
2.5V		2.450	2.500	2.550				
2.6V		2.548	2.600	2.652				
2.7V		2.646	2.700	2.754				
2.8V		2.744	2.800	2.856				
2.9V		2.842	2.900	2.958				
3.0V		2.940	3.000	3.060				
3.1V		3.038	3.100	3.162	$2.5V \leq V_o \leq 5.0V$			
3.2V		3.136	3.200	3.264				
3.3V		3.234	3.300	3.366				
3.4V		3.332	3.400	3.468				
3.5V		3.430	3.500	3.570				
3.6V		3.528	3.600	3.672				
3.7V		3.626	3.700	3.774				
3.8V		3.724	3.800	3.876				
3.9V		3.822	3.900	3.978				
4.0V		3.920	4.000	4.080			0.46	0.90
4.1V		4.018	4.100	4.182				
4.2V		4.116	4.200	4.284				
4.3V		4.214	4.300	4.386				
4.4V		4.312	4.400	4.488				
4.5V		4.410	4.500	4.590				
4.6V		4.508	4.600	4.692				
4.7V		4.606	4.700	4.794				
4.8V		4.704	4.800	4.896				
4.9V		4.802	4.900	4.998				
5.0V		4.900	5.000	5.100				

Note3 : The parameter is not guaranteed in the model less than $V_o=2.0V$.

Measuring Circuit

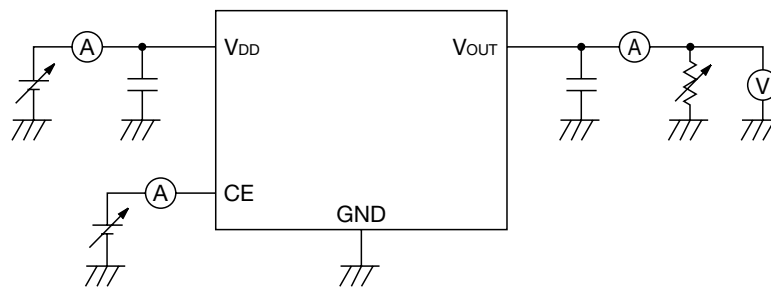

Application Circuit

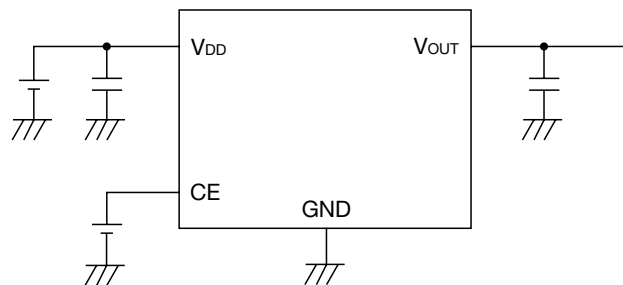

(Reference example of external parts)

- Output capacitor Ceramic capacitor 1.0 μ F
- Input capacitor Ceramic capacitor 1.0 μ F

★ Temperature Characteristics : B

· Note

1. The output capacitor is required between output and GND to prevent oscillation.
2. The ESR of capacitor must be defined in ESR stability area.
It is possible to use a ceramic capacitor without ESR resistance for output.
The ceramic capacitor must be used more than 1.0 μ F and B temperature characteristics.
3. The wire of Vcc and GND is required to print full ground plane for noise and stability.
4. The input capacitor must be connected a distance of less than 1cm from input pin.
5. In case the output voltage is above the input voltage, the overcurrent flow by internal parastic diode from output to input.

About Power dissipation

This IC's GND pin and Heat Spreader Bottom effectively radiate heat. By increasing these copper foil pattern area of PCB, Power dissipation improves. Please kindly design PCB pattern taking care of above features about power dissipation.

Power Dissipation

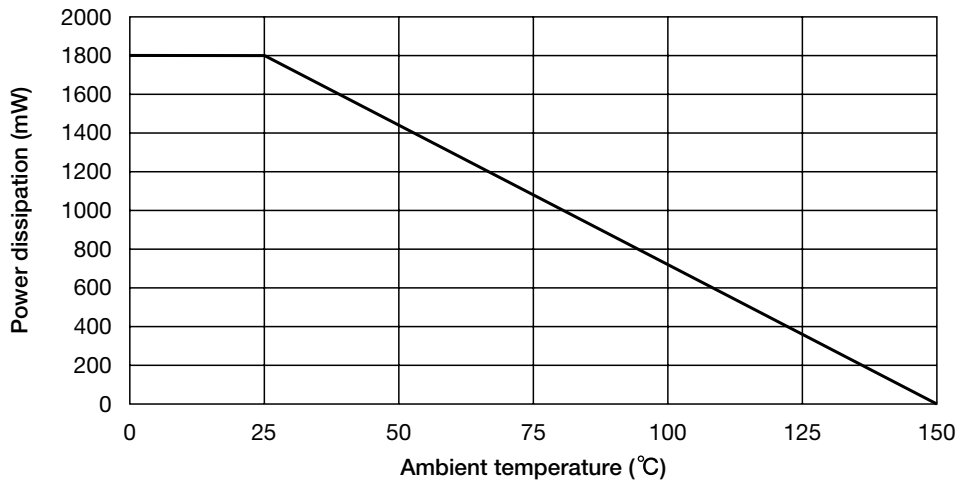

Land Pattern Recommendation

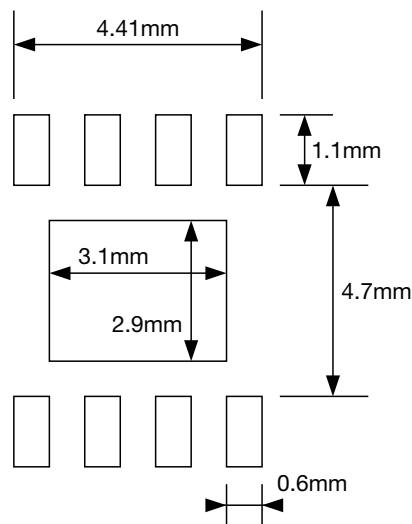

Characteristics (Vo=1.5V) (Except where noted otherwise $V_{DD}=V_{OUT}(\text{typ.}) + 1V$, $V_{CE}=V_{DD}$, $T_a=25^\circ\text{C}$)

Output - Input voltage

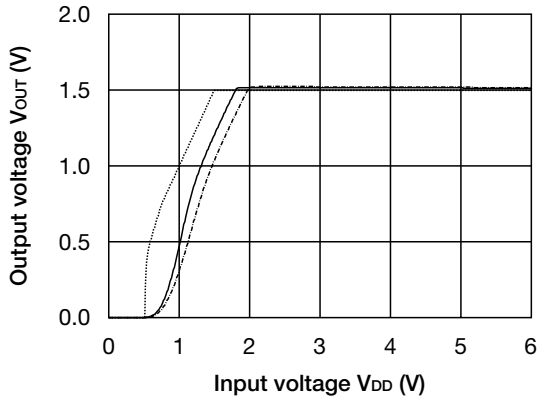

Input current - Input voltage

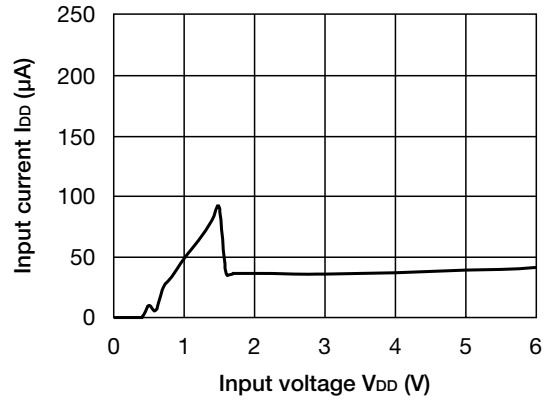

Output voltage - Output current

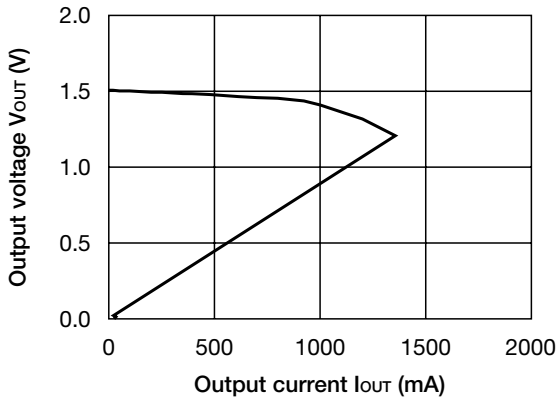

Load regulation

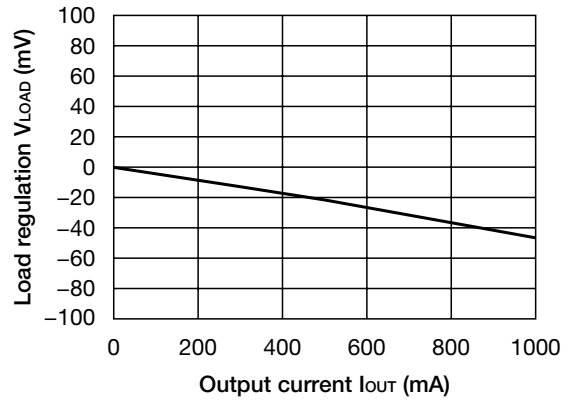

Line regulation

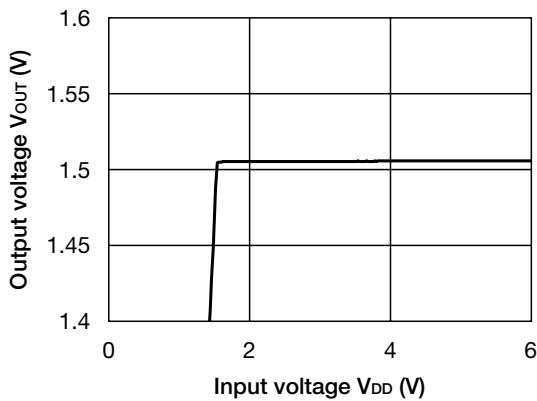

Output voltage - Ambient temperature

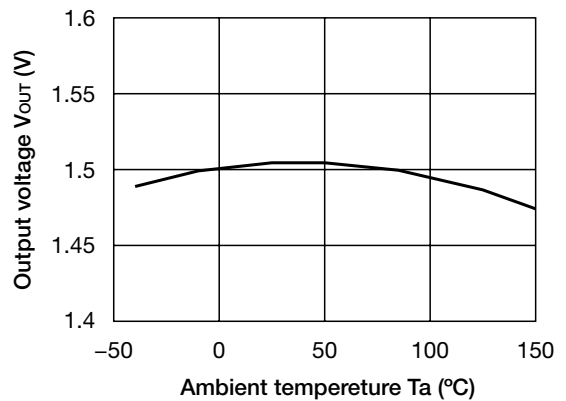

• Any products mentioned in this catalog are subject to any modification in their appearance and others for improvements without prior notification.
 • The details listed here are not a guarantee of the individual products at the time of ordering. When using the products, you will be asked to check their specifications.

Ripple Rejection

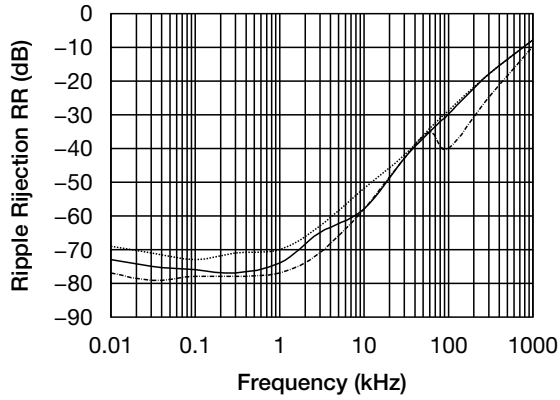

ESR stability area

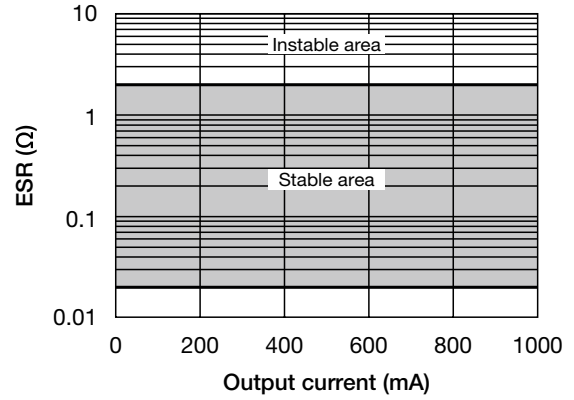

Load transient response (Io=10→500mA)

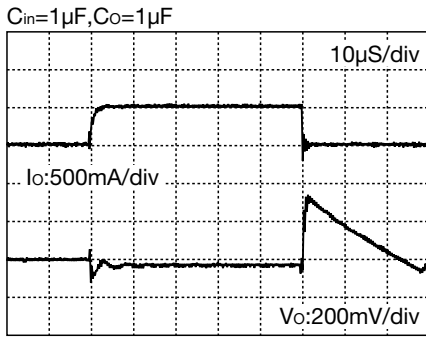

Load transient response (Io=10→1000mA)

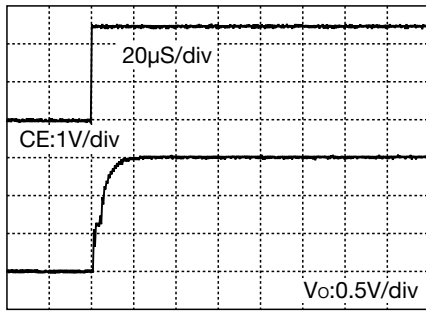
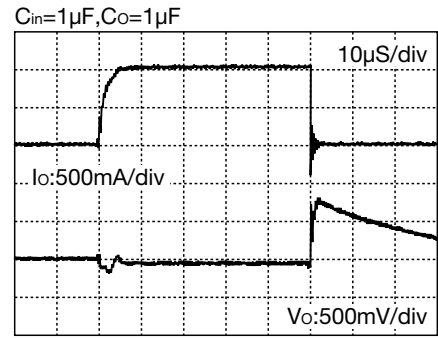

Characteristics (Vo=3.0V) (Except where noted otherwise $V_{DD}=V_{OUT}(\text{typ.}) + 1V$, $V_{CE}=V_{DD}$, $T_a=25^\circ\text{C}$)

Output - Input voltage

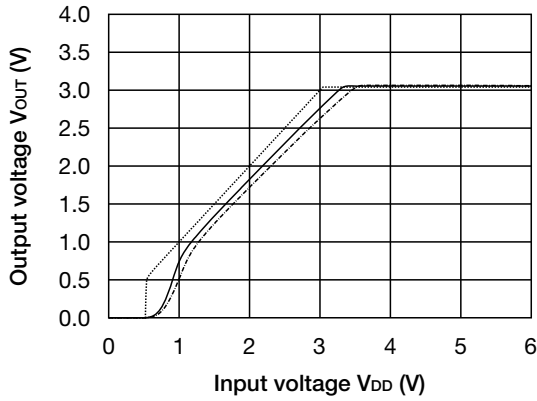

Input current - Input voltage

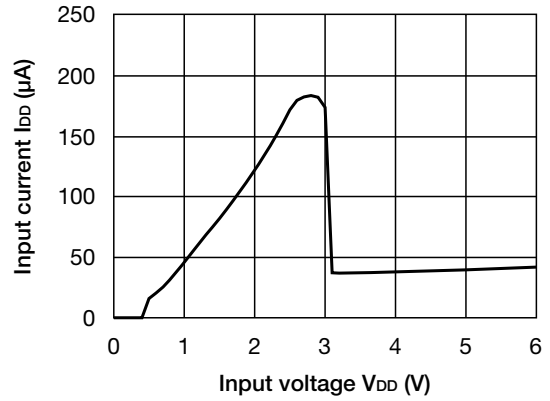

Output voltage - Output current

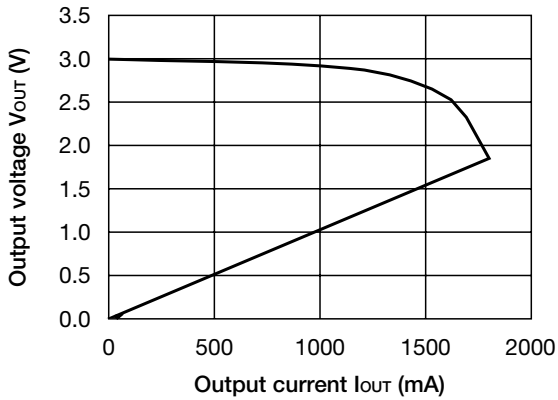

Load regulation

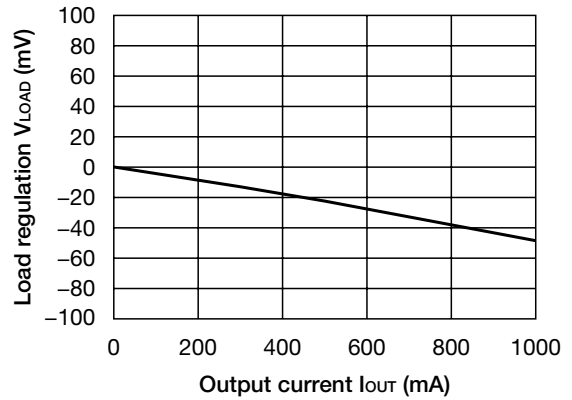

Line regulation

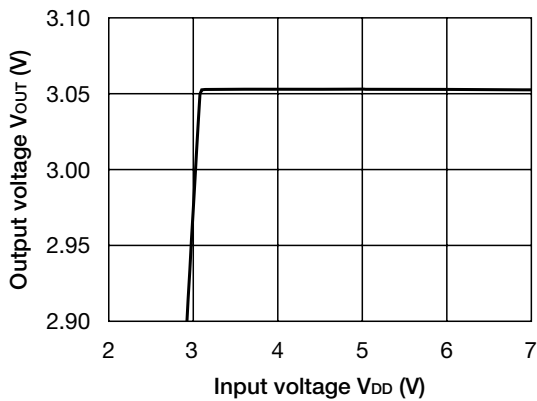

Dropout voltage

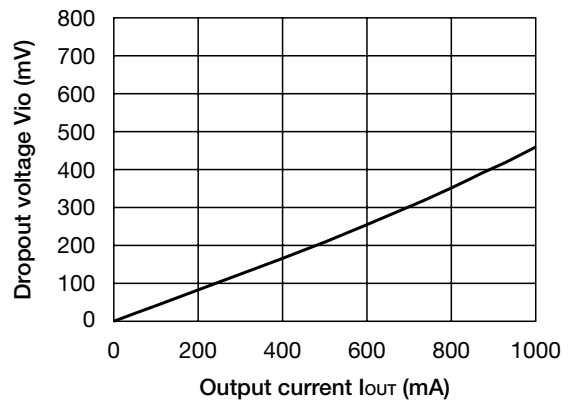

• Any products mentioned in this catalog are subject to any modification in their appearance and others for improvements without prior notification.
 • The details listed here are not a guarantee of the individual products at the time of ordering. When using the products, you will be asked to check their specifications.

Ripple Rejection

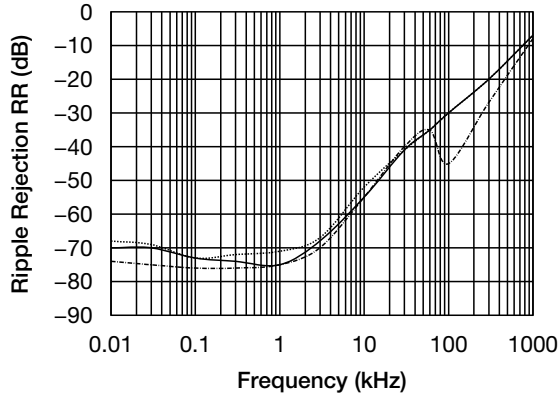

Output voltage - Ambient temperature

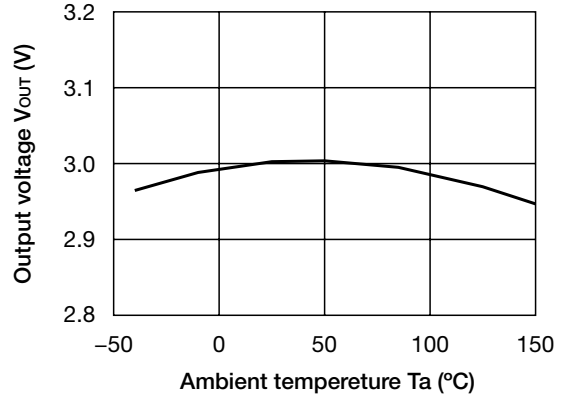

Load transient response (Io=10→500mA)

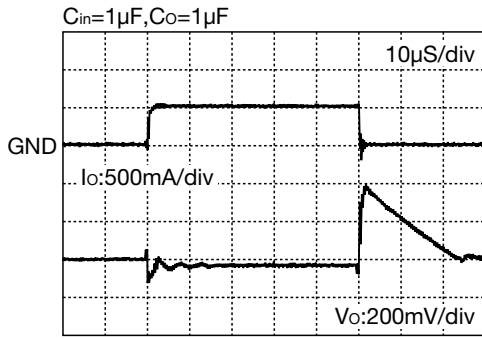

Load transient response (Io=10→1000mA)

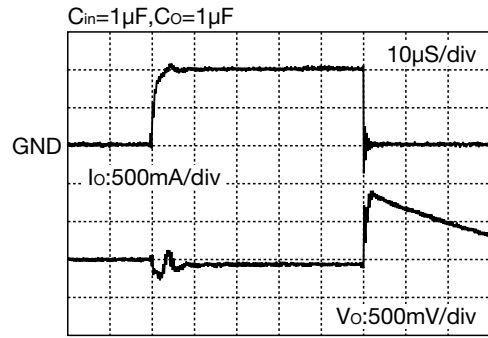

ESR stability area

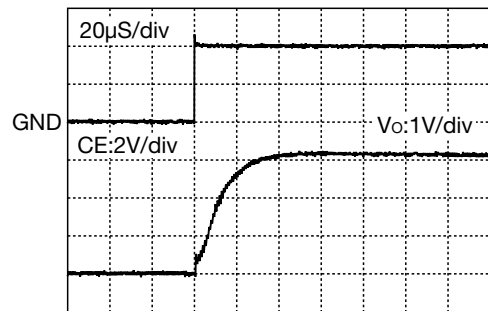
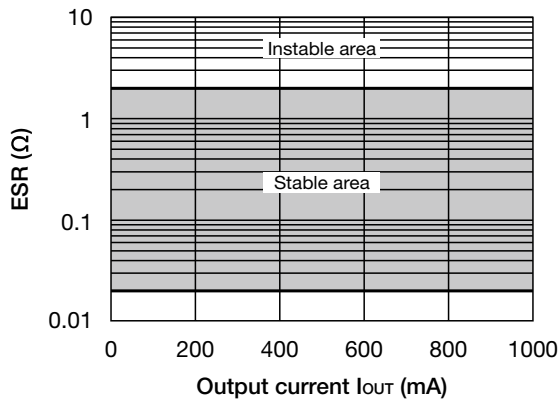

Characteristics (Vo=5.0V) (Except where noted otherwise $V_{DD}=V_{OUT}(\text{typ.}) + 1V$, $V_{CE}=V_{DD}$, $T_a=25^\circ\text{C}$)

Output - Input voltage

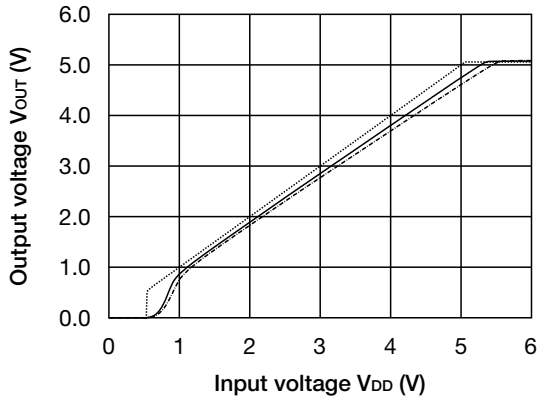

Input current - Input voltage

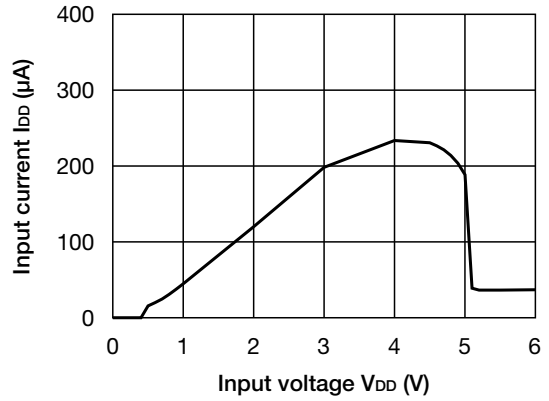

Output voltage - Output current

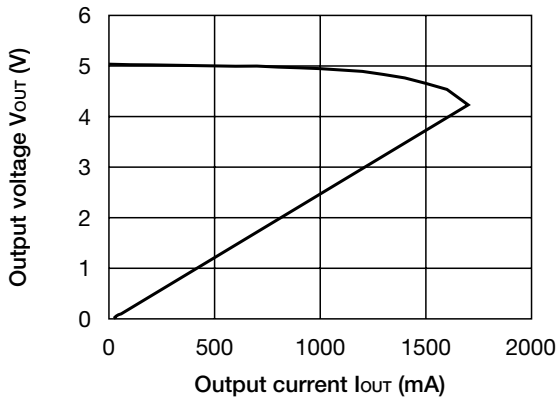

Load regulation

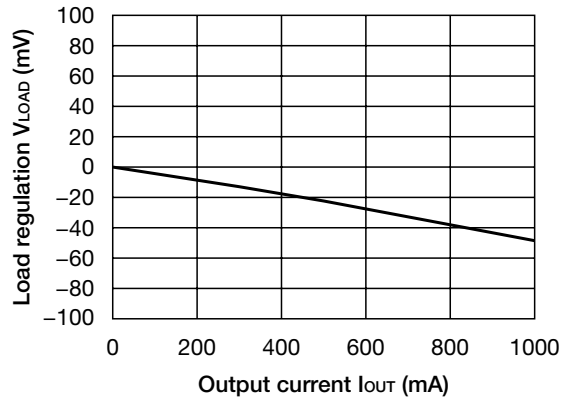

Line regulation

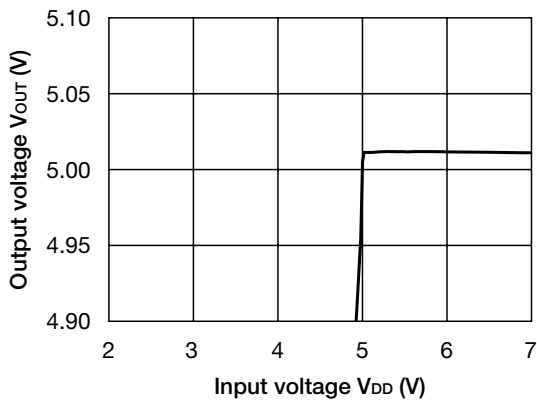

Dropout voltage

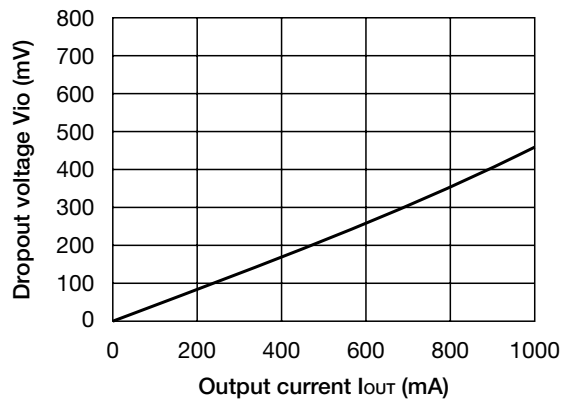

• Any products mentioned in this catalog are subject to any modification in their appearance and others for improvements without prior notification.
 • The details listed here are not a guarantee of the individual products at the time of ordering. When using the products, you will be asked to check their specifications.

Ripple Rejection

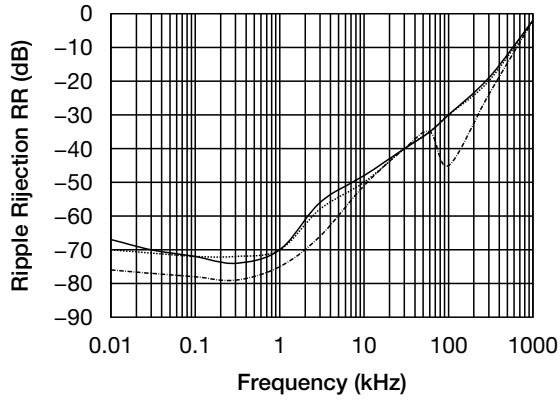

Output voltage - Ambient temperature

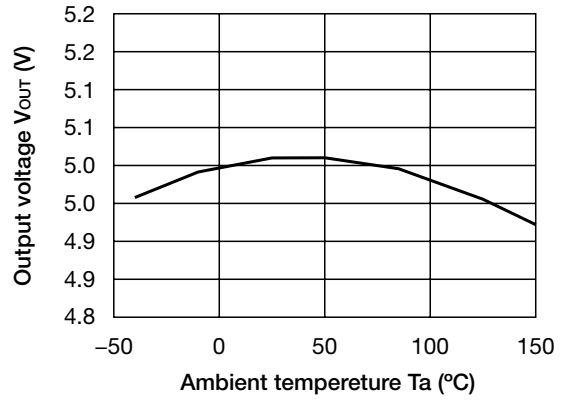

Load transient response (Io=10→500mA)

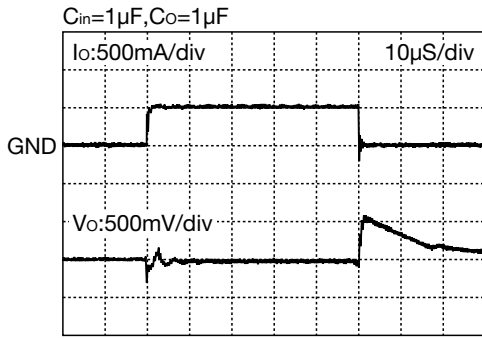

Load transient response (Io=10→1000mA)

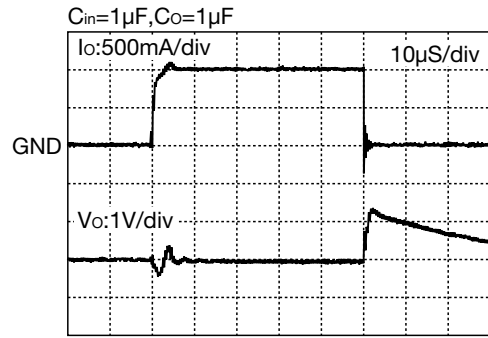

ESR stability area

