

# 500mA Regulator IC Monolithic IC MM344XX

## Outline

This IC is the series regulator that has been developed to be the best choice for stationary as well as mobile equipment in which power consumption shall be reduced when the power is off or the equipment is in its standby mode. The regulator can output the maximum current of 500mA.

This product has a chip enable function to allow further reduction of consumption current.

## Features

- |  |  |
|--|--|
| 1. Consumption current under no load condition : | 45 $\mu$ A typ.                                    |
| 2. Consumption current when power is off :       | 0.1 $\mu$ A typ.                                   |
| 3. High ripple rejection :                       | 70dB / 1kHz  |
| 4. Output capacitor :                            | Compatible with 1 $\mu$ F ceramic capacitor        |
| 5. Protection circuit :                          | Current limit circuit and thermal shutdown circuit |

## Package

SOP-7

## Applications

1. Portable equipments
2. Electric products for home use

## Block Diagram

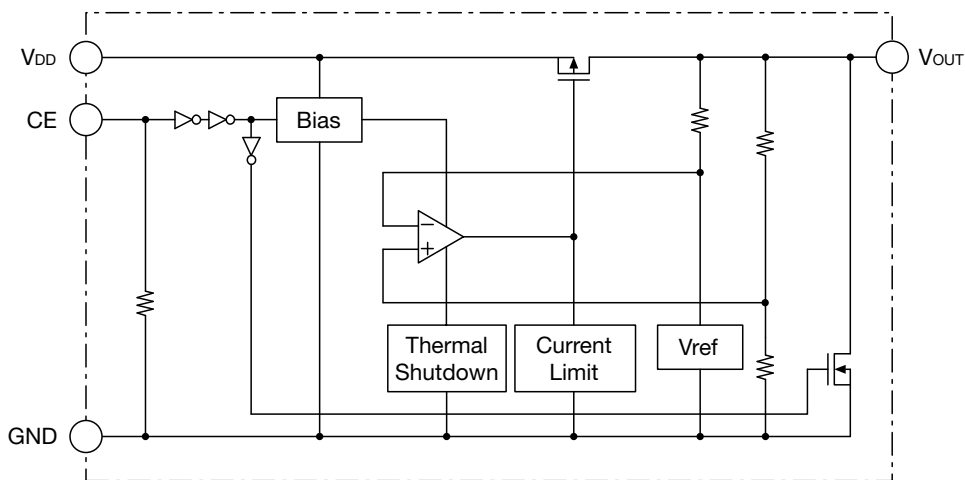

## Pin Assignment

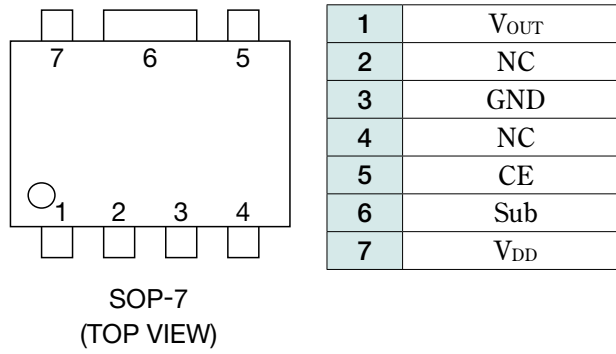

## Pin Description

Pin No.	Pin name	Functions						
1	$V_{OUT}$	Outout pin						
2, 4	NC	No connection						
3	GND	Ground Pin						
5	CE	ON/OFF-Control pin						
		<table border="1"> <tr> <td>CE</td> <td><math>V_{OUT}</math></td> </tr> <tr> <td>Low</td> <td>OFF</td> </tr> <tr> <td>High</td> <td>ON</td> </tr> </table>	CE	$V_{OUT}$	Low	OFF	High	ON
		CE	$V_{OUT}$					
Low	OFF							
High	ON							
Connect CE pin with $V_{DD}$ pin, when it is not used.								
6	Sub	Substrate. The 6pin must be connected to GND.						
7	$V_{DD}$	Voltage-Supply pin						

**Absolute Maximum Ratings** (Except where noted otherwise Ta=25°C)

Item	Symbol	Ratings	Units
Storage temperature	T <sub>STG</sub>	-55~+150	°C
Supply voltage	V <sub>DD</sub>	6.5	V
CE input voltage	V <sub>CE</sub>	-0.3~V <sub>DD</sub> +0.3	V
Output voltage	V <sub>OUT</sub>	-0.3~V <sub>DD</sub> +0.3	V
Output current	I <sub>omax.</sub>	600	mA
Power dissipation	P <sub>d</sub>	950 (Note1)	mW

Note1 : With the double sided PC board of glass epoxy. Copper plane 80%, 192 × 142 × 1.2mm

**Recommended Operating Conditions** (Except where noted otherwise Ta=25°C)

Item	Symbol	Ratings	Units
Operating ambient temperature	T <sub>JOP</sub>	-40~85	°C
Operating voltage	V <sub>OP</sub>	2~6	V
Output current	I <sub>o</sub>	0~500	mA

**Electrical Characteristics 1** (Except where noted otherwise V<sub>DD</sub>=V<sub>OUT</sub>(typ.)+1V, V<sub>CE</sub>=V<sub>DD</sub>, Ta=25°C)

Item	Symbol	Measurement conditions	Min.	Typ.	Max.	Units
Input current (OFF)	I <sub>DDoff</sub>	V <sub>CE</sub> =0V		0.1	1.0	μA
No-load input current	I <sub>DD</sub>	I <sub>OUT</sub> =0mA		45	70	μA
Output voltage	V <sub>OUT</sub>	I <sub>OUT</sub> =30mA	×0.98		×1.02	V
Line regulation	V <sub>LINE</sub>	V <sub>DD</sub> =V <sub>o</sub> (typ.)+0.5~6V, I <sub>OUT</sub> =30mA (V <sub>OUT</sub> ≤1.6V, V <sub>DD</sub> =2.2~6V)		0.02	0.10	%/V
Load regulation	V <sub>LOAD</sub>	1mA≤I <sub>OUT</sub> ≤500mA		50	140	mV
Dropout voltage	V <sub>io</sub>	Please refer to another page				V
Ripple rejection 1 (Note2)	RR1	f=1kHz, V <sub>ripple</sub> =0.5V, I <sub>OUT</sub> =30mA (V <sub>OUT</sub> ≤1.7V, V <sub>DD</sub> =V <sub>OUT</sub> +1.2V)		70		dB
Ripple rejection 2 (Note2)	RR2	f=10kHz, V <sub>ripple</sub> =0.5V, I <sub>OUT</sub> =30mA (V <sub>OUT</sub> ≤1.7V, V <sub>DD</sub> =V <sub>OUT</sub> +1.2V)		50		dB
V <sub>OUT</sub> temperature coefficient (Note2)	ΔV <sub>OUT</sub> /ΔT	I <sub>OUT</sub> =30mA -40≤T <sub>OP</sub> ≤85°C		±100		ppm/°C
Output noise voltage (Note2)	V <sub>n</sub>	f <sub>BW</sub> =10~100kHz I <sub>OUT</sub> =30mA		30		μV <sub>rms</sub>
Output short-circuit current (Note2)	I <sub>lim</sub>	V <sub>OUT</sub> =0V		40		mA
CE pull-down resistance	R <sub>pd</sub>		0.7	2	8	MΩ
CE H threshold voltage	V <sub>CEH</sub>		1.5		V <sub>DD</sub>	V
CE L threshold voltage	V <sub>CEL</sub>		0		0.3	V
Output NMOS ON resistance	R <sub>DON</sub>	V <sub>CE</sub> =0V V <sub>DD</sub> =4V(V <sub>OUT</sub> <3V)		30		Ω

Note2 : The item is guaranteed by design.

**Electrical Characteristics 2** (Except where noted otherwise  $V_{DD}=V_{OUT}(typ.)+1V$ ,  $V_{CE}=V_{DD}$ ,  $T_a=25^{\circ}C$ )

Rank	Item							
	Output voltage				Dropout voltage			
	$V_{OUT}$ (V)				$V_{io}$ (V)			
	Measurement conditions	Min.	Typ.	Max.	Measurement conditions	Min.	Typ.	Max.
1.5		1.470	1.500	1.530	(Note3)			
1.6		1.568	1.600	1.632				
1.7		1.666	1.700	1.734				
1.8		1.764	1.800	1.836				
1.9		1.862	1.900	1.938				
2.0		1.960	2.000	2.040				
2.1		2.058	2.100	2.142	$2.1V \leq V_{OUT} \leq 2.7V$ $I_{OUT}=500mA$	0.40	0.70	
2.2		2.156	2.200	2.244				
2.3		2.254	2.300	2.346				
2.4		2.352	2.400	2.448				
2.5		2.450	2.500	2.550				
2.6		2.548	2.600	2.652				
2.7		2.646	2.700	2.754				
2.8		2.744	2.800	2.856				
2.9		2.842	2.900	2.958				
3.0		2.940	3.000	3.060				
3.1		3.038	3.100	3.162	$2.8V \leq V_{OUT} \leq 5.0V$ $I_{OUT}=500mA$	0.30	0.60	
3.2		3.136	3.200	3.264				
3.3		3.234	3.300	3.366				
3.4		3.332	3.400	3.468				
3.5		3.430	3.500	3.570				
3.6		3.528	3.600	3.672				
3.7		3.626	3.700	3.774				
3.8		3.724	3.800	3.876				
3.9		3.822	3.900	3.978				
4.0		3.920	4.000	4.080				
4.1		4.018	4.100	4.182				
4.2		4.116	4.200	4.284				
4.3		4.214	4.300	4.386				
4.4		4.312	4.400	4.488				
4.5		4.410	4.500	4.590				
4.6		4.508	4.600	4.692				
4.7		4.606	4.700	4.794				
4.8		4.704	4.800	4.896				
4.9		4.802	4.900	4.998				
5.0		4.900	5.000	5.100				

Note3 : The item is not guaranteed in the model less than  $V_{O}=2.0V$ .

## Measuring Circuit

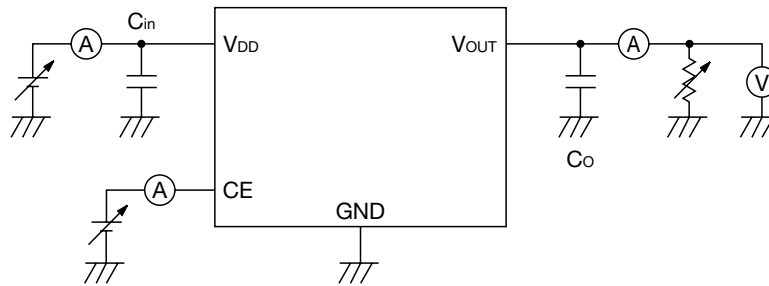

## Application Circuit

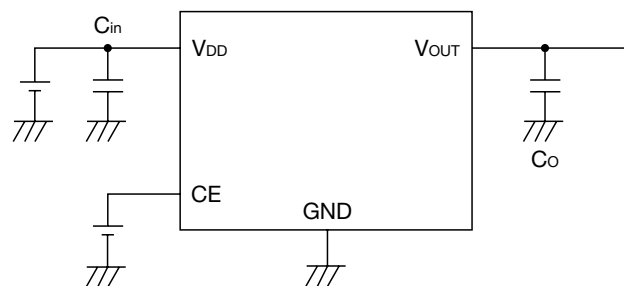

(reference example of external parts)

- Output capacitor Co                      Ceramic capacitor 1.0 $\mu$ F
- Input capacitor Cin                        Ceramic capacitor 1.0 $\mu$ F

★ Temperature Characteristics : B

· Note

1. The output capacitor is required between output and GND to prevent oscillation.
2. The ESR of capacitor must be defined in ESR stability area.  
It is possible to use a ceramic capacitor without ESR resistance for output.  
The ceramic capacitor must be used more than 1.0 $\mu$ F and B temperature characteristics.
3. The wire of V<sub>CC</sub> and GND is required to print full ground plane for noise and stability.
4. The input capacitor must be connected a distance of less than 1cm from input pin.
5. In case the output voltage is above the input voltage, the overcurrent flow by internal parastic diode from output to input.

**Characteristics (Vo=3.0V)** (Except where noted otherwise  $V_{DD}=V_{OUT}(\text{typ.}) + 1V$ ,  $V_{CE}=V_{DD}$ ,  $T_a=25^\circ\text{C}$ )

**Output voltage - Input voltage**

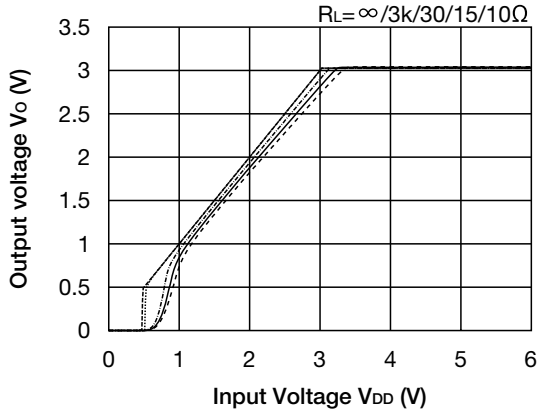

**Input current - Input voltage**

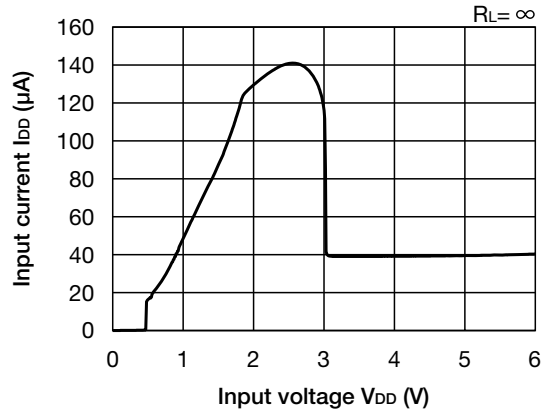

**Load regulation**

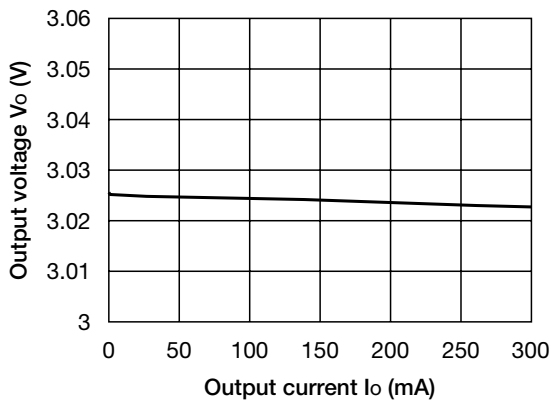

**Line regulation**

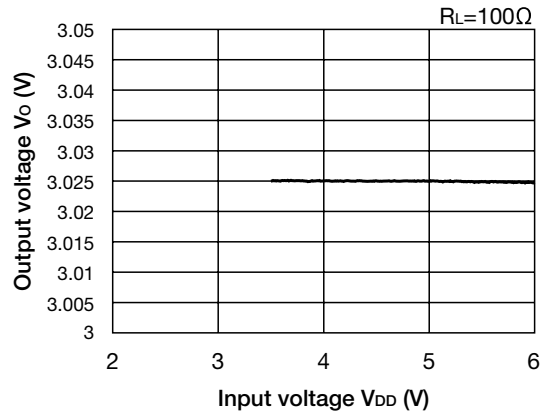

**Droopout voltage - Output current**

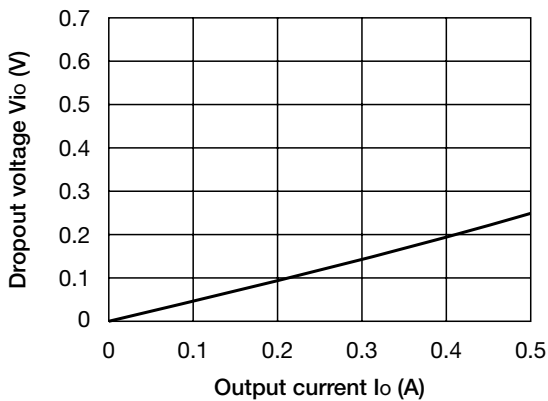

• Any products mentioned in this catalog are subject to any modification in their appearance and others for improvements without prior notification.  
 • The details listed here are not a guarantee of the individual products at the time of ordering. When using the products, you will be asked to check their specifications.

**Characteristics (Vo=3.0V)** (Except where noted otherwise VDD=VOUT (typ.) +1V, VCE=VDD, Ta=25°C)

**Ripple rejection**

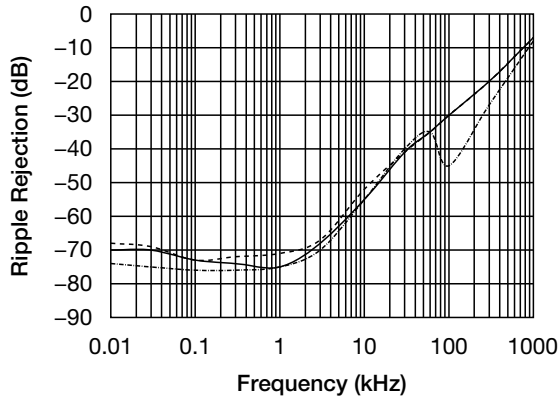

**Output voltage - Ambient temperature**

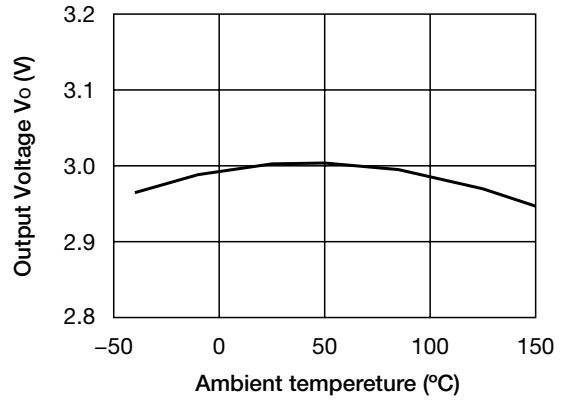

**Load transient response (Io=1→250mA)**

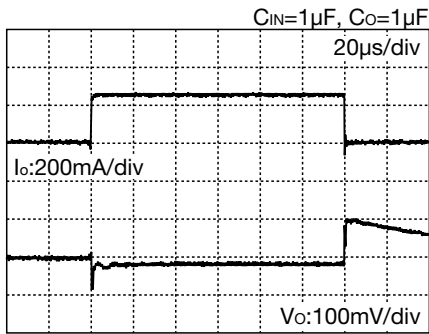

**Load transient response (Io=1→500mA)**

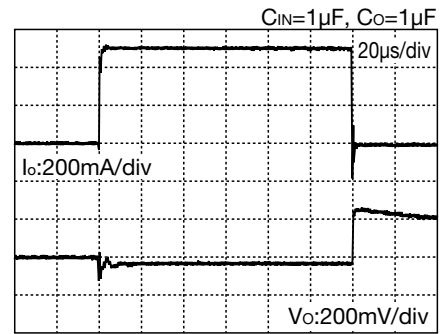

**ESR stable area**

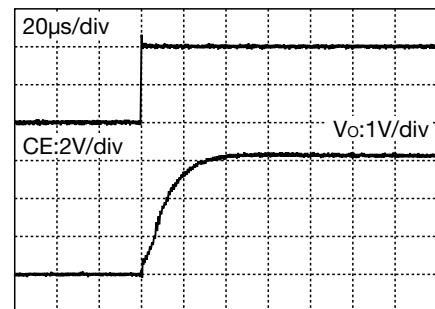
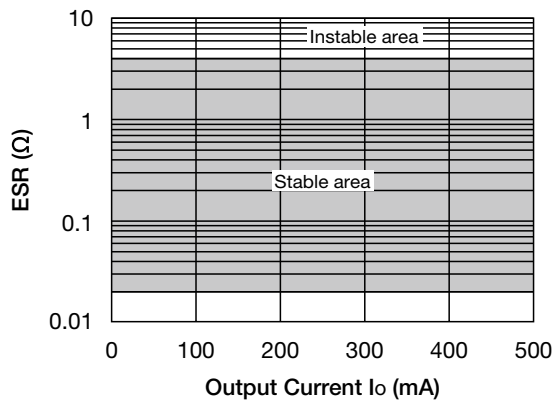

**Characteristics (Vo=5.0V)** (Except where noted otherwise  $V_{DD}=V_{OUT} (typ.) + 1V$ ,  $V_{CE}=V_{DD}$ ,  $T_a=25^{\circ}C$ )

**Output voltage - Input voltage**

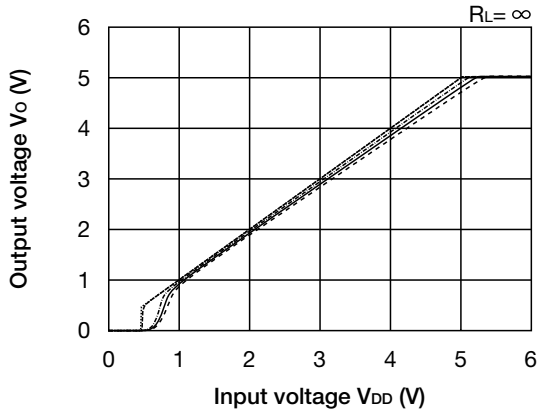

**Input current - Input voltage**

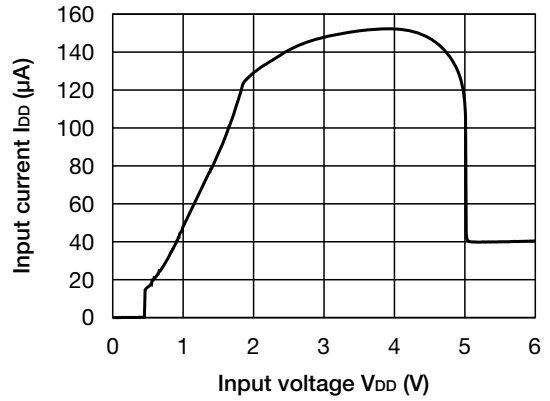

**Load regulation**

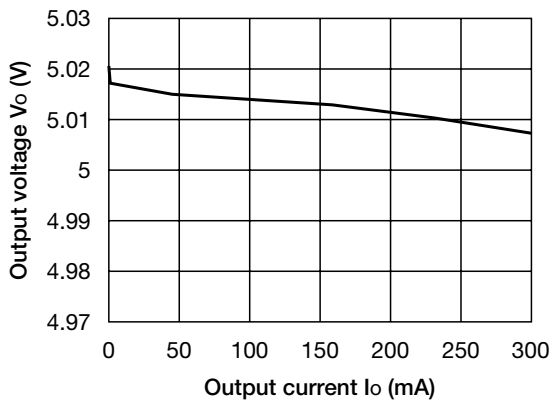

**Line regulation**

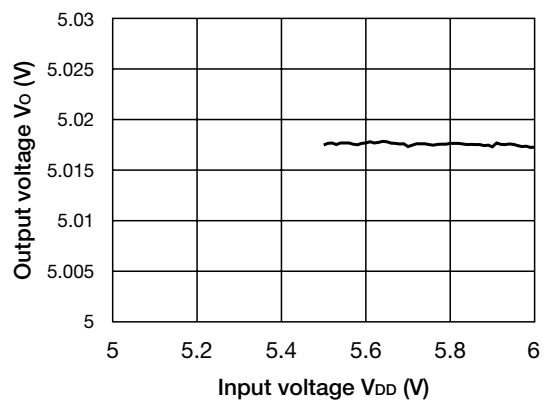

**Doroput voltage - Output current**

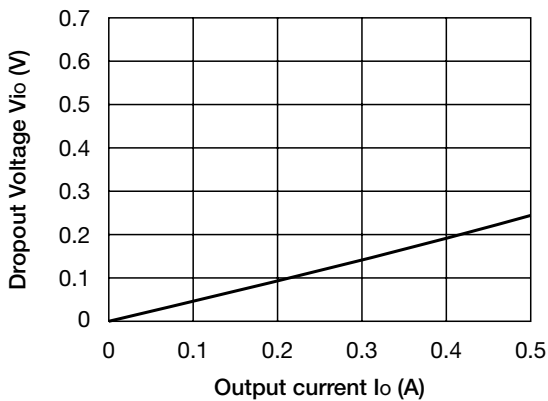

• Any products mentioned in this catalog are subject to any modification in their appearance and others for improvements without prior notification.  
 • The details listed here are not a guarantee of the individual products at the time of ordering. When using the products, you will be asked to check their specifications.